

COCKTAIL

110-019131400960r

COCKTAIL L VOLARE SUSPENSION WITH 2-PH VOLARE ADAPTER made of aluminium, black, similar to RAL 9005, shade made of hand-blown glass smoked grey, beam 90°, light output direct, with converter, max. 580mA, dimmability: Loxone Air, cable black, fabric, adapter/ceiling base grey, pendant length 2000mm, IP20



DRAWING

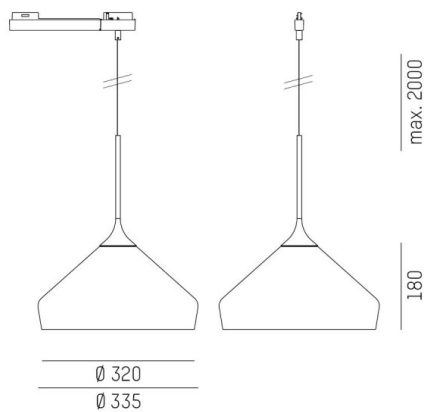

TECHNICAL DETAILS

System perform. [W]	10
Bulb type	LED
Luminous flux [lm]	250
Current sec. [mA]	580
Colour temp. [K]	3000K
CRI	>90
Optics	hand-blown glass
Converter	with converter
Light output	direct
Beam angle [°]	90°
Voltage [V]	220-240V 50/60HZ
Material	aluminium
Length [mm]	180
Height [mm]	405
Pendant length [mm]	2000
Diameter [mm]	335
IP protection class	IP20
Voltage class	protection cl. II
Net weight [kg]	1,65
Colour lamp	black
RAL	9005
Colour of glass/shade	smoked grey
Colour adapter/ceiling base	grey
Electric wire	black, fabric
EAN-Number	9010870351967
Lifetime [h]	50 000 L80 B10
Energy efficiency cl.	E

LIGHT DISTRIBUTION CURVE

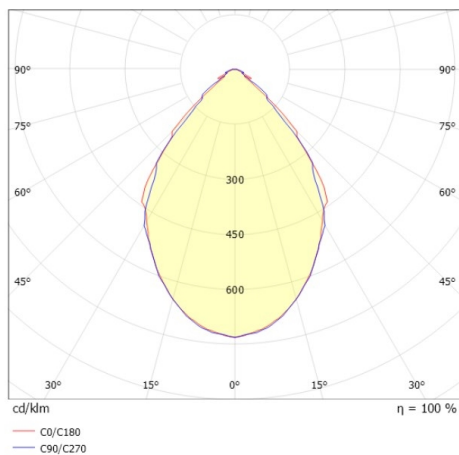

The values are rated values. Power and luminous flux are initially subject to a tolerance of +/- 10%. Colour temperature tolerance: +/- 150 K. The values apply to an ambient temperature of 25°C unless otherwise specified.