

ENERGY

121-2217251539

ENERGY 2180 RECESSED DOWNLIGHT made of aluminium, white, light output direct, with converter, max. 250/350/400/500mA, dimmability: not dimmable, IP44/IP20 adjustable by means of DIP-SWITCH converter



DIP-SWITCH Einstellungen 121-2217251539				
I out	W tot	Kelvin	Lumen	CRI
250	9	3000K	1065	CRI 90
350	13	3000K	1491	CRI 90
400	14	3000K	1688	CRI 90
500	19	3000K	2073	CRI 90

DRAWING

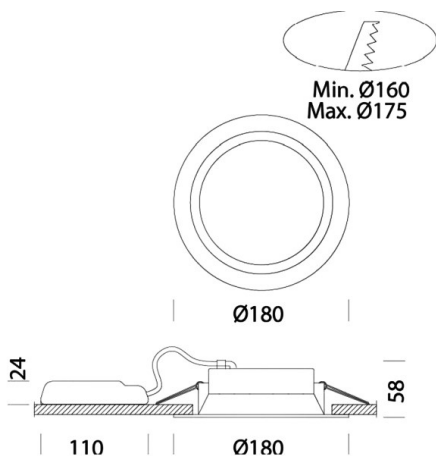

TECHNICAL DETAILS

System perform. [W]	9/13/14/19
Bulb type	LED
Luminous flux [lm]	1097/1536/1702/2135
Current sec. [mA]	250/350/400/500
Colour temp. [K]	3000K
CRI	>90
Converter	with converter
Dimming	not dimmable
Light output	direct
Voltage [V]	220-240V 50/60Hz
Material	aluminium
Height [mm]	58
Diameter [mm]	180
Ceiling cutout [mm]	160-175
Recess depth [mm]	88
IP protection class	IP44/IP20
Voltage class	protection cl. II
Shock resistance	IK07
Net weight [kg]	0,44
Colour lamp	white
EAN-Number	8016535144531
Lifetime [h]	55 000 L80 B20
Energy efficiency cl.	E

LIGHT DISTRIBUTION CURVE

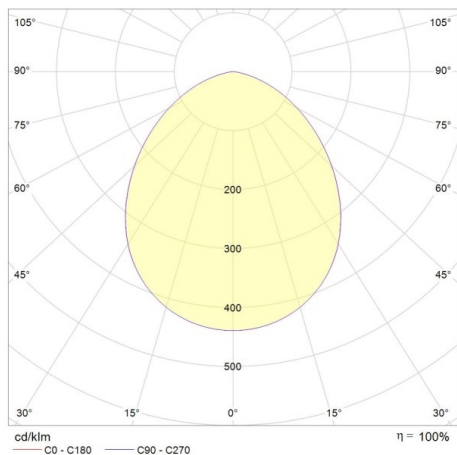

The values are rated values. Power and luminous flux are initially subject to a tolerance of +/- 10%. Colour temperature tolerance: +/- 150 K. The values apply to an ambient temperature of 25°C unless otherwise specified.