

RIDE SPOT 2

577-006020123050

RIDE SPOT 2 R RECESSED SPOTLIGHT made of die-cast aluminium, white, similar to RAL 9016, high quality glass lens beam 12°, light output direct, swiveling 350°, tilting 35°, with converter, dimmability: not dimmable, IP20



DRAWING

68 mm, ET: 75mm

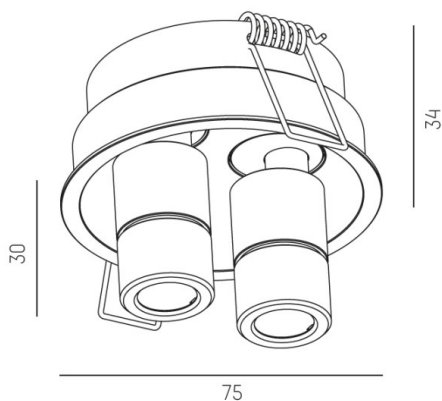

TECHNICAL DETAILS

System perform. [W]	7
Bulb type	LED
Luminous flux [lm]	290
Colour temp. [K]	2700K
CRI	>90
Optics	high quality glass lens
Designer	INHOUSE
Converter	with converter
Dimming	not dimmable
Light output	direct
Beam angle [°]	12°
Voltage [V]	220-240V 50/60Hz
Material	die-cast aluminium
Length [mm]	75
Height [mm]	64
Diameter [mm]	75
Ceiling cutout [mm]	68
Ceiling thickness [mm]	1-20mm
Recess depth [mm]	75
IP protection class	IP20
Voltage class	protection cl. II
Net weight [kg]	0,76
Colour lamp	white
RAL	9016
EAN-Number	9008905677694
Lifetime [h]	L80 B10 50 000
Energy efficiency cl.	G
No. of luminaires B16A	50

LIGHT DISTRIBUTION CURVE

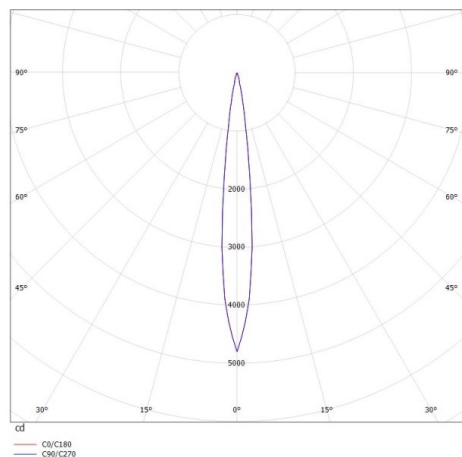

The values are rated values. Power and luminous flux are initially subject to a tolerance of +/- 10%. Colour temperature tolerance: +/- 150 K. The values apply to an ambient temperature of 25°C unless otherwise specified.