

RIDE

577-00802202908d

RIDE BLIND SI WALL / CEILING LUMINAIRE made of die-cast aluminium, natural anodised, light output indirect, with converter, dimmability: DALI, through wiring 3x0,75mm² + 2x0,5mm², IP20



DRAWING

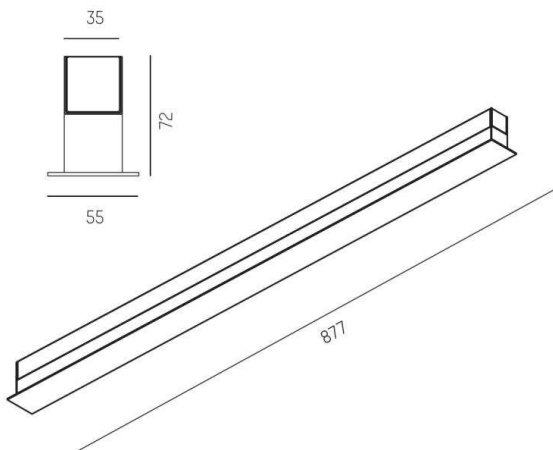

TECHNICAL DETAILS

System perform. [W]	15
Bulb type	LED
Luminous flux [lm]	750
Colour temp. [K]	3000K
CRI	>90
Converter	with converter
Light output	indirect
Voltage [V]	220-240V 50/60Hz
Through wiring	3x0,75mm ² + 2x0,5mm ²
Material	die-cast aluminium
Length [mm]	877
Width [mm]	55
Height [mm]	72
IP protection class	IP20
Voltage class	protection cl. I
Shock resistance	IK03
Net weight [kg]	1,97
Colour lamp	natural anodised
EAN-Number	9010506087512
Lifetime [h]	L80 B10 50 000
Energy efficiency cl.	E
No. of luminaires B16A	50

LIGHT DISTRIBUTION CURVE

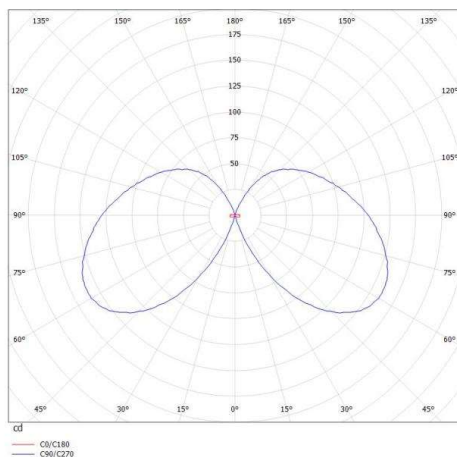

The values are rated values. Power and luminous flux are initially subject to a tolerance of +/- 10%. Colour temperature tolerance: +/- 150 K. The values apply to an ambient temperature of 25°C unless otherwise specified.