

VIBO

668-004010823460

VIBO VOLARE TRACK SPOTLIGHT WITH 2 PH VOLARE ADAPTER made of aluminium, black matt, similar to RAL 9005, stray light-free hexagonal lens beam 35°, light output direct, UGR <16, swiveling 350°, tilting 30°, with converter, max. 500mA, dimmability: not dimmable, adapter/ceiling base grey, IP20



DRAWING

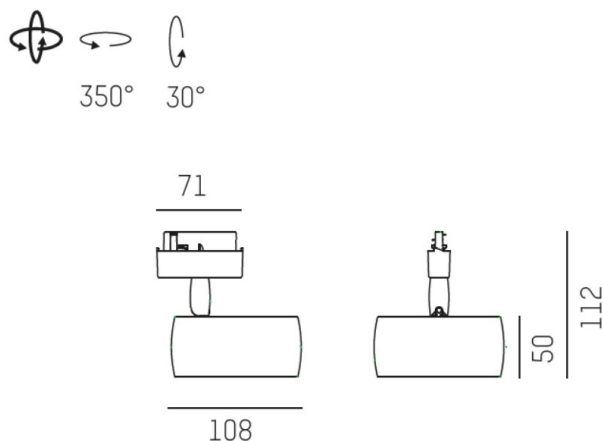

TECHNICAL DETAILS

System perform. [W]	8
Bulb type	LED
Luminous flux [lm]	340
Current sec. [mA]	500
Colour temp. [K]	2700K
CRI	>90
UGR	<16
Optics	stray light-free hexagonal lens
Designer	INHOUSE
Converter	with converter
Dimming	not dimmable
Light output	direct
Beam angle [°]	35°
Voltage [V]	220-240V 50/60Hz
Material	aluminium
Length [mm]	71
Height [mm]	112
Diameter [mm]	108
Troat [mm]	112
IP protection class	IP20
Voltage class	protection cl. I
Net weight [kg]	0,60
Colour lamp	black matt
RAL	9005
Colour adapter/ceiling base	grey
EAN-Number	9008905782183
Lifetime [h]	L80 B10 50 000
Energy efficiency cl.	G
No. of luminaires B16A	50

LIGHT DISTRIBUTION CURVE

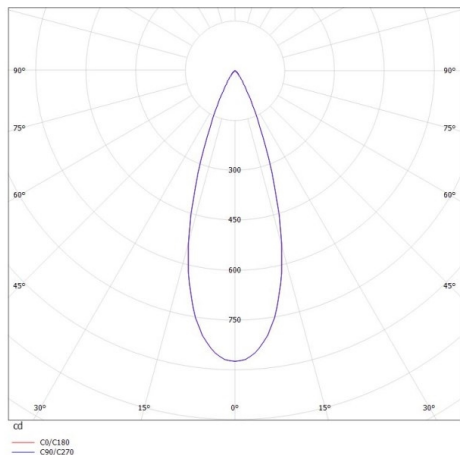

The values are rated values. Power and luminous flux are initially subject to a tolerance of +/- 10%. Colour temperature tolerance: +/- 150 K. The values apply to an ambient temperature of 25°C unless otherwise specified.