

MAGNETICS

708-01602002906d

MAGNETICS SPHERE M SD TRACK SPOTLIGHT WITH 24V ADAPTER made of hand-blown glass, black, similar to RAL 9005, satined glass satined, beam 330°, light output direct, UGR <16, without converter, max. 195mA, dimmability: DALI, adapter/ceiling base black, IP20



DRAWING

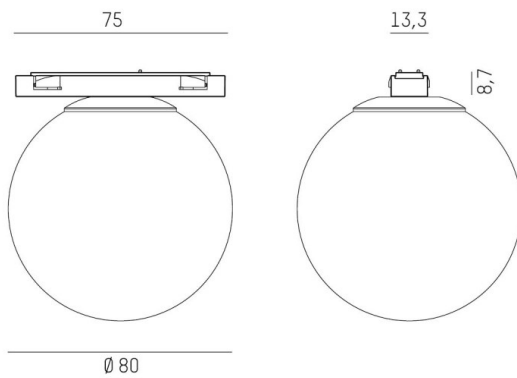

TECHNICAL DETAILS

System perform. [W]	5
Bulb type	LED
Luminous flux [lm]	290
Current sec. [mA]	195
Colour temp. [K]	3000K
CRI	>90
UGR	<16
Optics	satined glass
Designer	INHOUSE
Converter	without converter
Light output	direct
Beam angle [°]	330°
Voltage [V]	24 VDC
Material	hand-blown glass
Length [mm]	80
Width [mm]	13,7
Height [mm]	88,60
Diameter [mm]	80
IP protection class	IP20
Voltage class	protection cl. III
Shock resistance	IK00
Net weight [kg]	0,41
Colour lamp	black
RAL	9005
Colour of glass/shade	satined
Colour adapter/ceiling base	black
EAN-Number	9010870398320
Lifetime [h]	L80 B10 50 000
Energy efficiency cl.	E

LIGHT DISTRIBUTION CURVE

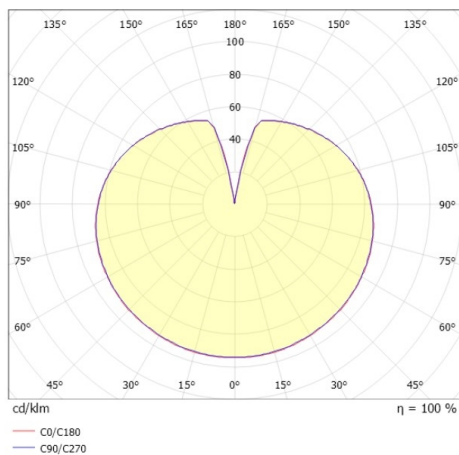

The values are rated values. Power and luminous flux are initially subject to a tolerance of +/- 10%. Colour temperature tolerance: +/- 150 K. The values apply to an ambient temperature of 25°C unless otherwise specified.