

LOG 50 SYSTEM

715-170611011404d

LOG 50 WALLWASHER EINSATZ LIGHT INSERT made of metal, decor grey, Lens optics with vacuum deposited synthetic reflector beam asymmetric, light output direct, with converter, max. 700mA, dimmability: DALI, through wiring 3x1,5mm<sup>2</sup> + 2x0,75mm<sup>2</sup>, IP20

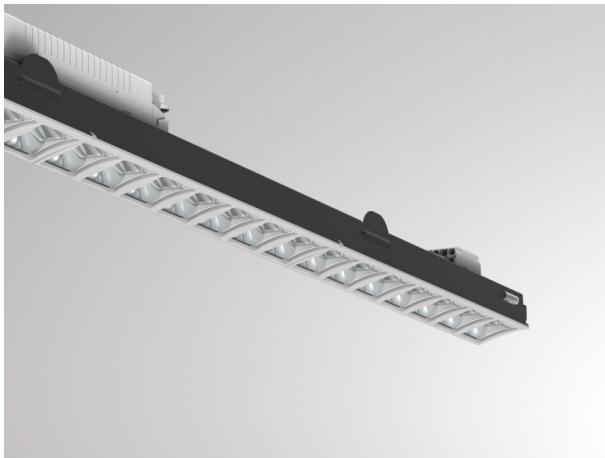

DRAWING

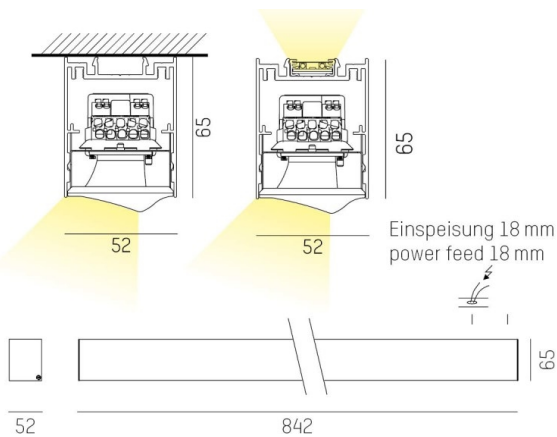

TECHNICAL DETAILS

System perform. [W]	20
Bulb type	LED
Luminous flux [lm]	2150
Current sec. [mA]	700
Colour temp. [K]	4000K
CRI	>80
Optics	Lens optics with vacuum deposited synthetic reflector
Designer	INHOUSE
Converter	with converter
Light output	direct
Beam angle [°]	asymmetrisch
Voltage [V]	220-240V 50/60Hz
Through wiring	3x1,5mm <sup>2</sup> + 2x0,75mm <sup>2</sup>
Material	metal
Height [mm]	55
IP protection class	IP20
Voltage class	protection cl. I
Net weight [kg]	1,09
Colour decor	grey
EAN-Number	9010870551336
Lifetime [h]	L80 B10 50 000
Energy efficiency cl.	C
No. of luminaires B16A	50

LIGHT DISTRIBUTION CURVE

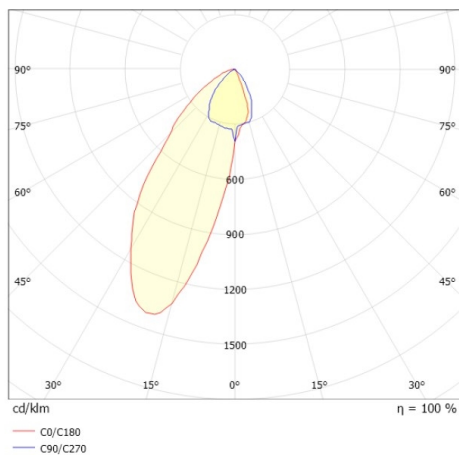

The values are rated values. Power and luminous flux are initially subject to a tolerance of +/- 10%. Colour temperature tolerance: +/- 150 K. The values apply to an ambient temperature of 25°C unless otherwise specified.