

LOG 50 SYSTEM

715-1706220119060

LOG 50 Wallwasher Einsatz D/ID LIGHT INSERT made of metal, decor black, Lens optics with vacuum deposited synthetic reflector beam asymmetric, light output direct / indirect, with converter, max. 700/550mA, dimmability: not dimmable, through wiring 3x1,5mm², IP20

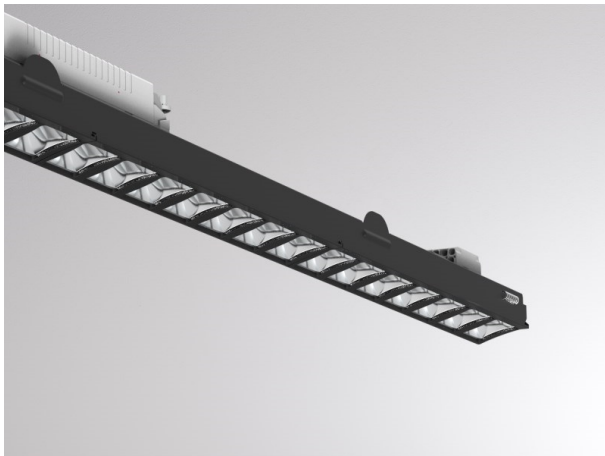

DRAWING

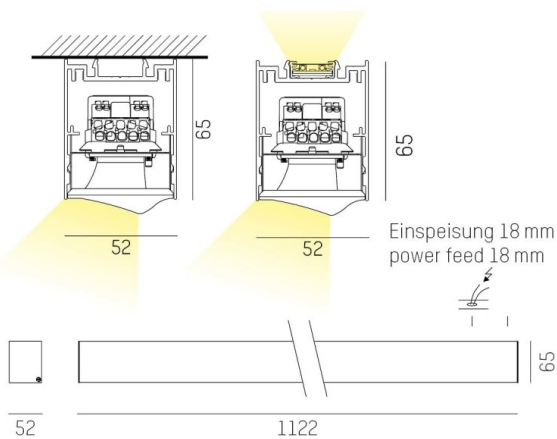

TECHNICAL DETAILS

System perform. [W]	27
Bulb type	LED
Luminous flux [lm]	2680
Current sec. [mA]	700/550
Colour temp. [K]	3000K
CRI	>80
Optics	Lens optics with vacuum deposited synthetic reflector
Designer	INHOUSE
Converter	with converter
Dimming	not dimmable
Light output	direct / indirect
Beam angle [°]	asymmetrisch
Voltage [V]	220-240V 50/60Hz
Through wiring	3x1,5mm²
Material	metal
Length [mm]	1122
Height [mm]	55
IP protection class	IP20
Voltage class	protection cl. I
Net weight [kg]	1,41
Colour decor	black
EAN-Number	9010870553101
Lifetime [h]	L80 B10 50 000
Energy efficiency cl.	C
No. of luminaires B16A	25

LIGHT DISTRIBUTION CURVE

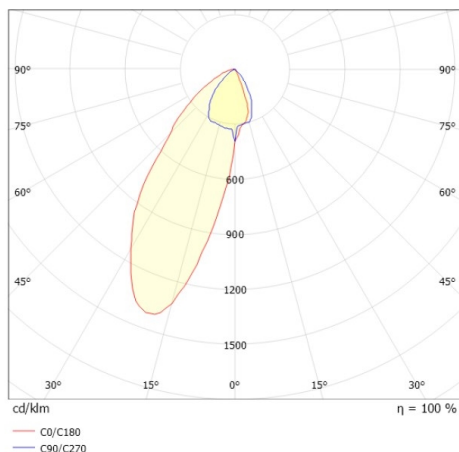

The values are rated values. Power and luminous flux are initially subject to a tolerance of +/- 10%. Colour temperature tolerance: +/- 150 K. The values apply to an ambient temperature of 25°C unless otherwise specified.