

LOG 50 RING

722-0201a0111905000

LOG 50 RING 90° PD SUSPENSION made of aluminium, white, similar to RAL 9016, sated PMMA opal diffuser light output direct, with converter, max. 350mA, dimmability: not dimmable, through wiring 3x1,5mm², pendant length 3000mm, IP20



DRAWING

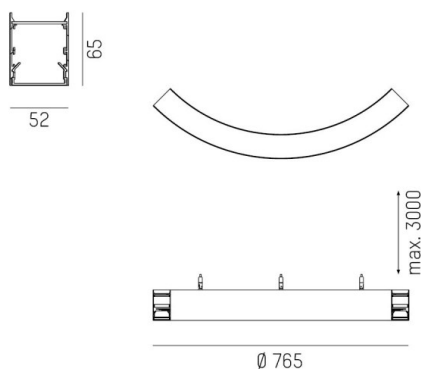

LIGHT DISTRIBUTION CURVE



TECHNICAL DETAILS

System perform. [W]	7
Bulb type	LED
Luminous flux [lm]	860
Current sec. [mA]	350
Colour temp. [K]	3000K
CRI	>80
Optics	PMMA opal diffuser
Designer	INHOUSE
Converter	with converter
Dimming	not dimmable
Light output	direct
Voltage [V]	220-240V 50/60Hz
Through wiring	3x1,5mm ²
Material	aluminium
Length [mm]	382,5
Width [mm]	52
Height [mm]	65
Pendant length [mm]	3000
Diameter [mm]	765
IP protection class	IP20
Voltage class	protection cl. I
Shock resistance	IK03
Net weight [kg]	2,51
Colour lamp	white
RAL	9016
EAN-Number	9010870194519
Lifetime [h]	L80 B10 50 000
Energy efficiency cl.	C
No. of luminaires B16A	50



The values are rated values. Power and luminous flux are initially subject to a tolerance of +/- 10%. Colour temperature tolerance: +/- 150 K. The values apply to an ambient temperature of 25°C unless otherwise specified.