

LOG 50 RING

722-0201b021190500d

LOG 50 RING 90° PD SUSPENSION made of aluminium, white, similar to RAL 9016, sated PMMA opal diffuser light output direct, with converter, max. 700mA, dimmability: DALI, through wiring 3x1,5mm² + 2x0,75mm², pendant length 3000mm, IP20



DRAWING

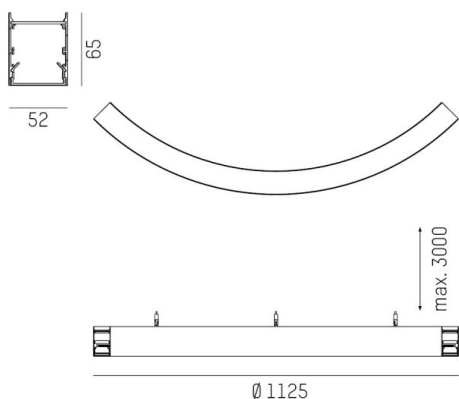

TECHNICAL DETAILS

System perform. [W]	19
Bulb type	LED
Luminous flux [lm]	2590
Current sec. [mA]	700
Colour temp. [K]	3000K
CRI	>80
Optics	PMMA opal diffuser
Designer	INHOUSE
Converter	with converter
Light output	direct
Voltage [V]	220-240V 50/60Hz
Through wiring	3x1,5mm ² + 2x0,75mm ²
Material	aluminium
Length [mm]	562,5
Width [mm]	52
Height [mm]	65
Pendant length [mm]	3000
Diameter [mm]	1125
IP protection class	IP20
Voltage class	protection cl. I
Shock resistance	IK03
Net weight [kg]	3,33
Colour lamp	white
RAL	9016
EAN-Number	9010870199811
Lifetime [h]	L80 B10 50 000
Energy efficiency cl.	C
No. of luminaires B16A	50

LIGHT DISTRIBUTION CURVE

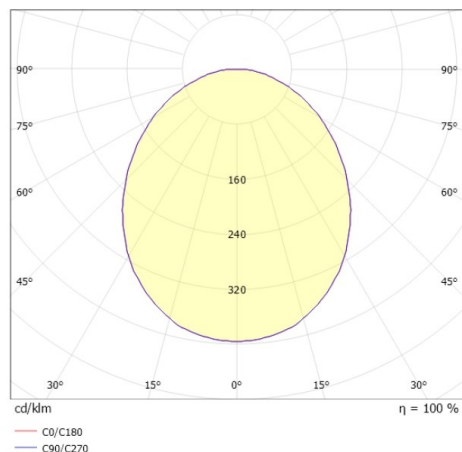

The values are rated values. Power and luminous flux are initially subject to a tolerance of +/- 10%. Colour temperature tolerance: +/- 150 K. The values apply to an ambient temperature of 25°C unless otherwise specified.