

LOG 2.1. SYSTEM

728-30500111350d

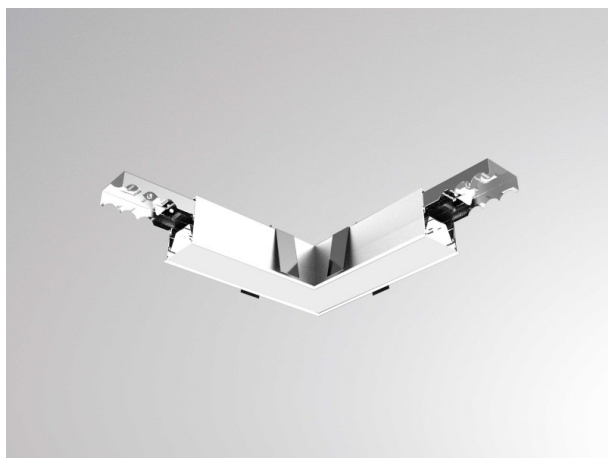

DRAWING

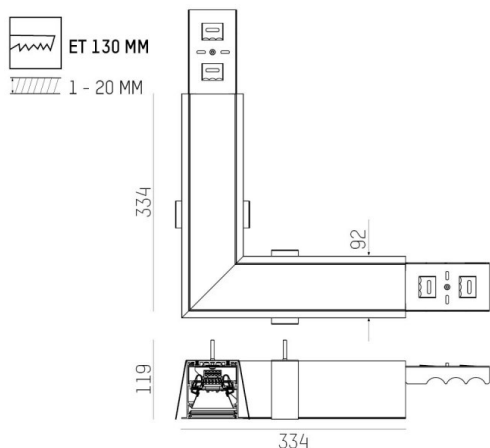

LIGHT DISTRIBUTION CURVE

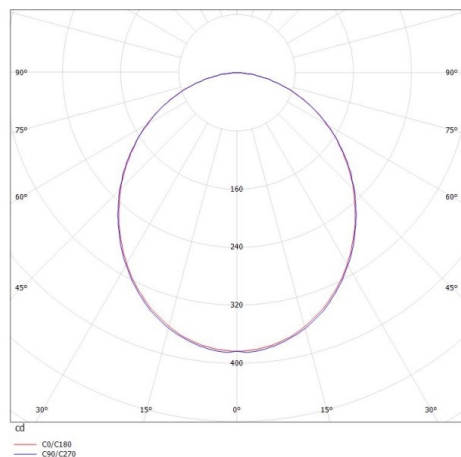

TECHNICAL DETAILS

System perform. [W]	9
Bulb type	LED
Luminous flux [lm]	990
Colour temp. [K]	2700K
CRI	>80
Optics	PMMA opal diffuser
Designer	INHOUSE
Converter	with converter
Light output	direct
Voltage [V]	220-240V 50/60Hz
Through wiring	3x1,5mm ² + 2x0,75mm ²
Material	die-cast aluminium
Length [mm]	334X334
Width [mm]	92
Height [mm]	119
Ceiling thickness [mm]	1-20
Recess depth [mm]	130
IP protection class	IP20
Voltage class	protection cl. I
Net weight [kg]	3,13
Colour lamp	white
RAL	9016
EAN-Number	9010506141399
Lifetime [h]	L80 B10 50 000
Energy efficiency cl.	D
No. of luminaires B16A	50



The values are rated values. Power and luminous flux are initially subject to a tolerance of +/- 10%. Colour temperature tolerance: +/- 150 K. The values apply to an ambient temperature of 25°C unless otherwise specified.