

AUSTRIA

HEADOFFICE
WELS

Office & Showroom
Europastraße 45
4600 Wels, Austria
+43 7242 698-0
office@moltoluce.com

PRODUCTION
WEISSKIRCHEN

Office
Gewerbepark 6 + 10
4616 Weißkirchen, Austria
+43 7243 60063
office.weisskirchen@moltoluce.com

VIENNA

Office & Showroom
Vorarlberger Allee 28
1230 Vienna, Austria
+43 1 6160300
office.wien@moltoluce.com

GRAZ

Office
Robert-Viertl-Straße 2
8055 Graz, Austria
+43 316 672525-0
office.graz@moltoluce.com

INNSBRUCK

Office
Orbis Office, Resselstraße 33
6020 Innsbruck, Austria
+43 512 345688
office.innsbruck@moltoluce.com

GERMANY

MUNICH

Office & Showroom
Walter-Gropius-Straße 23
80807 Munich, Germany
+49 89 4520565-0
office.muenchen@moltoluce.com

COLOGNE

Office & Showroom
Schanzenstraße 39 D14
51063 Cologne, Germany
+49 221 222882-0
office.koeln@moltoluce.com

HAMBURG

Office & Showroom
Wandsbeker Allee 77
22041 Hamburg, Germany
+49 40 2847850-1
office.hamburg@moltoluce.com

SWITZERLAND

LENZBURG

Office
Niederlenzerstrasse 25
5600 Lenzburg, Switzerland
+41 62 885 70 30
office.lenzburg@moltoluce.com

ITALY

BRESCIA

Office
Viale Duca D'Aosta 28
25135 Brescia, Italy
+39 030 2400679
office.brescia@moltoluce.com



MOLTOLUCE.COM



kat-molto-hk-24-25

V_002

COLLECTED EDITION
2024 | 25

LIGHTING SOLUTIONS FOR
HIGH QUALITY PROJECTS

MOLTO LUCE®

MOLTO LUCE®



Aus produktionstechnischen Gründen sind nicht alle unsere Serien in Creative Colours umsetzbar. Mögliche Produkte sind im Katalog mit diesem Symbol gekennzeichnet. Creative Colours werden ab Stückzahl 1 gegen Aufpreis produziert.

Not all of our series can be implemented in Creative Colours for production technology reasons. Potential products are labelled with this symbol in the catalogue. Creative Colours are produced from a quantity of 1 for an additional charge.

W	weiß	white	bianco	blanc
WO	weiß opal	white opal	bianco opale	blanc opal
WM	weiß matt	white mat	bianco opaco	blanc mat
G	grau	grey	grigio	gris
SG	rauchgrau	smoked grey	grigio fumo	gris fumé
AE	aluminium eloxiert	aluminium anodized	alluminio anodizzato	aluminium anodisé
N	nickel	nickel	nickel	nickel
Ch	chrom	chrome	cromo	chrome
P	perlchrom	pearl chrome	cromo satinato	chrome satiné
BC	schwarzchrom	black chrome	cromo nero	chrome noir
S	schwarz	black	nero	noir
BA	schwarz eloxiert gebürstet	black anodized brushed	nero anodizzato spazzolato	noir anodisé brossé
CA	champagner eloxiert gebürstet	champagne anodized brushed	champagne anodizzato spazzolato	champagne anodisé brossé
SA	schiefer eloxiert gebürstet	slate anodized brushed	ardesia anodizzato spazzolato	ardoise anodisé brossé
CH	champagner	champagner	champagne	champagne
R	rose	rose	rosa	rose
B	braun	brown	marrone	marron
AM	amber	amber	ambra	amber
K	kupfer	copper	rame	cuivre
G	gold	gold	oro	or
GM	weiß meliert	white mottled	bianco screziato	blanc chiné
WM	grau meliert	grey mottled	grigio screziato	gris chiné
AM	anthrazit meliert	anthracite mottled	antracite screziato	anthracite chiné

W.	Lichtfarbe	Light colour	Colore chiaro	Couleur de lumière
S	schaltbar	switchable	commutabile	commutable
D	DALI dim	DALI dimm	DALI dim	DALI dimm
P	PULS DALI dim	PULSE DALI dim	PULSE DALI dim	PULSE DALI dimm
B	SMART BLUETOOTH dim	SMART BLUETOOTH dim	SMART BLUETOOTH dim	SMART BLUETOOTH dimm
AC	Nottlicht 3h DALI dim	Emergency 3h DALI dim	Emergenza 3h DALI dim	Sécurité 3h DALI dimm
L	LOXONE AIR dim	LOXONE AIR dim	LOXONE AIR dim	LOXONE AIR dimm
C	CASAMBI dim	CASAMBI dim	CASAMBI dim	CASAMBI dim
20°	Ausstrahlwinkel	Beam angle	Angolo di radiazione	Angle de rayonnement
	dreh- und schwenkbar	twistable and pivoting	orientabile e girevole	orientable et pivotant
	drehbar	twistable	girevole	pivotant
	schwenkbar	pivoting	orientabile	orientable
	Deckenstärke	ceiling thickness	spessore soffitto	épaisseur du plafond
	Einbautiefe	recessed depth	profondità di montaggio	hauteur de montage
	Deckenausschnitt rund	ceiling cutout round	soffitto ritaglio rotondo	Découpe de plafond ronde
	Deckenausschnitt quadratisch	ceiling cutout square	soffitto ritaglio quadrata	Découpe de plafond quadratico
	PMMA Opaldiffuser flach	PMMA opal diffuser flat	PMMA diffusore opale piatto	PMMA diffuseur opale plat
	PMMA Opaldiffuser kubisch	PMMA opal diffuser cubic	PMMA diffusore opale cubo	PMMA diffuseur opale cubique
	PMMA Opaldiffuser rund	PMMA opal diffuser round	PMMA diffusore opale rotondo	PMMA diffuseur opale ronde
	Microprismatischer Diffuser	Microprismatic diffuser	Microprismatica diffusore	Microprismatique diffuseur
	zusätzliche Lichtfarben	additional light colours	colori di luce aggiuntivi	couleurs claires supplémentaires
	Sonderlichtfarben	special light colours	colori chiari speciali	couleurs claires spéciales
	Creative Colours	Creative Colours	Creative Colours	Creative Colours

QR-Code System

Klicken sie auf den QR-Code der Produkte und erhalten sie sämtliche benötigte Informationen wie z.B. Preise, Lagerstand, Datenblatt, Montageanleitungen, LTD Dateien, ULD-Dateien, 3-DS Dateien und Ausschreibungstexte auf ihrem PC.

Click on the QR code of the products and get all the information you need, such as prices, stock levels, data sheets, mounting instructions, LTD files, ULD files, 3-DS files and tender texts on your PC.

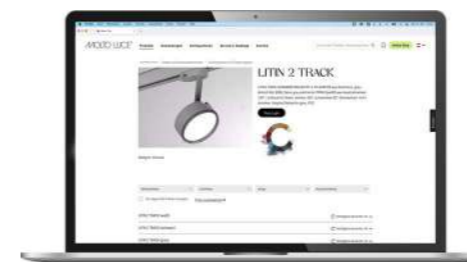

AUFBAU LEUCHTEN UND STRAHLER / SURFACE LUMINAIRES AND SPOTS

MORE PRODUCTS: NEXT PAGE →



PENDELLEUCHTEN / PENDANT LUMINAIRES

MORE PRODUCTS: NEXT PAGE →



EINBAU LEUCHTEN UND STRAHLER / RECESSED LUMINAIRES AND SPOTS

MORE PRODUCTS: NEXT PAGE →

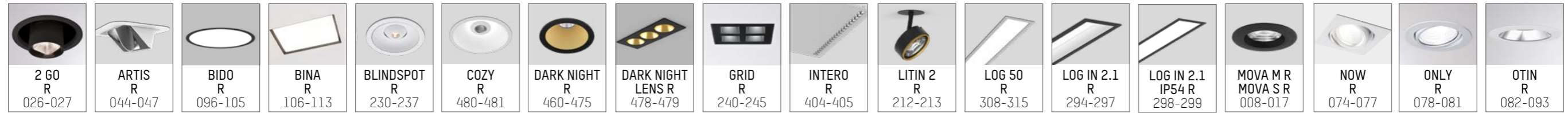

WANDLEUCHTEN / WALL LUMINAIRES

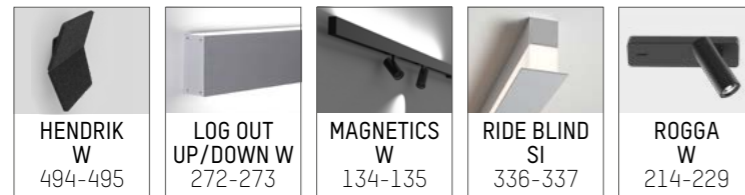

TISCH- UND STEHLEUCHTEN / TABLE- AND STAND LUMINAIRES

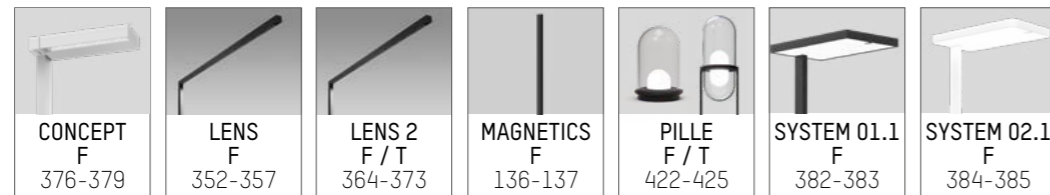

3-PHASEN SCHIENENSTRAHLER UND LEUCHTEN / 3-PHASE TRACK SPOTS AND LUMINAIRES



PROFILSYSTEME / PROFILE SYSTEMS



VOLARE 2-PHASEN SCHIENENSTRAHLER UND LEUCHTEN / VOLARE 2-PHASE TRACK SPOTS AND LUMINAIRE



AUFBAU LEUCHTEN UND STRAHLER / SURFACE LUMINAIRES AND SPOTS

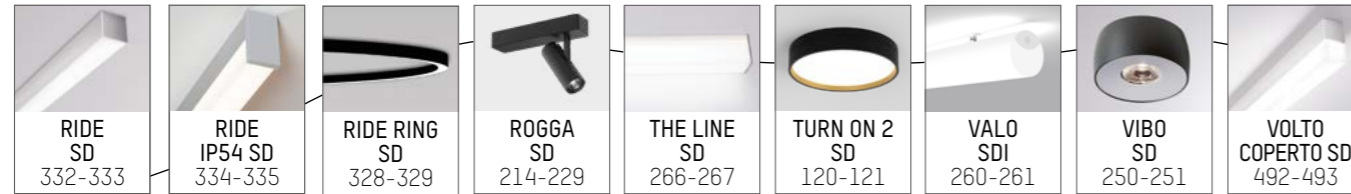

PENDELLEUCHTEN / PENDANT LUMINAIRES



EINBAU LEUCHTEN UND STRAHLER / RECESSED LUMINAIRES AND SPOTS

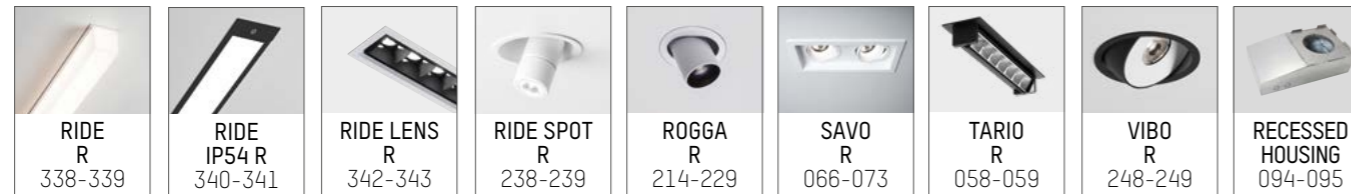

LEGENDE / LEGEND

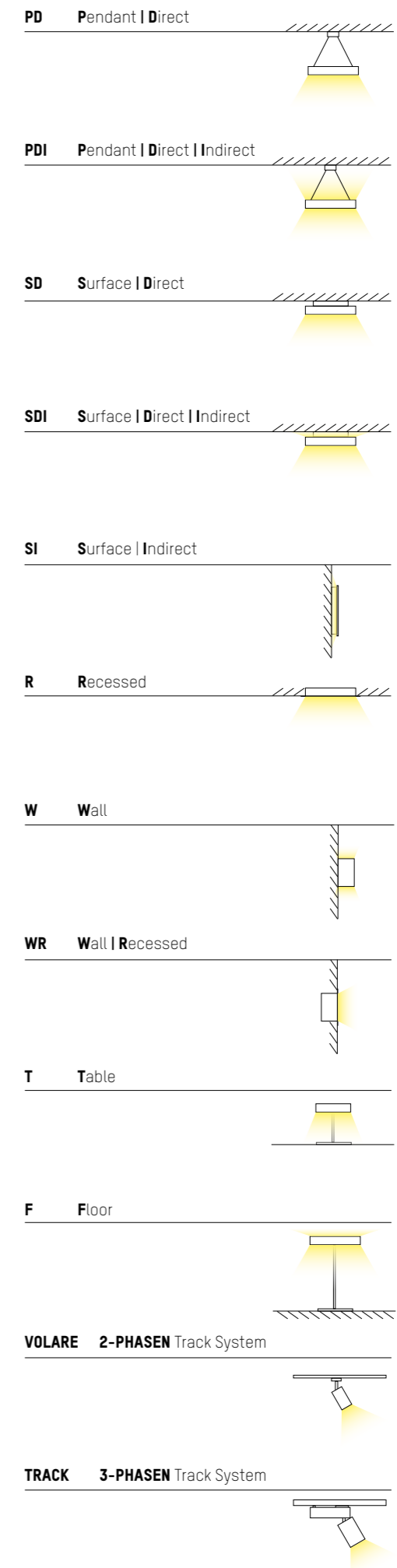



Unsere Lichtlösungen für Räume mit emotionalem Touch. Wir sind österreichischer Gesamtanbieter von Lichtlösungen, die wir an unserem Entwicklungs- und Produktionsstandort in Weißkirchen/Wels erzeugen. Funktionale Qualitätsleuchten, die herausragende Technik und modernstes Design vereinen und von uns in maßgeschneiderten Beleuchtungskonzepten wirkungsvoll kombiniert werden. Wir erschaffen positive Atmosphäre im Raum und machen Licht zu einem angenehmen Erlebnis.

Our lighting solutions for rooms with an emotional touch. We are an Austrian supplier of lighting solutions that we create at our development and production site in Weißkirchen/Wels. High-quality functional lighting that brings together outstanding technology and state-of-the-art design and which we can effectively combined in customised lighting concepts.. We create a positive atmosphere in the room and make lighting an enjoyable experience.

GOOD
EMOTIONS

GOOD
LIGHT
STORIES

Lösung ist nicht gleich Lösung. Das wissen wir genau, denn Molto Luce sammelt schon seit mehr als 40 Jahren umfassendes Know-how, das in all den individuell beleuchteten Projekten gezielt zum Einsatz kommt. Uns begeistern die vielen Möglichkeiten, die professionelle Beleuchtung mit sich bringt, unabhängig in welchem Anwendungsbereich:

Not all solutions are equal. We know that for a fact because Molto Luce has been gathering extensive know-how for more than 40 years, which is put specifically to use in every individual lighting project. We delight in the wealth of opportunities that professional lighting brings, no matter the area of application:



Shop und Retail
Shop and Retail



Büro und Firmenarchitektur
Office and Corporate Architecture



Industrie und Gewerbe
Industry and Trade



Öffentliche Gebäude
Public Buildings



Privates Wohnen und Hospitality
Private Living and Hospitality



Gesundheit und Pflege
Health and Care

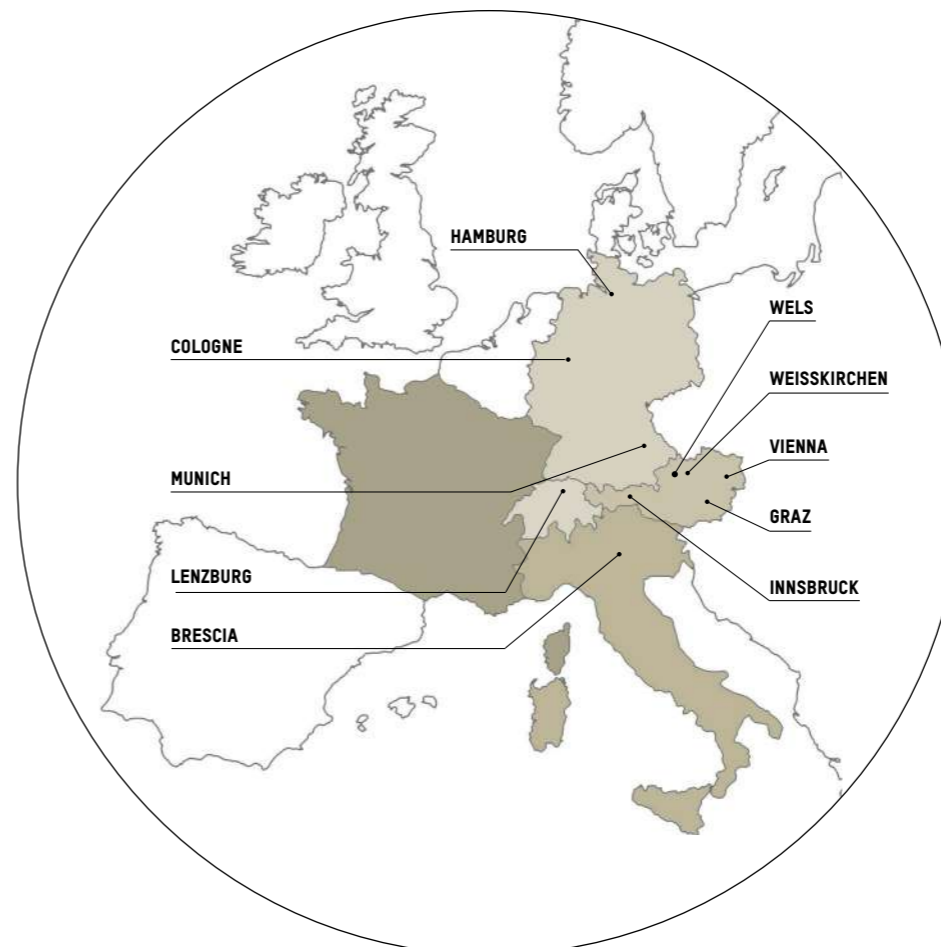

Im Zentrum unserer Entwicklungsprozesse steht somit ein Bündel von Aspekten. Im fertigen Produkt vereint sich smartes Design mit Funktionalität und Effizienz. Ergänzt um den wesentlichen Aspekt der Nachhaltigkeit und einer, auf die menschlichen Bedürfnisse abgestimmten, emotionalen Wirkung erfüllt Licht somit weit mehr als eine Funktion.

Am Ende entstehen Räume mit echtem, spürbarem Mehrwert.

A number of aspects therefore take centre stage in our development processes. Smart design meets functionality and efficiency in the finished product. Add in the key aspect of sustainability and an emotional impact tailored to human needs and light does so much more than fulfil a function.

The end result is rooms with real, perceptible added value.

Wir verstehen das Licht und achten auf Menschen und Umwelt. Als Produzent und erfahrener Projektpartner im Bereich von Highquality-Beleuchtungslösungen sind wir über den gesamten Leistungsprozess hinweg zu 100% in das Erschaffen von gutem Licht involviert.

We understand light and consider people and the environment. As a manufacturer and experienced project partner in the field of high-quality lighting solutions, we are 100% involved in creating good light throughout the entire service process.

Unser Input für eine stimmige Lichtatmosphäre durchläuft viele Touch-Points: beginnend beim Designprozess der Beleuchtungskörper bis in die After-Sales-Phase hinein, wie z.B. einer professionellen Ausrichtung der Leuchten im Projekt vor Ort.

Our input into a harmonious lighting atmosphere covers multiple touch points: beginning with the design process for the lighting fixtures, right through to the after-sales phase, for example professional arrangement of the lights in the project on site.

Daraus ergeben sich viele Vorteile für unsere Partner, denn wir verstehen die Technik ebenso wie die Planung oder die Montage. Wir sind zuverlässiger Lieferant mit Handschlagqualität, auch bei internationalen Projekten.

This results in a multitude of benefits for our partners, because we understand the technology as well as planning or installation. We are a reliable supplier with integrity, including for international projects.



Wussten Sie, dass..

...etwa 96% der CO₂-Emissionen einer Leuchte während ihrer Nutzungsphase anfallen? Wir sehen es daher als unsere Aufgabe, äußerst effiziente und nachhaltige Lichtlösungen zu entwickeln. Mehr noch: Als Unternehmen übernehmen wir nicht nur Verantwortung für unsere Produkte und Lichtprojekte. Auch in jeder Phase unserer Prozesse verpflichten wir uns zu einem fairen Miteinander und beachten den verantwortungsvollen Umgang mit den Ressourcen dieser Welt.

Did you know...

...around 96% of the CO₂ emissions from a light are produced during its service life? We therefore see it as our mission to develop extremely efficient and sustainable lighting solutions. And there's more: as a company, we take responsibility for more than just our products and lighting projects. We are also committed to a spirit of fairness in every phase of our processes and keep the responsible handling of our world's resources in mind.

Im People. Power. Planet. Programm von Molto Luce verschmelzen alle Aspekte zu einem transparenten Bild. Jede der drei Säulen hat klar definierte Ziele, für deren Erreichung wir spezifische Maßnahmen entwickelt haben. Wir freuen uns kontinuierlich über die Erreichung gesetzter Meilensteine, stehen aber auch vor neuen Herausforderungen und Möglichkeiten, welchen wir offen entgegenblicken!

In the **People. Power. Planet.** programme from Molto Luce, all of the aspects come together in a transparent image. Each of the three pillars has clearly defined goals that we have developed specific measures to achieve. We are constantly delighted to achieve the milestones we have set, but at the same time are faced with new challenges and opportunities which we look at candidly!

Auf Molto Luce ist Verlass – we care.

Wir setzen auf lösungsorientiertes Handeln und die Entwicklung innovativer Produkte, während wir uns um das Wohl der Menschen und die Erhaltung unserer Umwelt kümmern.

You can rely on Molto Luce – we care.

We rely on solution-oriented action and development of innovative products, while we take care of the well-being of people and conservation of our environment.

DEVELOPMENT AND PRODUCTION IN AUSTRIA



KENNEN SIE SCHON UNSER GESAMTES SORTIMENT?

DO YOU ALREADY KNOW OUR ENTIRE SORTIMENT?



Produkte für Ihr daily Business
Products for your daily business



Industriebeleuchtung & technisches Licht
Industrial & technical lighting



und vieles mehr!
and much more!



Gesamte Auswahl auf moltoluce.com
Full selection on moltoluce.com



MOVA



Roberto Cavalli Store, Vienna, Austria, Photo: Joachim Rauch



ALI Šokoladinė, Vilnius, Lithuania, Photo: Norbert Tukaj



Solargis Park, Bratislava, Slovakia, Photo: www.thomasmanina.com



Work Experience Space, Cologne, Germany, Photo: Project Rheinland AG



Moxy Hotel & Residence Inn, Den Haag, Netherland, Kitzig Design Studios
Photo: Marvin Schwienheer



Hiltl Hosen Manufaktur GmbH, Sulzbach, Germany, Photo: Joachim Rauch

MOVA



Object Carpet GmbH / City of Visions
Denkendorf, Germany
Photo: Markus Guhl

MORE VARIATIONS. MORE FLEXIBILITY.

Zehn Millionen Möglichkeiten, Modernste Technik & Klares Design - unsere flexible Strahler-Plattform setzt Maßstäbe. Der frei konfigurierbare Strahler bringt Varianten-Vielfalt, höchste Flexibilität und maximale Nachhaltigkeit aus nur einem Strahlerkopf. Auf diese Weise kann MOVA perfekt an unterschiedliche Anforderungen angepasst werden, ohne das Erscheinungsbild der jeweiligen Architektur verändern zu müssen. Dies ermöglicht eine ressourcenschonendere Beleuchtungslösung. Verschiedenste Accessoires ermöglichen eine noch bessere Entblendung, sowie zusätzliche Lichtszenarien für Spezialanwendungen.



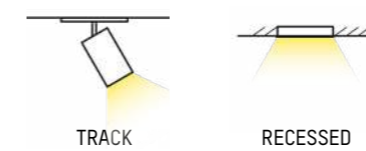

Ten million possibilities, state-of-the-art technology and clear design - our flexible spotlight platform creates a milestone. The freely configurable spotlight offers a wide variety, highest flexibility and maximum sustainability, all of which with only one spotlight head. This is how MOVA can be perfectly adapted to different requirements without changing the overall appearance of the architecture, resulting in a more resource-efficient illumination. Various accessories provide an even better glare control as well as additional light scenarios for special applications.

Design: INHOUSE

VARIATIONS

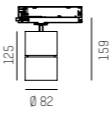

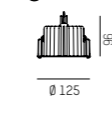
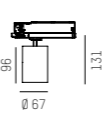
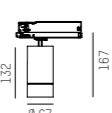
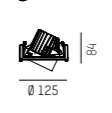
FORM & SIZES

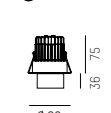
								
MOVA M track 14 - 40W 720 - 5630lm	MOVA M TURN recessed 12 - 37W 720 - 5630lm	MOVA M recessed 12 - 37W 720 - 5630lm	MOVA S track 8 - 20W 380 - 2240lm	MOVA S L track 8 - 20W 180 - 1730lm	MOVA S TURN recessed 8 - 17W 380 - 2240lm	MOVA S L TURN recessed 8 - 17W 180 - 1730lm	MOVA S recessed 8 - 17W 380 - 2240lm	MOVA S L recessed 8 - 17W 180 - 1730lm

CORE COLOURS

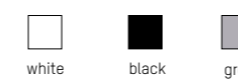

CREATIVE COLOURS

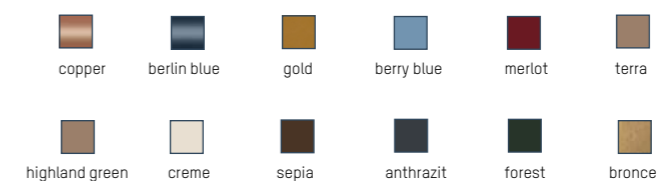

OPTICS



ACCESSOIRES



LED COLOURS



SPECIALS



SIMPLY ADVANTAGEOUS

Eine Reihe von Vorteilen sind mit der wechselbaren LED verbunden. Selbstverständlich denkt man in erster Linie an den Austausch defekter LEDs nach Ende ihrer Lebenszeit, doch dies hat bei den langen Zyklen eher untergeordnete Bedeutung.

**Einfacherer Generationenwechsel**

Hersteller von COBs bringen im Schnitt alle 2-3 Jahre eine neue Generation von Platinen auf den Markt. Damit verbunden sind deutliche Effizienzsteigerungen, da weniger Strom bei gleichzeitig mehr Lumenoutput verbraucht wird. Die Molto Luce X-Change Technology ermöglicht, rasch auf neue COB-Generationen umzusteigen und davon wirkungs- und kostenseitig zu profitieren.

**Unkomplizierte Adaption an sich ändernde Anforderungen**

Durch die Molto Luce X-Change-Technologie ist ein werkzeugloses Anpassen der Strahler an veränderte Beleuchtungsaufgaben möglich. Mit ein paar wenigen Handgriffen kann das COB-Modul oder auch der Reflektor getauscht werden. Eine andere Lichtfarbe oder CRI-Wert ist einfach, rasch und mit vergleichsweise geringen Kosten umgesetzt.

**Effizienzsteigerung und Kostenersparnis**

Der weiterentwickelte MOVA Strahler mit X-Change Technology konnte durch den größeren Reflektor und dessen innovativer Beschichtung in seiner Effizienz auf beachtliche 97% gesteigert werden. Die durch das neue System erzielte Flexibilität und Anpassungsmöglichkeit im Laufe der Lebenszeit des Strahlers bedeutet zudem einen massiven Einsparungseffekt, denn der Tausch der COB liegt bei rund 10% der Initialkosten, die ein Austausch eines kompletten Strahlers verursachen würde. Der Tausch amortisiert sich daher in wesentlich kürzerer Zeit.

**Nachhaltigkeit und Ressourcenschonung**

Weniger Materialverschwendung und Müll sowie geringere Transportaufwände sind mit einem reinen COB-Tausch zusätzlich gesichert. Das schützt unsere Umwelt. Zudem bringen die erzielten Effizienzsteigerungen durch niedrigere Leistungsaufnahme bei gleichem Lichtstromoutput, eine positivere Umweltbilanz mit sich.

**Dekorative Leuchten ein langlebiges Designobjekt**

Durch den einfachen COB-Tausch wird es in der Zukunft sicher auch für dekorative Leuchten möglich sein, die hochwertigen Leuchtenkörper deutlich länger als bis zum Lebensdauerende der LED im Einsatz zu haben. Wie von den GU10- oder E27-Fassungen bekannt, wird bei neuen Leuchten dann einfach nur das LED-Leuchtmittel getauscht. Geringe Kosten, umwelt-freundliches Verhalten.

A number of advantages are associated with the replaceable LED. Of course, one thinks primarily of replacing defective LEDs at the end of their service life, but this is of rather secondary importance given the long cycles.

Easier generation change

Manufacturers of COBs bring a new generation of PCBs onto the market every 2-3 years on average. This is associated with significant increases in efficiency, as less power is consumed with more lumen output at the same time. The Molto Luce X-Change Technology makes it possible to quickly switch to new COB generations and to benefit from this in terms of effect and costs.

Uncomplicated adaptation to changing requirements

Thanks to the Molto Luce X-Change technology, the spotlights can be adapted to changing lighting tasks without tools. The COB module or the reflector can be changed in a few simple steps. A different light colour or CRI value can be implemented easily, quickly and at a comparatively low cost.

Increased efficiency and cost savings

The efficiency of the further developed MOVA spotlight with X-Change Technology has been increased to a remarkable 97% thanks to the larger reflector and its innovative coating. The flexibility and adaptability achieved by the new system in the course of the spotlight's lifetime also mean a massive savings effect, because replacing the COB is around 10% of the initial costs that would be incurred by replacing a complete spotlight. The replacement, therefore, pays for itself in a much shorter time.

Sustainability and resource conservation

Less material wastage and waste as well as lower transport costs are additionally ensured with a pure COB exchange. This protects our environment. In addition, the efficiency increases achieved through lower power consumption with the same luminous flux output result in a more positive environmental balance.

Decorative luminaires a durable design object

Thanks to simple COB replacement, it will certainly also be possible in the future for decorative luminaires to have the high-quality luminaire bodies in use significantly longer than until the end of the LED's service life. As known from GU10 or E27 sockets, only the LED light source is replaced in new luminaires. Low costs, environmentally friendly behaviour.

Office Project, Kufstein, Austria
Photo: Joachim Rauch



more information

MOVA X-CHANGE

Die Weiterentwicklung des, primär im Retail-Sektor eingesetzten, Strahlers, bietet nun eine funktionale Lösung, um Anpassungen rasch und mit möglichst geringen Kosten vornehmen zu können. Der Wechsel der COB erfolgt mit Hilfe eines Bajonette-Verschlusses komplett werkzeuglos und kann auch direkt an der Stromschiene vorgenommen werden. Das COB-Modul gibt es mit einem Schutzglas für wirkungsvollen Staubschutz.

The further development of the spotlight, which is primarily used in the retail sector, now offers a functional solution to enable adjustments to be made quickly and at the lowest possible cost. The COB can be changed completely without tools using a bayonet lock and can also be carried out directly on the power rail. The COB module is available with protective glass for effective dust protection.

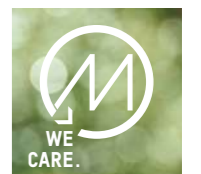



MOVA M TRACK

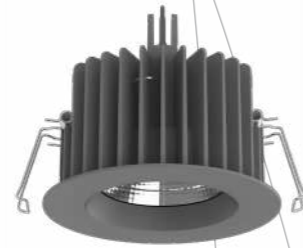

MOVA M R



MOVA M TURN R



MOVA S TRACK



MOVA S L TRACK



MOVA S R



MOVA S L R



MOVA S TURN R



MOVA S L TURN R



Core Colours.

Die Farben Schwarz, Weiß und Grau bestimmen unser Kernsortiment. The colours black, white and grey define our core range.



WEISS / WHITE



GRAU / GREY



SCHWARZ / BLACK



Creative Colours.

Ob Beerenblau, Merlot oder Hochlandgrün... unsere Creative Colours harmonieren perfekt mit unserem Produktsortiment und gleichzeitig auch mit den Farben der modernen Architektur.

Be it Berryblue, Merlot or Highlandgreen... our Creative Colours harmonise perfectly with our product range and simultaneously with the colours of modern architecture as well.



CREME / CREME



TERRA / TERRA



GOLD / GOLD



BRONZE / BRONZE



KUPFER / COPPER



MERLOT / MERLOT



BEERENBLAU / BERRYBLUE



BERLINERBLAU / BERLINBLUE



ANTHRAZIT / ANTHRACITE



HOCHLANDGRÜN / HIGHLANDGREEN



TANNENGRÜN / FOREST



SEPIA / SEPIA

INFO

Produkte in Creative Colour erhältlich Products available in Creative Colour

MOVA OVERVIEW

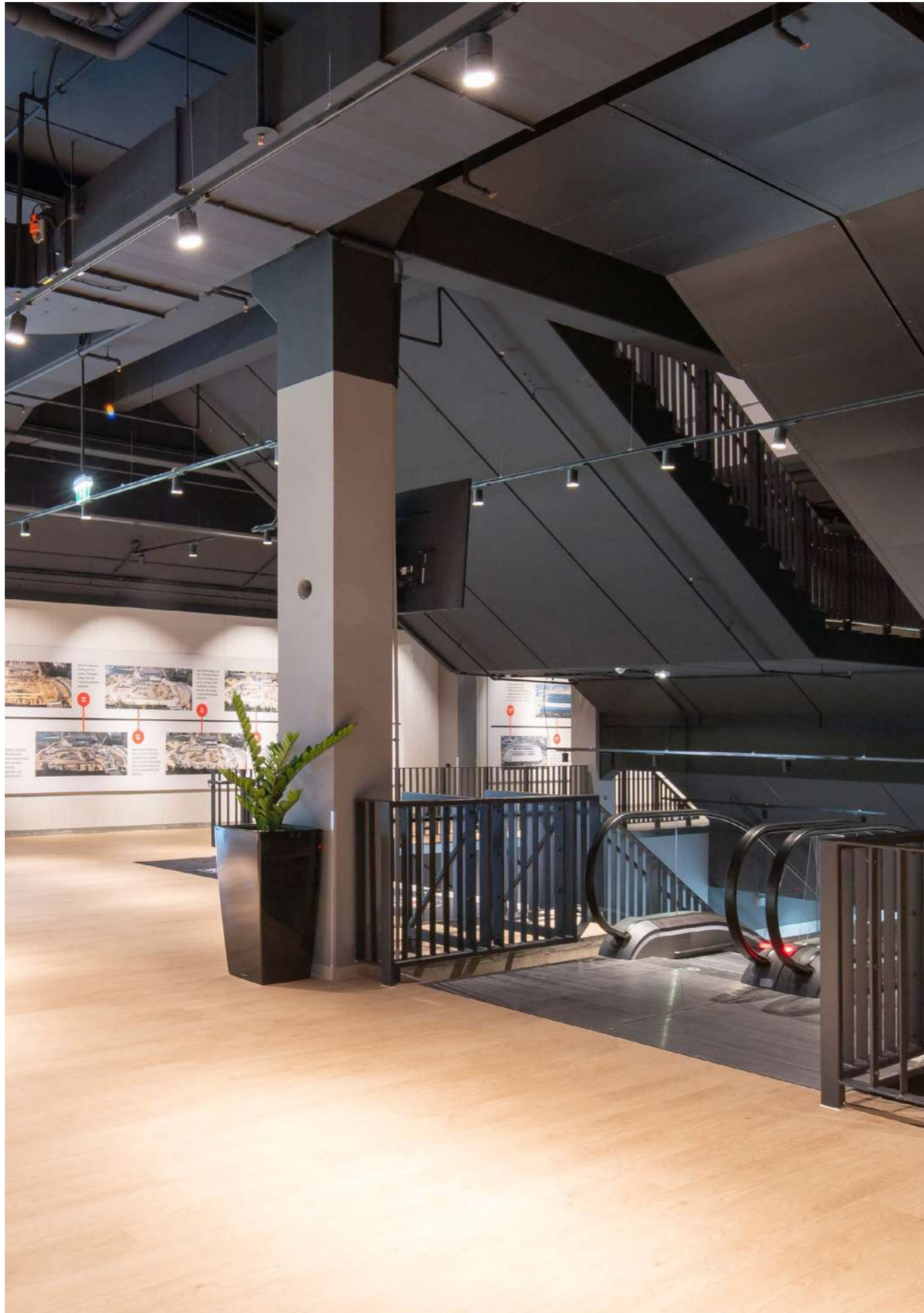

Raiffeisen Arena, Linz, Austria, Photo: Joachim Rauch

MOVA CONFIGURATOR

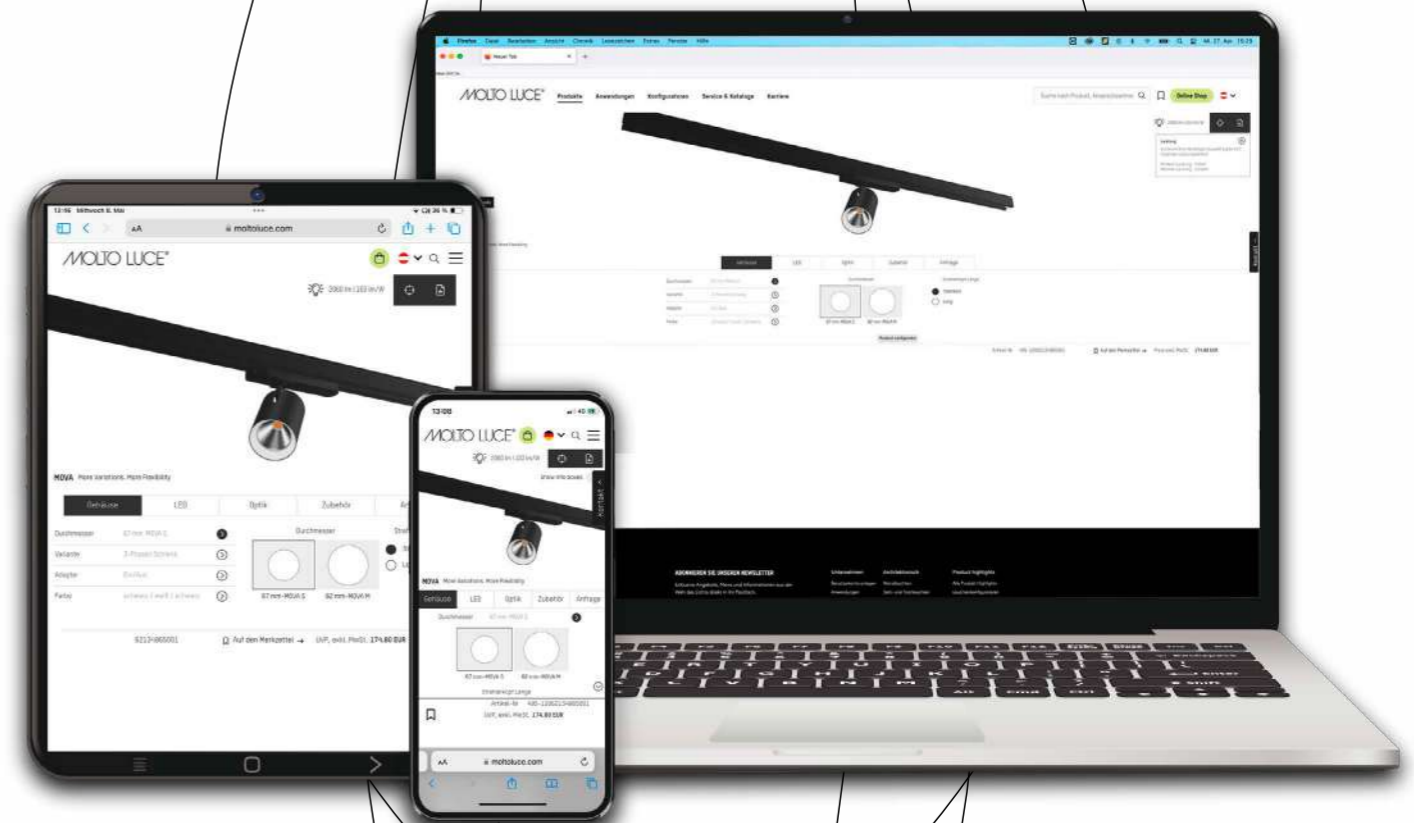
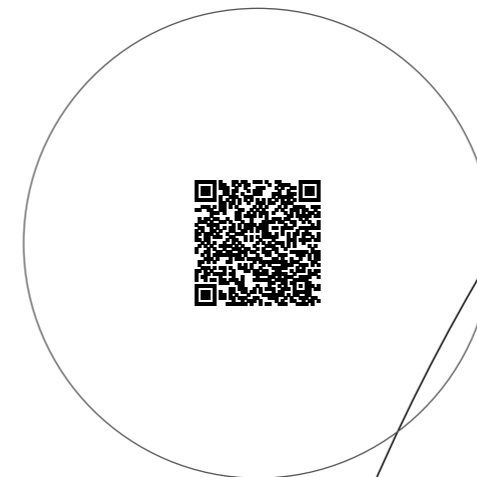

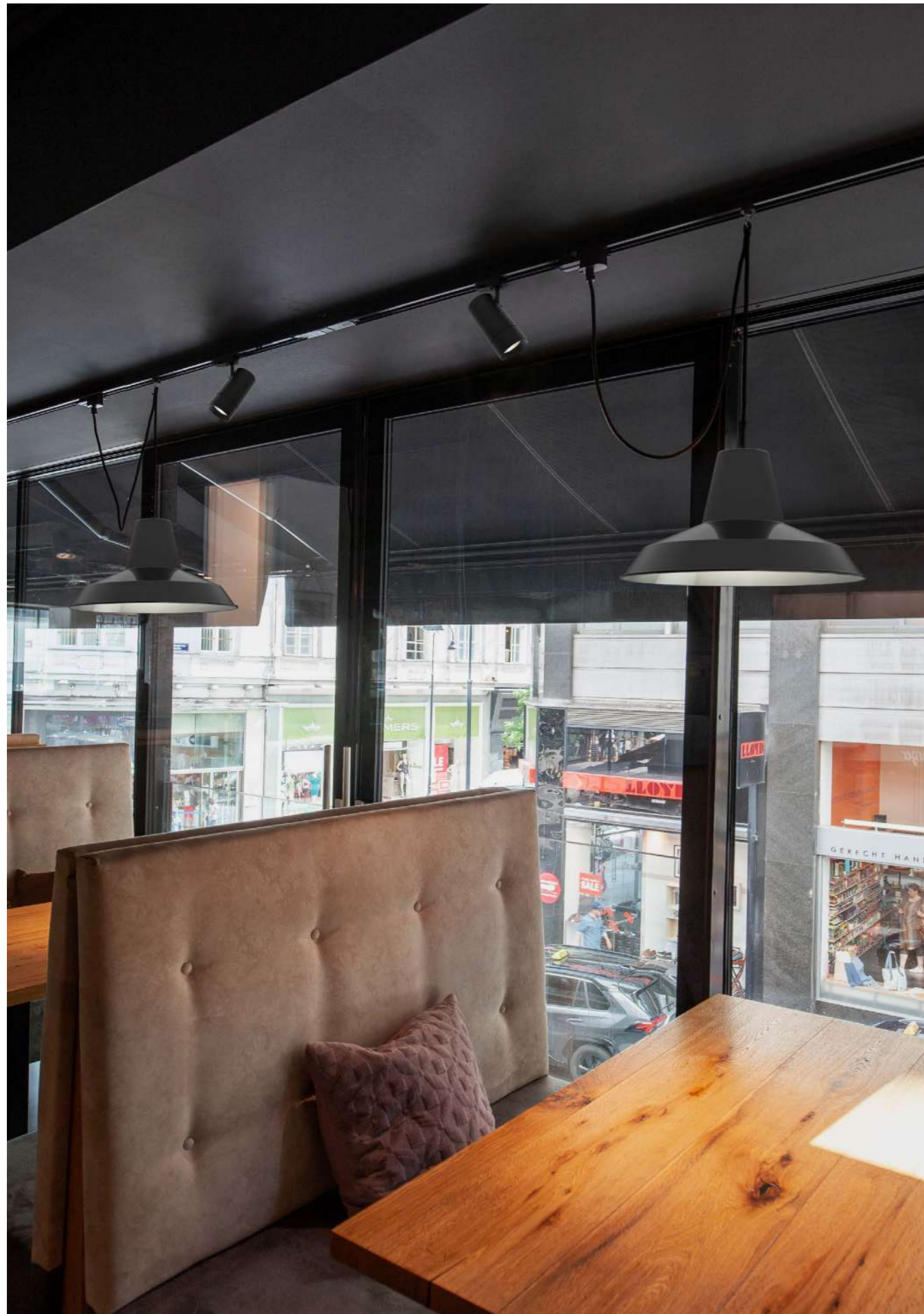

Restaurant Le Burger, Vienna, Austria, Photo: Joachim Rauch

MOVA S GU10

MOVA S GU10 TRACK

220-240V AC

50/60Hz

QPAR 16 / GU10 / Retrofit max. 9W

Design: INHOUSE

IP20

LED Schienenstrahler aus Aluminiumdruckguss · pulverbeschichtet · passend für LED Retrofit QPAR 16 · exkl. Leuchtmittel

LED track spotlight made of die-cast aluminium · powder-coated · suitable for LED retrofit QPAR 16 · without lamps

Proiettore LED in alluminio pressofuso · verniciata a polveri · compatibile con lampadine LED retrofit QPAR16 · lampadine escluse

Projecteur LED en aluminium moulé sous pression · thermolaqué · compatible avec les ampoules LED QPAR16 retrofit · sans ampoules

CODE

495-72000000XX0

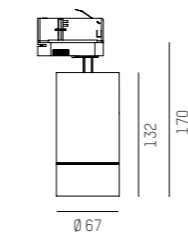

LEUCHTMITTEL 6W CRI>90

BULB 6W CRI>90

30-752517

30-707692

LICHTFARBE

COLOUR

2700K / 355lm

3000K / 375lm



COMPLETE CODE FOR ADAPTER

X = COLOUR

grey = 44	white = 55	black = 66
-----------	------------	------------



Kulturgarage, Vienna, Austria, Photo: Joachim Rauch

2 GO+ TRACK

2 GO+ TRACK

220-240V AC

50/60Hz

Design: INHOUSE







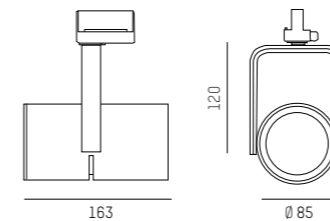



BLUETOOTH IP20 

LED Strahler aus Aluminiumdruckguss · Oberfläche pulverbeschichtet · Konverter im Strahlerkopf · steuerbar über Molto Luce Smart APP
 Die cast aluminium LED track spotlight · surface powder-coated · integrated Bluetooth LED Driver · controllable with Molto Luce Smart APP
 Faretto in alluminio pressofuso per binario · superficie verniciata a polveri · Bluetooth LED driver integrato · controllabile con Molto Luce Smart APP
 Spot sur rail en aluminium · surface thermolaquée · pilotage de LED par Bluetooth intégré · contrôlable avec système Molto Luce Smart APP

CODE	SYS W	LUMEN
637-00402RRWWXXbv2	27	2790 - 3190



COMPLETE CODE

RR = BEAM ANGLE	WW = LIGHT COLOUR	XX = COLOUR
 spot 17° = 01	 LED 2700K = 43 PREMIUM CRI>90	 grey = 04
 medium 24° = 02	 LED 3000K = 49 PREMIUM CRI>90	 white = 05
 flood 40° = 03	 LED 4000K = 24 CRI>90	 black = 06
 wide flood 60° = 04		
 asymmetric = 05		



Weingut Müller Vinothek, Klösch, Austria, Photo: Joachim Rauch

2 GO TRACK

2 GO TRACK

220-240V AC

50/60Hz

Design: INHOUSE

IP20

LED Stromschienenstrahler aus Aluminiumdruckguss · Oberfläche pulverbeschichtet · Konverter im Strahlerkopf DALI dimmbar oder schaltbar
 Die cast aluminium LED track spotlight · surface powder-coated · Integrated Dali dimmable or switchable
 Faretto in alluminio pressofuso per binario · superficie verniciata a polveri · convertitore on-off o dimmerabile DALI inclusoorizzontale
 Spot sur rail en aluminium · surface thermolaquée · convertiseur on-off ou dimmable DALI inclusconvertiseur

2 GO TRACK

CODE	SYS W	LUMEN
637-00101RRWWXX0v2	19	2080 - 2410
637-00102RRWWXXYv2	27	2760 - 3200

2 GO PRO TRACK

CODE	SYS W	LUMEN
637-00103RRWWXX0v2	26	2990 - 3650

Mit 24° und 40° Reflektor verfügbar
 Available with 24° and 40° reflector

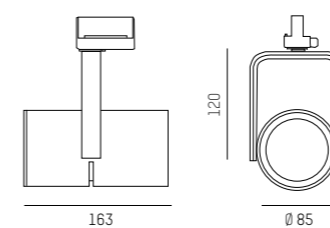

COMPLETE CODE

RR = BEAM ANGLE	WW = LIGHT COLOUR	XX = COLOUR	Y = DIMMABLE
spot 17° = 01	LED 2700K = 43 PREMIUM CRI>90	grey = 04	switchable = 0
medium 24° = 02	LED 3000K = 49 PREMIUM CRI>90	white = 05	PULSE DALI dim = p
flood 40° = 03	LED 4000K = 24 CRI>90	black = 06	
wide flood 60° = 04			
asymmetric = 05			

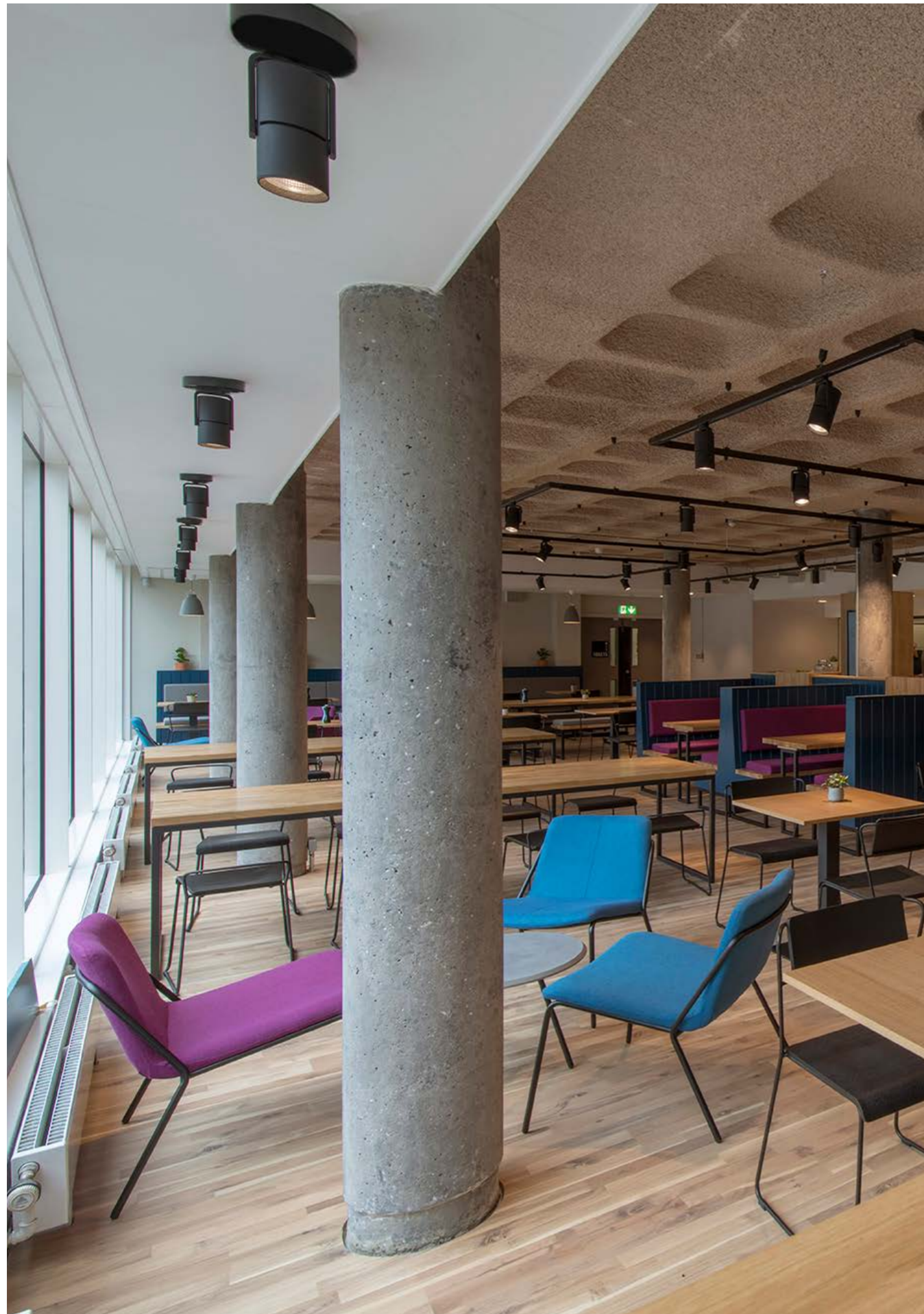

The Cafe Edinburgh, Scotland, Solus Solutions for lighting design, Project Architect: Lee Boyd

2 GO SD

2 GO SD

220-240V AC

50/60Hz









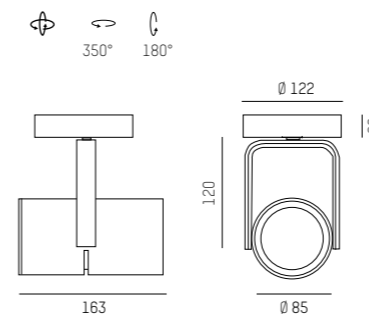



Design: INHOUSE

IP20 

LED Aufbaustrahler aus Aluminiumdruckguss · Oberfläche pulverbeschichtet · Konverter im Strahlerkopf DALI dimmbar oder schaltbar
 Die cast aluminium LED spotlight · surface powder-coated · Integrated Dali dimmable or switchable
 Faretto in alluminio pressofuso · superficie verniciata a polveri · converter on-off o dimmerabile DALI incluso
 Spot en aluminium · surface thermolaquée · convertiseur on-off ou dimmable DALI inclus convertiseur

CODE	SYS W	LUMEN
637-00501RRWWXX0v2	19	2120 - 2410
637-00502RRWWXXYv2	27	2760 - 3200



COMPLETE CODE			
RR = BEAM ANGLE	WW = LIGHT COLOUR	XX = COLOUR	Y = DIMMABLE
<ul style="list-style-type: none">  spot 17° = 01  medium 24° = 02  flood 40° = 03  wide flood 60° = 04  asymmetric = 05 	<ul style="list-style-type: none">  LED 2700K = 43 PREMIUM CRI>90  LED 3000K = 49 PREMIUM CRI>90  LED 4000K = 24 CRI>90 	<ul style="list-style-type: none">  grey = 04  white = 05  black = 06 	<ul style="list-style-type: none">  switchable = 0  DALI dim = d

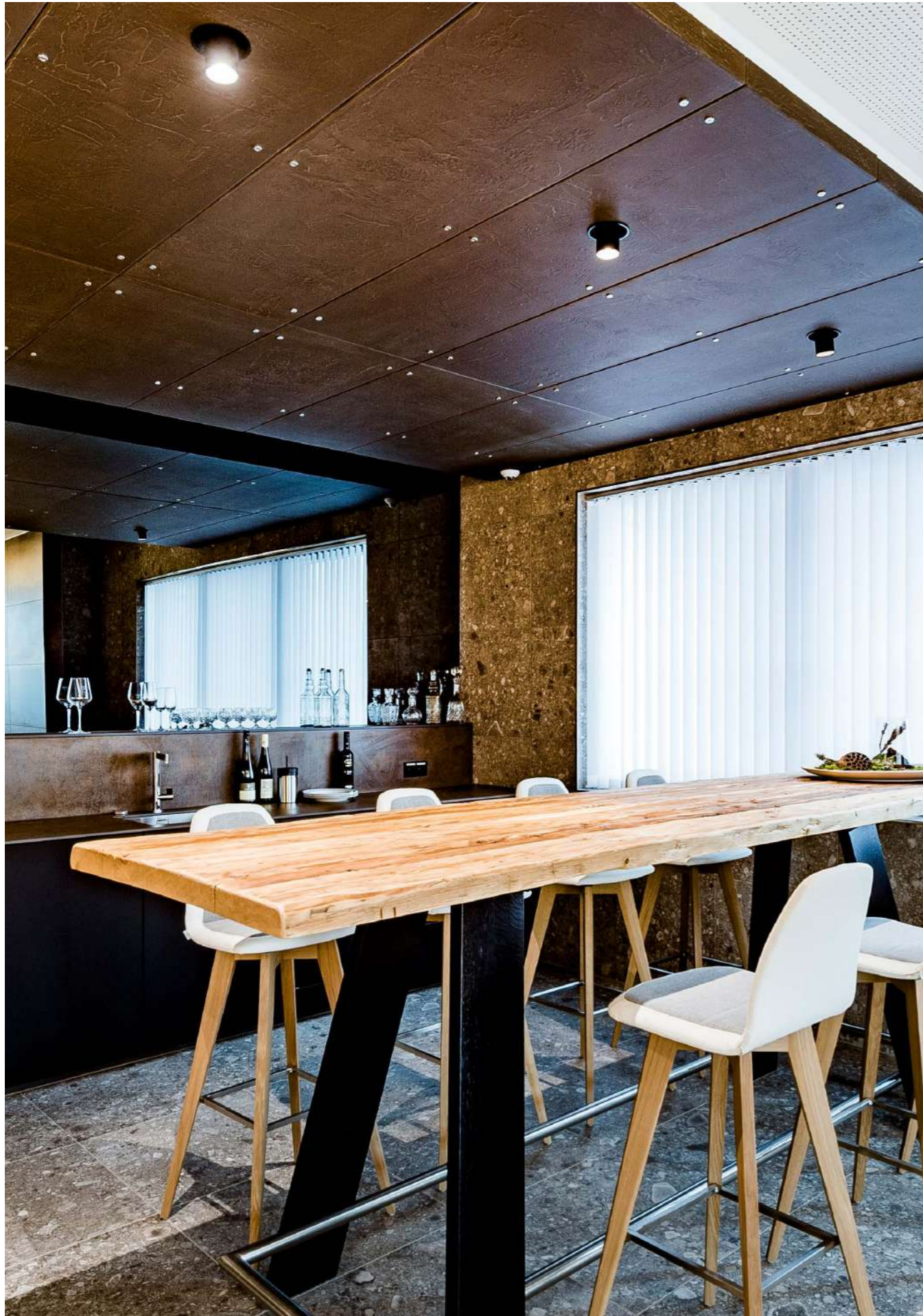

Kreisel & Electrics, Rainbach, Austria, Planning/realisation: Ben Elmecker, Photo: Kreisel Electric / Martin Pröll

2 GO R

2 GO R

220-240V AC

50/60Hz

Design: INHOUSE

IP20

LED Einbaustrahler · Oberfläche pulverbeschichtet · Strahler 350° drehbar, Leuchtenkopf 35° schwenkbar
Die cast aluminium LED spotlight · surface powder-coated · 350° swiveling and 35° tilting head
Incasso LED in alluminio · superficie verniciata a polveri · girevole a 350° e testa orientabile di 35°
Encassé à LED en aluminium · surface thermolaquée · pivotant à 350 et inclinaison de 35°

CODE	LED W / mA	LUMEN
637-00201RRWWXXv2	17 / 500	2150 - 2430
	25 / 700	2850 - 3240

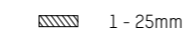
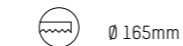
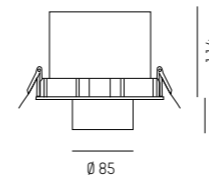

LED CONVERTER	mA	DIM	FOR
30-880006	500	not dimmable	2 GO R 17W
30-880206	700	not dimmable	2 GO R 25W
24-127490	500-700	DALI dimmable	2 GO R 17/25W
700-3004	500 - 700	CASAMBI dimmable	2 GO R 17/25W



COMPLETE CODE		
RR = BEAM ANGLE	WW = LIGHT COLOUR	XX = COLOUR
<ul style="list-style-type: none"> spot 17° = 01 medium 24° = 02 flood 40° = 03 wide flood 60° = 04 asymmetric = 05 	<ul style="list-style-type: none"> LED 2700K = 43 PREMIUM CRI>90 LED 3000K = 49 PREMIUM CRI>90 LED 4000K = 24 CRI>90 	<ul style="list-style-type: none"> grey = 04 white = 05 black = 06



DASH 2 TRACK

DASH 2 TRACK

220-240V AC

50/60Hz

Design: INHOUSE

IP20

Stromschienenstrahler aus Aluminium · Oberfläche pulverbeschichtet · Strahler 350° dreh-, 90° schwenkbar
 Track spotlight made of aluminium · powder-coated surface · spotlight 350° rotatable, 90° swivelling
 Faretto per binario in alluminio · superficie verniciata a polveri · testa girevole 350°, orientabile 90°
 Spot sur rail en aluminium · surface revêtue de poudre · tête orientable à 350°, pivotante à 90°

CODE	SYS W / AC	LUMEN
599-101010RWWXX0	10 AC	510 - 580

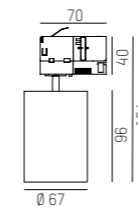

COMPLETE CODE

R = BEAM ANGLE

- spot 17° = 2
- medium 24° = 3
- flood 40° = 4

WW = LIGHT COLOUR

- LED 2700K = 23 CRI>90
- LED 3000K = 29 CRI>90
- LED 4000K = 24 CRI>90

XX = COLOUR

- grey = 04
- white = 05
- black = 06





DASH 2 SD

DASH 2 SD

220-240V AC

50/60Hz

Design: INHOUSE

IP20

Aufbaustrahler aus Aluminium · Oberfläche pulverbeschichtet · für Deckenmontage · Strahler 350° dreh-, 90° schwenkbar

Surface-mounted spotlight made of aluminium · powder-coated surface · for ceiling mounting · spotlight 350° rotatable, 90° swivelling

Proiettore a plafone in alluminio · superficie verniciata a polveri · per montaggio a soffitto · testa girevole 350°, orientabile 90°

Plafonnier en aluminium · surface revêtue de poudre · pour montage au plafond · tête orientable à 350°, pivotante à 90°

CODE	SYS W / AC	LUMEN
599-105010RWWXX0	10 AC	510 - 580

350° 90°

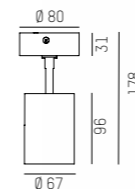

COMPLETE CODE

R = BEAM ANGLE	WW = LIGHT COLOUR	XX = COLOUR
spot 17° = 2	LED 2700K = 23 CRI>90	grey = 04
medium 24° = 3	LED 3000K = 29 CRI>90	white = 05
flood 40° = 4	LED 4000K = 24 CRI>90	black = 06





Raiffeisen Arena, Linz, Austria, Photo: Joachim Rauch

TRAIL TRACK

TRAIL TRACK

220-240V AC

50/60Hz

Design: INHOUSE

IP20

LED Schienenleuchte aus Aluminiumprofil · Oberfläche pulverbeschichtet oder eloxiert · mit Opal oder Mikroprismendiffusor erhältlich
 LED track luminaire from aluminium profile · surface powder-coated or anodized · available with opal or microprismatic diffuser
 Proiettore da binario in alluminio · superficie verniciata a polveri o anodizzata · diffusore opale o microprismatico
 Spot pour rail en profilé d'aluminium · surface lacquée en poudre ou anodisée · diffuseur opal ou microprismatique

CODE	SYS W	LUMEN
666-2001030RWWXXY	40	4790 - 6590

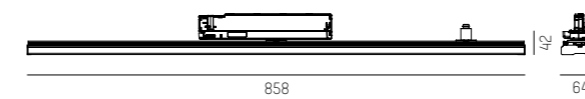

COMPLETE CODE			
R = BEAM ANGLE	WW = LIGHT COLOUR	XX = COLOUR	Y = DIMMABLE
wide = 1	LED 2700K = 13 CRI>80	grey = 04	switchable = 0
asymmetric = 2	LED 3000K = 19 CRI>80	white = 05	PULSE DALI dim = p
medium = 3	LED 4000K = 14 CRI>80	black = 06	BLUETOOTH dim = b
double sasymmetric = 4			CASAMBI dim = c



Carpe Diem, Linz, Austria, Photo: Joachim Rauch

VARIDO 2 TRACK

VARIDO 2 TRACK

220-240V AC

50/60Hz

Design: INHOUSE

IP20

Stromschienenleuchte aus Metall · Oberfläche pulverbeschichtet · Leuchte 350° drehbar
 Sheet metal LED track luminaire · surface powder coated · luminaire 350° swiveling
 Lampada da binario in metallo · superfice verniciata a polveri · Girevole a 350°
 Luminaire à rail métallique · surface revêtue de poudre · luminaire orientable à 350°

CODE	SYS W	LUMEN	BEAM
149-0020301 WWXXY	31	2940 - 3150	asymmetric
149-001RRRR WWXXY	32	3700 - 4770	66°

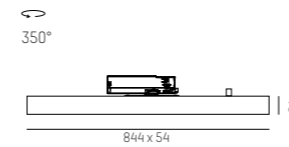

COMPLRTE CODE

RRRR = REFLECTOR	WW = LIGHT COLOUR	XX = COLOUR	Y = DIMMABLE
chrome - 66° beam = 0102 (UGR<19)	LED 2700K = 13 CRI>80	grey = 04	switchable = 0
dark chrome - 66° beam = 0202 (UGR<19)	LED 3000K = 19 CRI>80	white = 05	PULSE DALI dim = p
	LED 4000K = 14 CRI>80	black = 06	BLUETOOTH dim = b
			CASAMBI dim = c





ARTIS

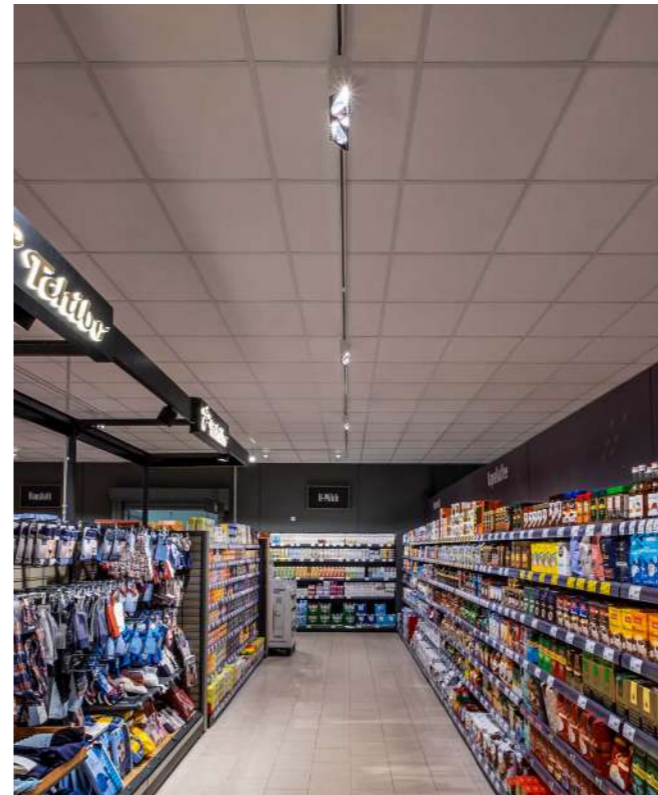

REWE, Troisdorf/Bergheim, Germany, Photo: Alexander Schwarz

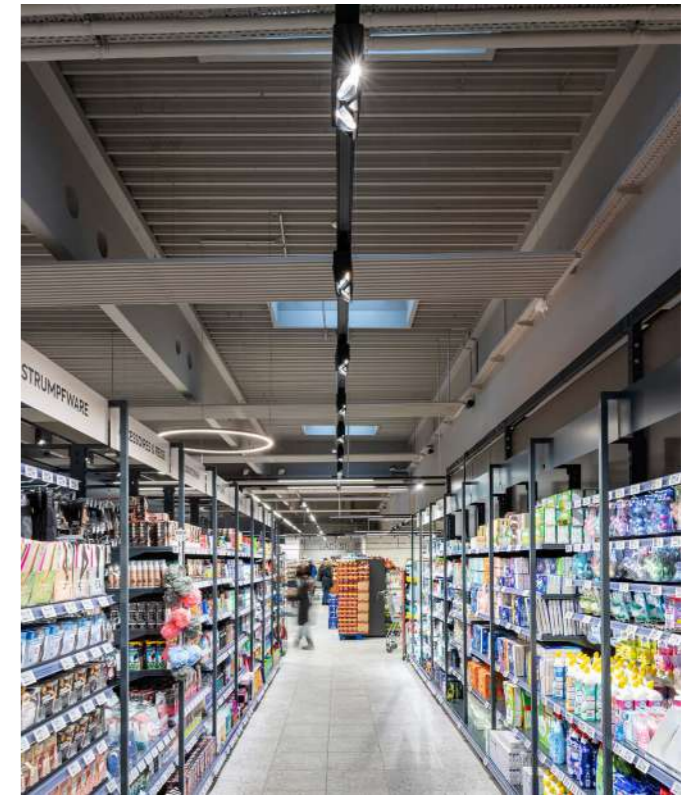

Billa Plus, Baden, Austria, Photo: Joachim Rauch

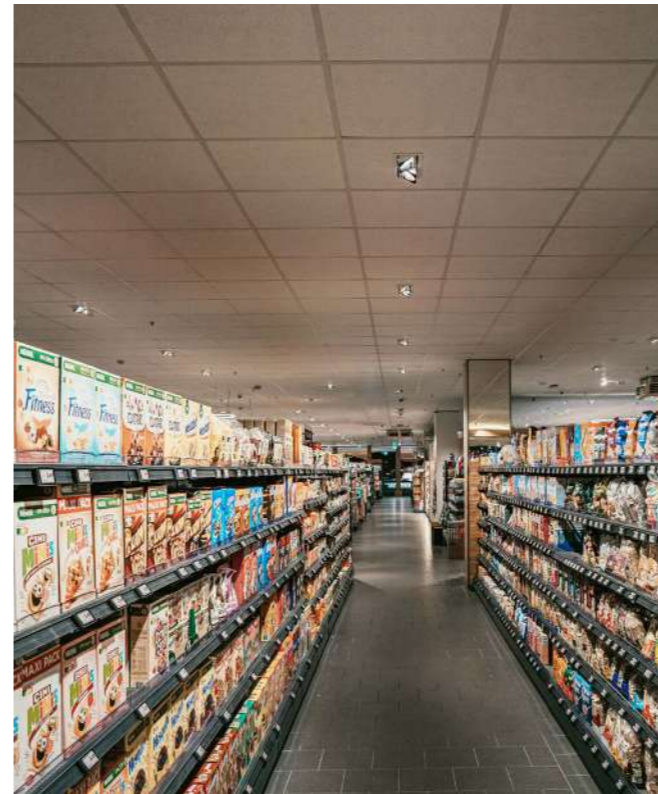

EDEKA, Bad Schwartau, Germany, Photo: Andrej Kleer

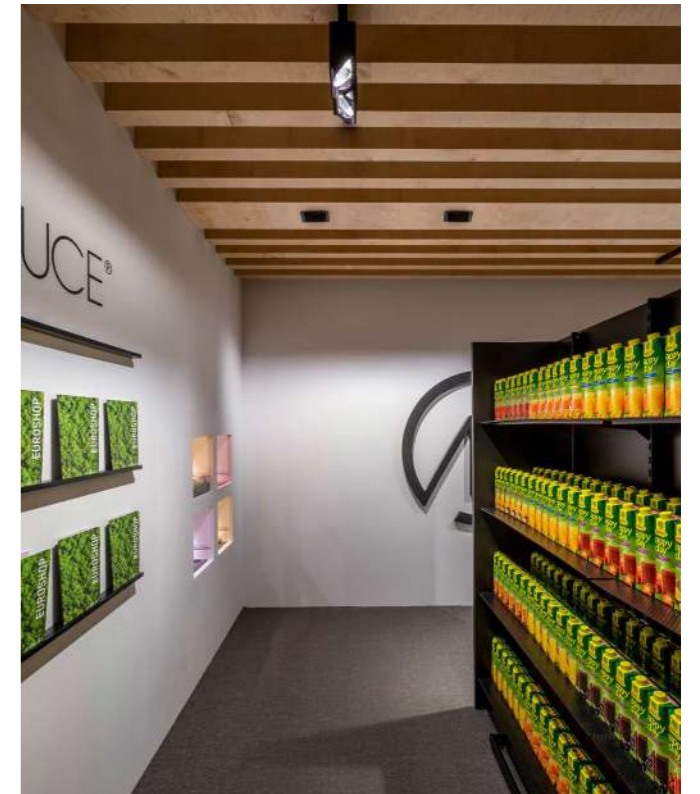

Euroshop Fair, Düsseldorf, Germany, Photo: Molto Luce

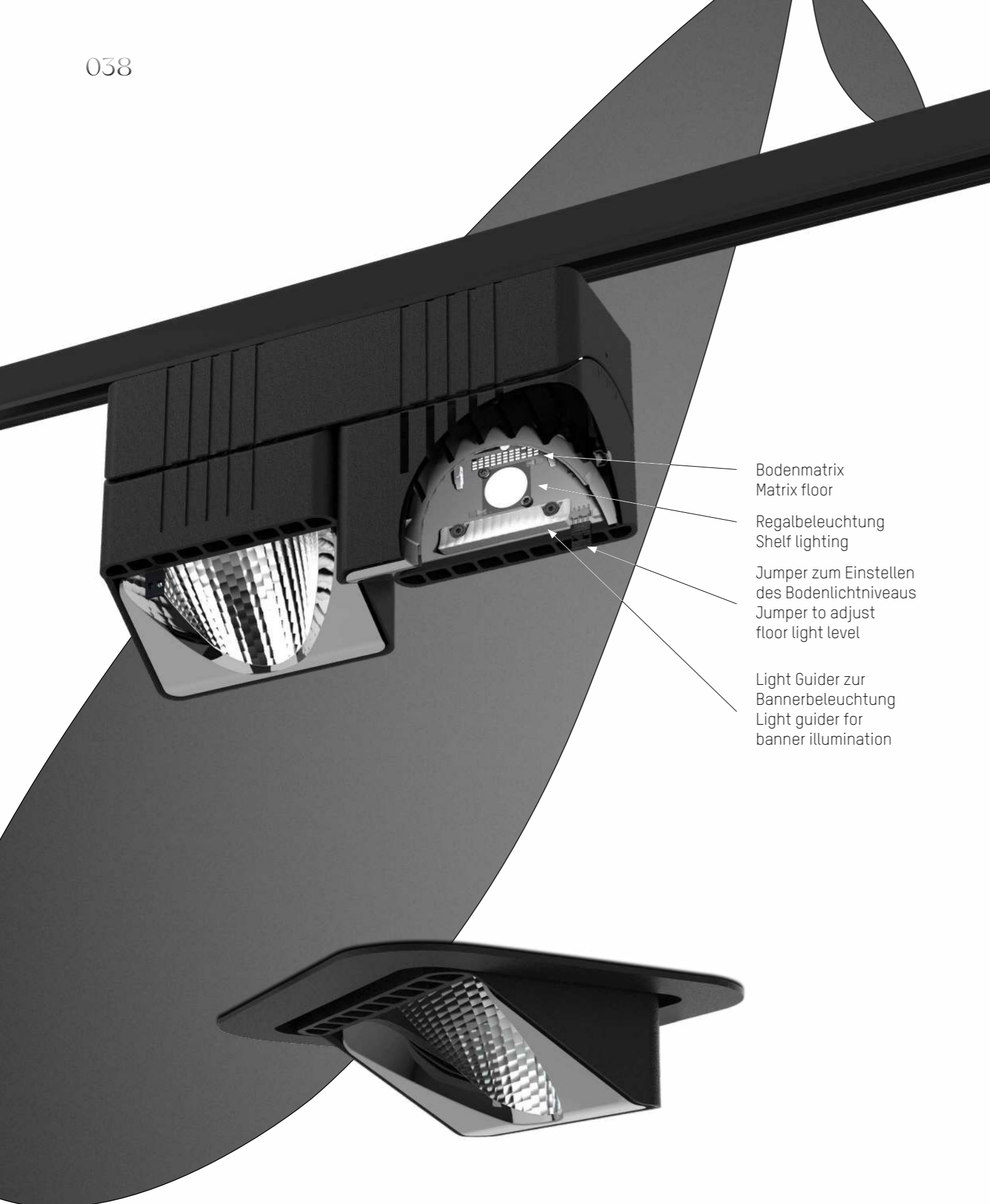

- Bodenmatrix
Matrix floor
- Regalbeleuchtung
Shelf lighting
- Jumper zum Einstellen
des Bodenlichtniveaus
Jumper to adjust
floor light level
- Light Guider zur
Bannerbeleuchtung
Light guider for
banner illumination

ARTIS

PERFECT LIGHTING TECHNOLOGY FOR RETAIL

ARTIS ist als 3-Phasen Stromschienenstrahler oder Einbaustrahler in 1-flammig asymmetrisch und 2-flammig doppelasymmetrisch sowie als Gondelkopfversion erhältlich. Der eigens konstruierte Freiformflächenreflektor mit Facettierung kombiniert maximale Effizienz mit bestmöglicher Längsentblendung bei einer absolut homogenen Ausleuchtung der zur beleuchtenden Fläche. Zudem kann Artis auch in den Sonderlichtfarben Magic Colour, Magic White, Meat & Fish, Fruits & Vegetables, Bread sowie 3500K Premium CRI>90 bestellt werden. Artis Matrix bietet eine absolute Innovation, welche erstmals das Anpassen der Abstrahlcharakteristik Vorort möglich macht. Für mehr Licht am Boden stellen sie einfach am Strahler die benötigte Helligkeit ein. Mit dem separat erhältlichem Light Guider verfügen Sie zudem über eine Bannerbeleuchtung in der dritten Ebene.

Artis is available as a 3-phase track spotlight or recessed spotlight with 1 light asymmetrical and with 2 lights double asymmetrical as well as single shelf version in black and white. The specially designed free-form surface reflector with faceting combines maximum efficiency with the best possible longitudinal glare control for absolutely homogeneous lighting of the surface to be illuminated. Artis can also be ordered in the special light colours Magic Colour, Magic White, Meat & Fish, Fruits & Vegetables, Bread and 3500K Premium CRI>90. Artis Matrix offers an absolute innovation, which for the first time makes it possible to adapt the beamangle on-site. If you would like more light on the floor just set the required brightness on the spotlight. With the separately available Light Guider banner on the 3rd level can also be illuminated.

Design: INHOUSE

VARIATIONS

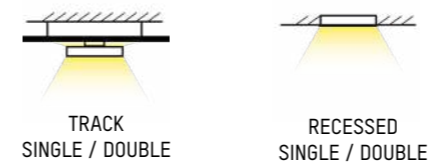

CORE COLOURS



white black

LED COLOURS



2700K 3000K 4000K

LIGHT BEAM



asymmetric double asymmetric

Artis Matrix - Der erste Strahler bei dem das Lichtbild Vorort elektronisch beeinflusst und adaptiert werden kann. Selbst nach der Montage kann die Abstrahlcharakteristik auf einfachste Weise direkt am Strahler angepasst werden.

Artis Matrix - The first spotlight in which the light pattern can be electronically influenced and adapted on site. Even after mounting, the radiation characteristics can be easily adjusted directly on the spotlight.

Artis Shelf Strahler wird im Shop verwendet, um Produkte in Stirnseiten von Regalen perfekt in Szene zu setzen.

Artis Shelf spotlights are used in shops to show perfectly products in the front of shelves.

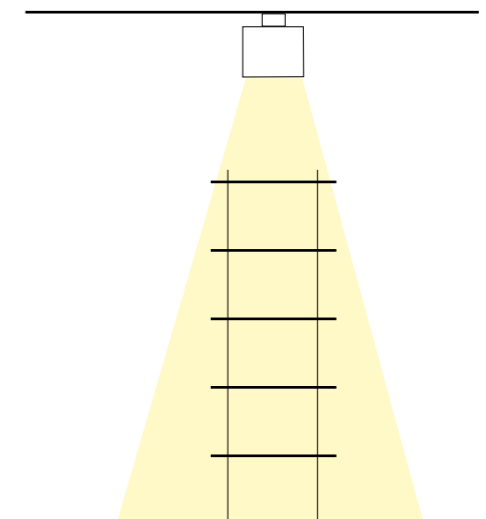
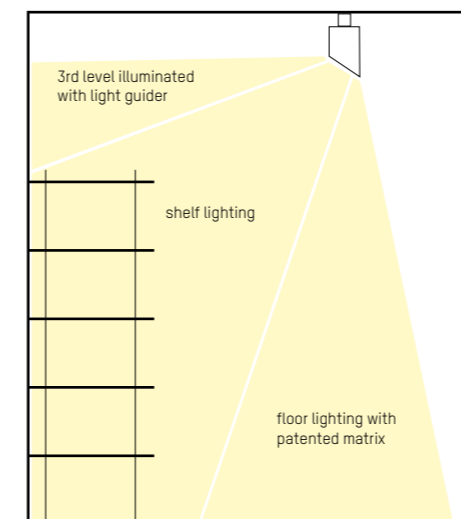



REWE, Troisdorf/Bergheim, Germany, Photo: Alexander Schwarz

ARTIS TRACK

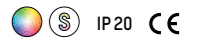



ARTIS TRACK

220-240V AC 50/60Hz Design: INHOUSE

Stromschienenstrahler mit Wallwasheroptik · Oberfläche Feinstrukturlack · vakuumbedampfter +/- 15° schwenkbarer Reflektor
 Track spotlight with wallwasher optics · surface microstructure painting · vacuum deposited reflector +/- 15° swiveling
 Proiettore da binario con ottica wallwasher · superficie verniciata a struttura fine · riflettore purissimo sottovuoto +/- 15° orientabile
 Projecteur pour rail avec optique wallwasher · surface fine texture peinte · réflecteur à vide pur +/- 15° réglable



ARTIS 1 TRACK

CODE		SYS W	LUMEN
704-1110101WWXXYv1		40	4090 - 4990

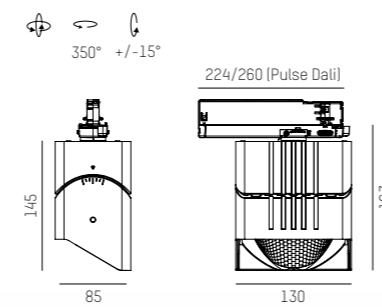
Asymmetrisch / Asymmetrical



ARTIS 2 TRACK

CODE		SYS W	LUMEN
704-1120102WWXXYv1		80	8180 - 9980



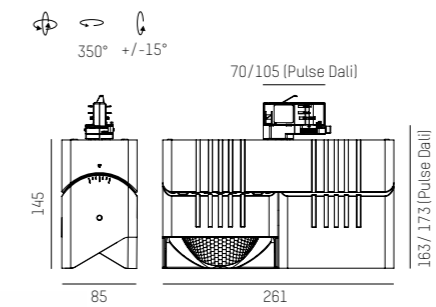



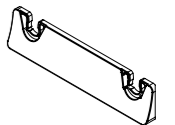

Doppelasymmetrisch / Doublesymmetrical



LIGHT GUIDER

704-9000310
 Zusätzlicher Reflektor zur Bannerbeleuchtung in der 3. Ebene
 Additional reflector to illuminate banners in the 3rd level



COMPLETE CODE		
WW = LIGHT COLOUR	XX = COLOUR	Y = DIMMABLE
 LED 2700K = 43 PREMIUM CRI>90	 white = 05	 switchable = 0
 LED 3000K = 49 PREMIUM CRI>90	 black = 06	 PULSE DALI dim = p
 LED 4000K = 24 CRI>90		 SMART BLUETOOTH dim = b

ARTIS MATRIX TRACK

ARTIS MATRIX FLOOR TRACK

220-240V AC 50/60Hz Design: INHOUSE



Stromschienenstrahler mit Wallwasheroptik · Oberfläche Feinstrukturlack · vakuumbedampfter +/- 15° schwenkbarer Reflektor
 Track spotlight with wallwasher optics · surface microstructure painting · vacuum deposited reflector +/- 15° swiveling
 Proiettore da binario con ottica wallwasher · superficie verniciata a struttura fine · riflettore purissimo sottovuoto +/- 15° orientabile
 Projecteur pour rail avec optique wallwasher · surface fine texture peinte · réflecteur à vide pur +/- 15° réglable

ARTIS 1 MATRIX FLOOR TRACK

CODE	SYS W	LUMEN
704-1110301WWXXYv1	40	4090 - 4990

Asymmetrisch / Asymmetrical

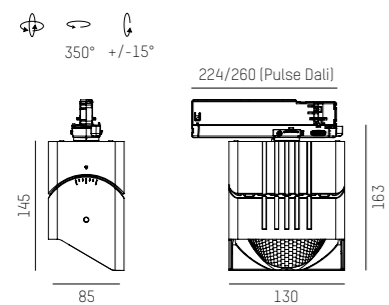

ARTIS 2 MATRIX FLOOR TRACK

CODE	SYS W	LUMEN
704-1120302WWXXYv1	80	8180 - 9980

Doppelasymmetrisch / Doubleasymmetrical

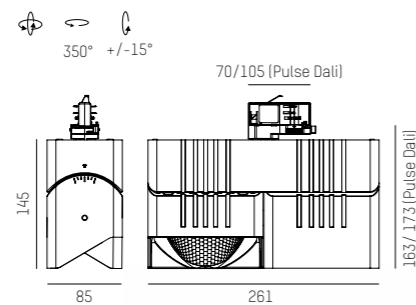

LIGHT GUIDER

704-9000310

Zusätzlicher Reflektor zur Bannerbeleuchtung in der 3. Ebene

Additional reflector to illuminate banners in the 3rd level



COMPLETE CODE		
WW = LIGHT COLOUR	XX = COLOUR	Y = DIMMABLE
W2 LED 2700K = 43 PREMIUM CRI>90	W white = 05	S switchable = 0
W3 LED 3000K = 49 PREMIUM CRI>90	S black = 06	P PULSE DALI dim = p
W4 LED 4000K = 24 CRI>90		B SMART BLUETOOTH dim = b

PRODUCTS

ARTIS SHELF TRACK

ARTIS SINGLE SHELF TRACK

220-240V AC 50/60Hz Design: INHOUSE



Stromschienenstrahler mit Wallwasheroptik · Oberfläche Feinstrukturlack · vakuumbedampfter +/- 15° schwenkbarer Reflektor
 Track spotlight with wallwasher optics · surface microstructure painting · vacuum deposited reflector +/- 15° swiveling
 Proiettore da binario con ottica wallwasher · superficie verniciata a struttura fine · riflettore purissimo sottovuoto +/- 15° orientabile
 Projecteur pour rail avec optique wallwasher · surface fine texture peinte · réflecteur à vide pur +/- 15° réglable

ARTIS 1 SINGLE SHELF TRACK

CODE	SYS W	LUMEN
704-1111101WWXXYv1	40	3740 - 4560

Asymmetrisch / Asymmetrical

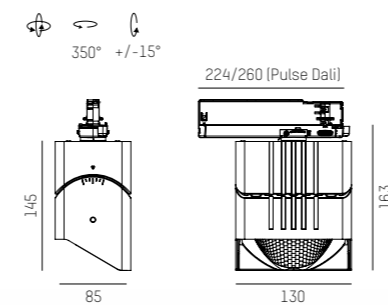

ARTIS 2 SINGLE SHELF TRACK

CODE	SYS W	LUMEN
704-1121102WWXXYv1	80	7490 - 9130

Doppelasymmetrisch / Doubleasymmetrical

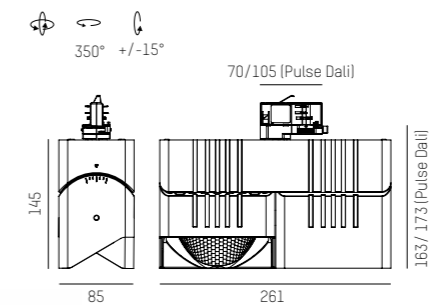

LIGHT GUIDER

704-9000310

Zusätzlicher Reflektor zur Bannerbeleuchtung in der 3. Ebene

Additional reflector to illuminate banners in the 3rd level

To luminaire the head of the shelf

ARTIS Single Shelf

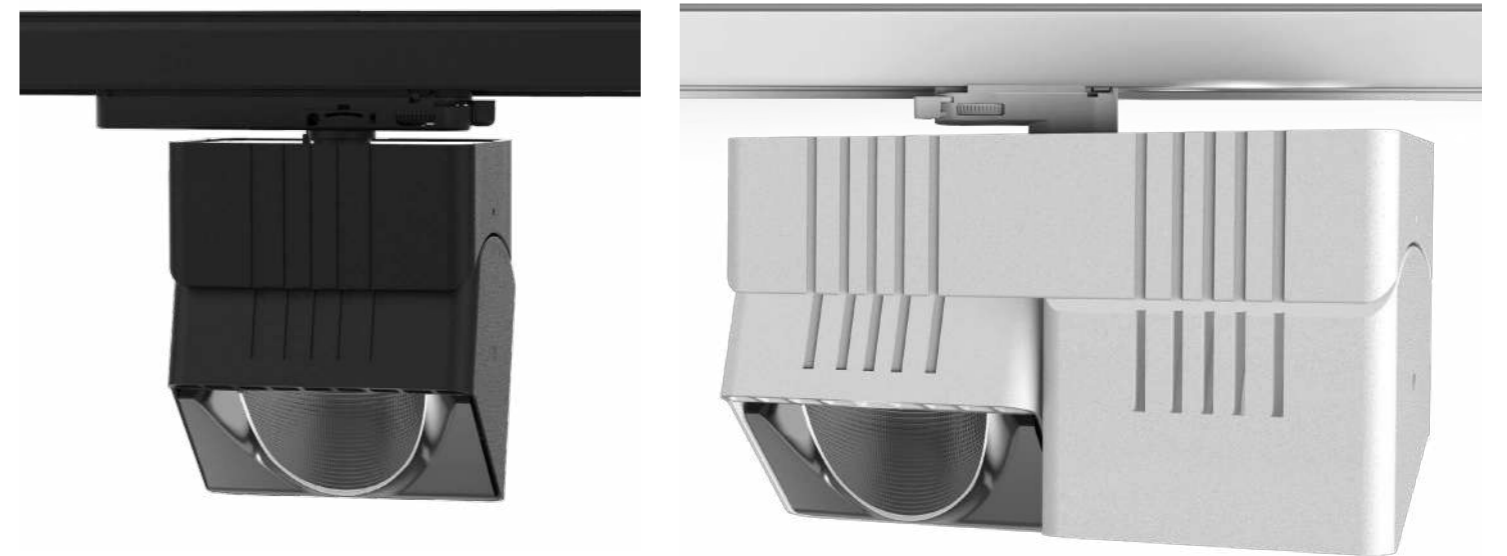

COMPLETE CODE		
WW = LIGHT COLOUR	XX = COLOUR	Y = DIMMABLE
W2 LED 2700K = 43 PREMIUM CRI>90	W white = 05	S switchable = 0
W3 LED 3000K = 49 PREMIUM CRI>90	S black = 06	P PULSE DALI dim = p
W4 LED 4000K = 24 CRI>90		B SMART BLUETOOTH dim = b

PRODUCTS



Euroshop Fair, Düsseldorf, Germany, Photo: Molto Luce

ARTIS R

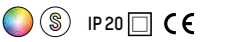

ARTIS R

220-240V AC 50/60Hz Design: INHOUSE

Einbaustrahler mit Wallwasheroptik · Oberfläche Feinstrukturlack · vakuumbedampfter +/- 15° schwenkbarer Reflektor
 Recessed spotlight with wallwasher optics · surface microstructure painting · vacuum deposited reflector +/- 15° swiveling
 Incasso con ottica wallwasher · superficie verniciata a struttura fine · riflettore purissimo sottovuoto +/- 15° orientabile
 Spot encastré avec optique wallwasher · surface fine texture peinte · réflecteur à vide pur +/- 15° réglable

ARTIS 1 R

CODE	LED W	LUMEN
704-2110101 WWXX0v1	40	4090 - 4990
1050mA		
Asymmetrisch / Asymmetrical		

+/- 15°

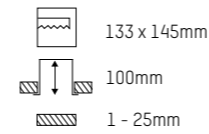
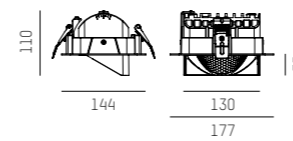

ARTIS 2 R

CODE	LED W	LUMEN
704-2120102 WWXX0v1	80	8180 - 9980
2 x 1050mA		
Doppelasymmetrisch / Doubleasymmetrical		

+/- 15°

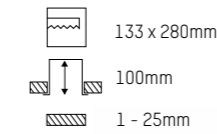
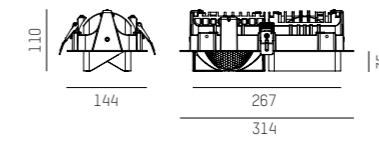

LIGHT GUIDER

704-9000310

Zusätzlicher Reflektor zur Bannerbeleuchtung in der 3. Ebene

Additional reflector to illuminate banners in the 3rd level

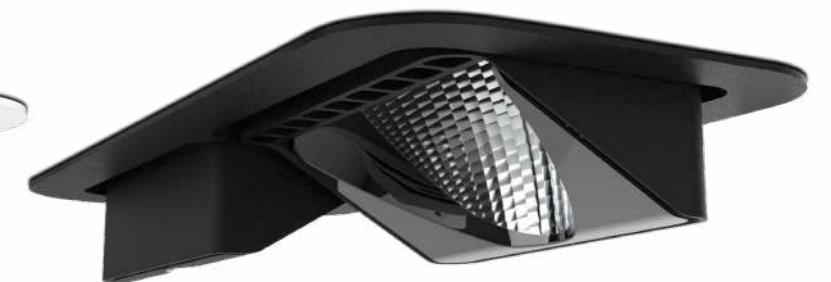
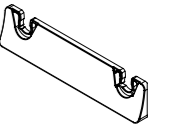

LED CONVERTER	DIM
24-127484	not dimmable
24-127490	driver Dali dim
701-1001	driver BLUETOOTH dim

LED CONVERTER	DIM
2x 24-127484	not dimmable
2x 24-127490	driver Dali dim
2x 701-1001	driver BLUETOOTH dim



COMPLETE CODE

WW = LIGHT COLOUR	XX = COLOUR
W2 LED 2700K = 43 PREMIUM CRI>90	W white = 05
W3 LED 3000K = 49 PREMIUM CRI>90	S black = 06
W4 LED 4000K = 24 CRI>90	

ARTIS MATRIX R

ARTIS MATRIX FLOOR R

220-240V AC 50/60Hz Design: INHOUSE

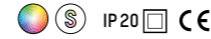

Einbastrahler mit Wallwasheroptik · Oberfläche Feinstrukturlack · vakuumbedampfter +/- 15° schwenkbarer Reflektor
 Recessed spotlight with wallwasher optics · surface microstructure painting · vacuum deposited reflector +/- 15° swiveling
 Incasso con ottica wallwasher · superficie verniciata a struttura fine · riflettore purissimo sottovuoto +/- 15° orientabile
 Spot encastré avec optique wallwasher · surface fine texture peinte · réflecteur à vide pur +/- 15° réglable

ARTIS 1 MATRIX FLOOR R

CODE	LED W	LUMEN
704-2110301 WWXX0v1	40	4090 - 4990
1050mA		
Asymmetrisch / Asymmetrical		

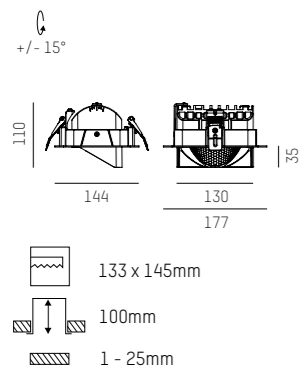

ARTIS 2 MATRIX FLOOR R

CODE	LED W	LUMEN
704-2120302 WWXX0v1	80	8180 - 9980
2 x 1050mA		
Doppelasymmetrisch / Doubleasymmetrical		

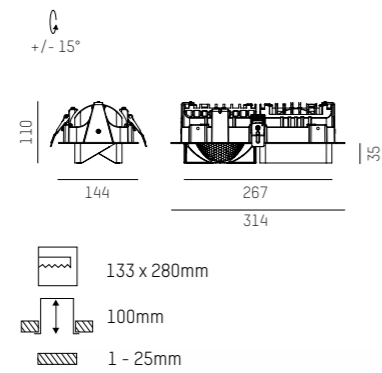

LIGHT GUIDER
704-9000310
 Zusätzlicher Reflektor zur Bannerbeleuchtung in der 3. Ebene
 Additional reflector to illuminate banners in the 3rd level

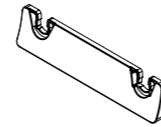

LED CONVERTER	DIM
24-127484	not dimmable
24-127490	driver Dali dim
701-1001	driver BLUETOOTH dim

LED CONVERTER	DIM
2x 24-127484	not dimmable
2x 24-127490	driver Dali dim
2x 701-1001	driver BLUETOOTH dim



COMPLETE CODE	
WW = LIGHT COLOUR	XX = COLOUR
W2 LED 2700K = 43 PREMIUM CRI>90	W white = 05
W3 LED 3000K = 49 PREMIUM CRI>90	S black = 06
W4 LED 4000K = 24 CRI>90	

ARTIS SHELF R

ARTIS SINGLE SHELF R

220-240V AC 50/60Hz Design: INHOUSE

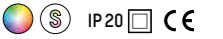

Einbastrahler mit Wallwasheroptik · Oberfläche Feinstrukturlack · vakuumbedampfter +/- 15° schwenkbarer Reflektor
 Recessed spotlight with wallwasher optics · surface microstructure painting · vacuum deposited reflector +/- 15° swiveling
 Incasso con ottica wallwasher · superficie verniciata a struttura fine · riflettore purissimo sottovuoto +/- 15° orientabile
 Spot encastré avec optique wallwasher · surface fine texture peinte · réflecteur à vide pur +/- 15° réglable

ARTIS 1 SINGLE SHELF R

CODE	LED W	LUMEN
704-2111101 WWXX0v1	40	3740 - 4560
1050mA		
Asymmetrisch / Asymmetrical		

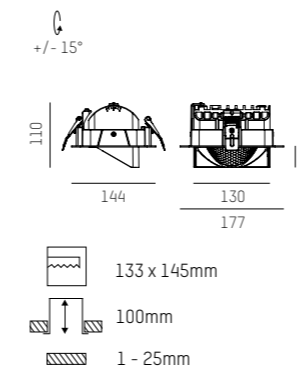

ARTIS 2 SINGLE SHELF R

CODE	LED W	LUMEN
704-2121102 WWXX0v1	80	7490 - 9130
2 x 1050mA		
Doppelasymmetrisch / Doubleasymmetrical		

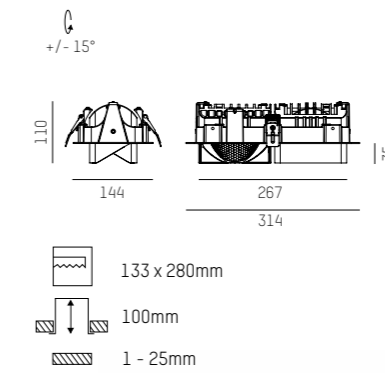

To luminaire the head of the shelf ARTIS Single Shelf



LED CONVERTER	DIM
24-127484	not dimmable
24-127490	driver Dali dim
701-1001	driver BLUETOOTH dim

LED CONVERTER	DIM
2x 24-127484	not dimmable
2x 24-127490	driver Dali dim
2x 701-1001	driver BLUETOOTH dim



COMPLETE CODE	
WW = LIGHT COLOUR	XX = COLOUR
W2 LED 2700K = 43 PREMIUM CRI>90	W white = 05
W3 LED 3000K = 49 PREMIUM CRI>90	S black = 06
W4 LED 4000K = 24 CRI>90	



TARIO

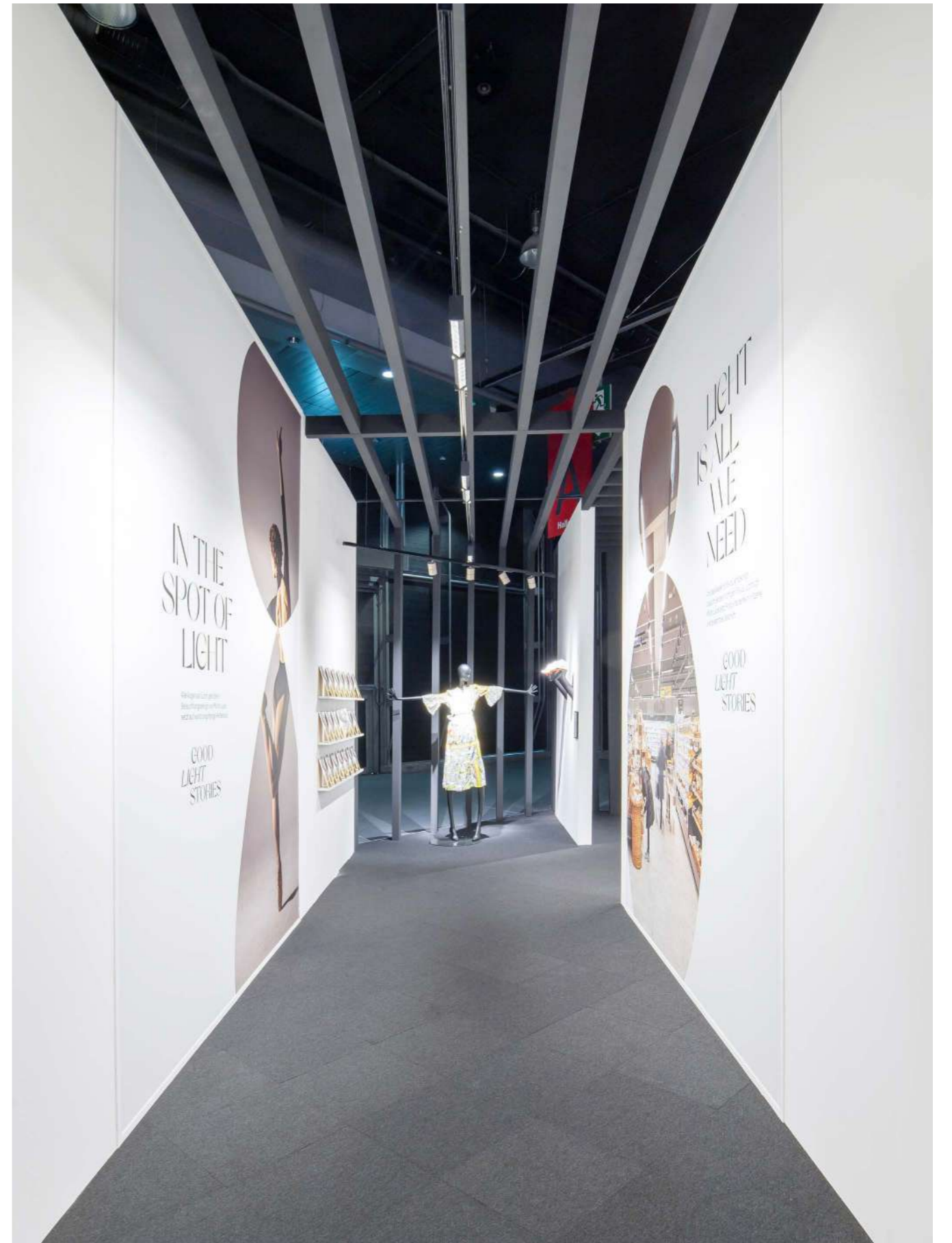

Light & Building, Frankfurt, Germany, Photo: Joachim Rauch

TARIO

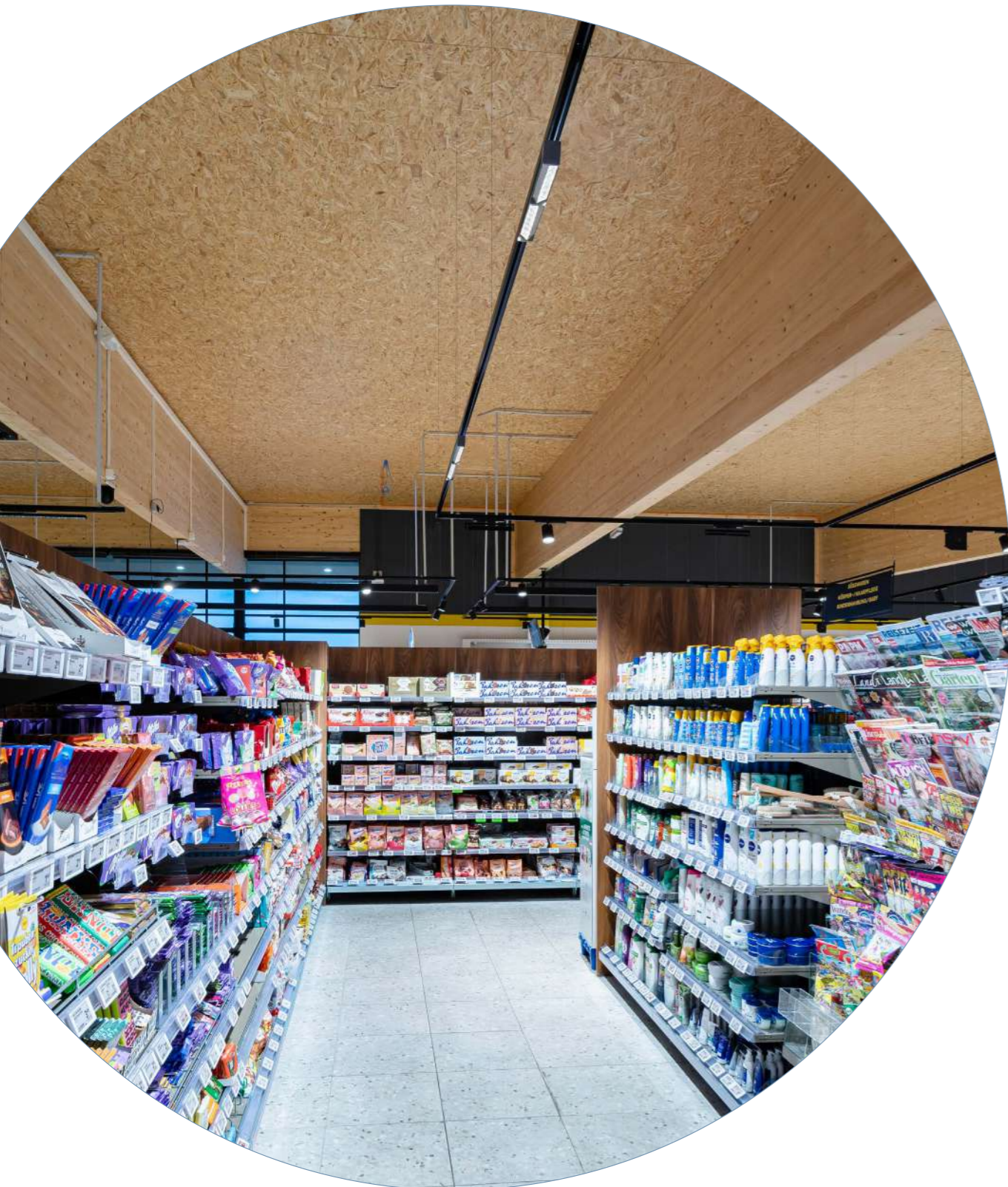

BRIGHT SPOT ON THE SHELF

Optimale Beleuchtung für jede Regalhöhe – eine Herausforderung und ein Problem, das TARIO löst. TARIO ist die revolutionäre Lösung der Shop-Beleuchtung. Der schlanke Leuchtenkörper passt sich elegant an die Form der Stromschiene an und „verschwindet“ nahezu an der Decke. Lineare Raster-Optiken führen zu einer perfekten Entblendung im Shop! Ob 1- oder 2-flammig, linear oder parallel ausgerichtet, der Gangzonenstrahler passt sich, als Einsatz für die 3-Phasen-Schiene, der Tragschiene TRAIL und als Einbau-Version, mühelos jeder erdenklichen Anforderung an. Die schwenkbare Konstruktion, ausgestattet mit einem Rastmechanismus, ermöglicht eine präzise Ausrichtung des Lichts auf verschiedene Ebenen und schafft damit eine dynamische Atmosphäre. Und werkzeuglos tauschbare Lichteinsätze runden das Gesamtpaket dieser Leuchtenserie ab – damit ist TARIO auch beim Thema der unkomplizierten Wartung die zuverlässige Wahl!

Optimal lighting for every shelf height – a challenge and a problem that TARIO solves. TARIO is the revolutionary solution for shop lighting. The slim luminaire body adapts elegantly to the shape of the tracks and virtually 'disappears' into the ceiling. Linear louvre optics lead to perfect glare control in the shop! Whether 1 or 2 light inserts, linear or parallel aligned, TARIO adapts effortlessly to every conceivable requirement, as an insert for the 3-phase tracks or TRAIL mounting rail, and as a recessed version. The swiveling design, equipped with a locking mechanism, allows precise alignment of the light on different levels, creating a dynamic atmosphere. And tool-free replaceable light inserts complete the overall package of this luminaire series – making TARIO also the reliable choice for easy maintenance!

Design: INHOUSE

VARIATIONS

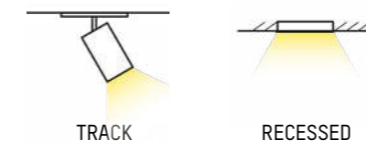

CORE COLOURS

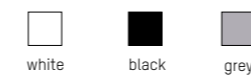

LED COLOURS

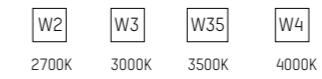

OPTICS

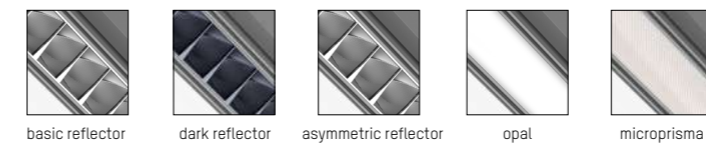

SPECIALS



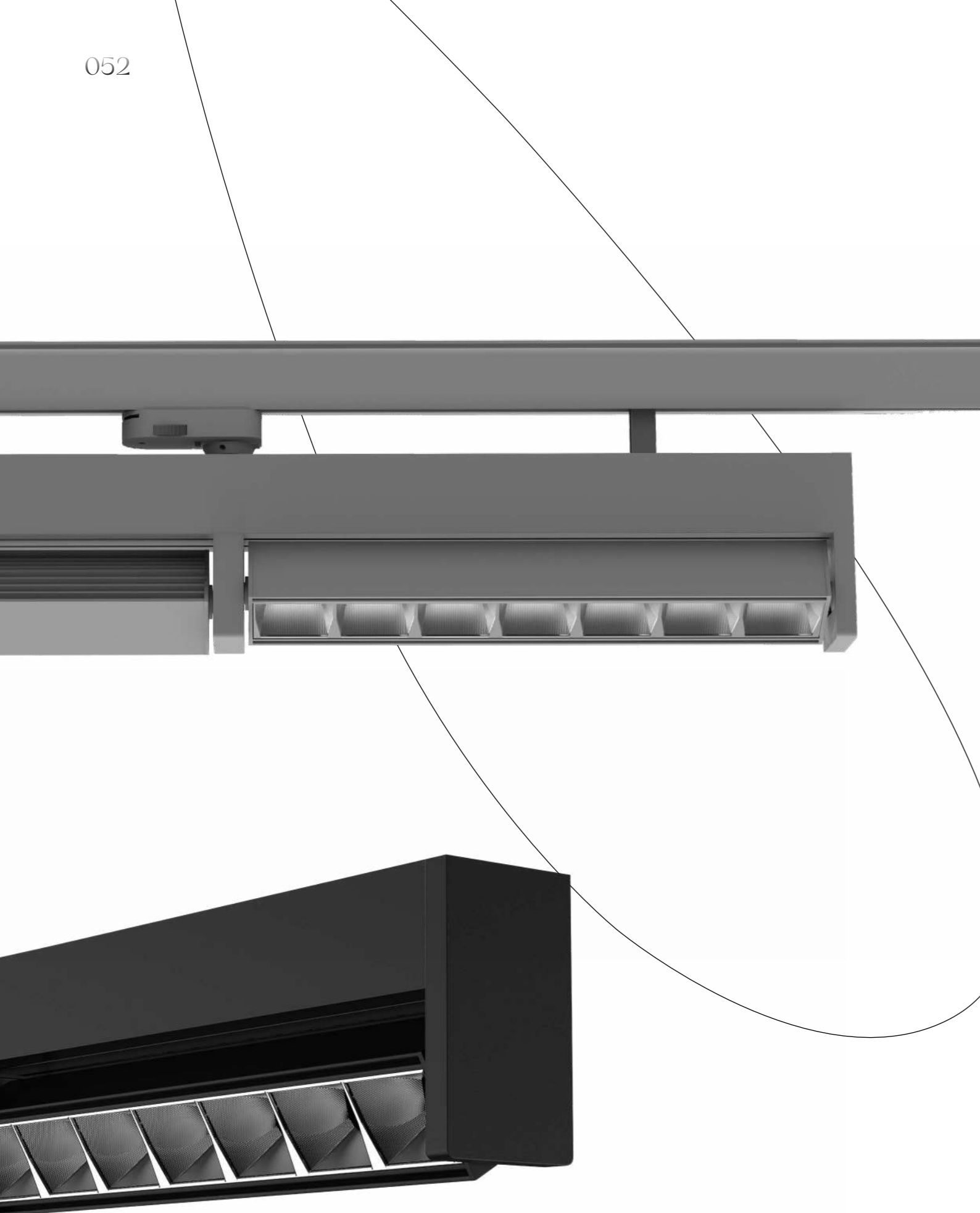

Die speziell abgestimmten Optiken von TARIO ermöglichen ein innovatives Beleuchtungssystem, das speziell für die optimale Ausleuchtung von Regalen entwickelt wurde. Darum sorgt TARIO für eine leistungsstarke und blendfreie Beleuchtung von oben bis unten, sodass jedes Produkt perfekt präsentiert und ausgeleuchtet wird - ohne dunklen Ecken oder Schatten. Ausgehend von der Zone über dem Regal (Gondelkopfzone), über die Reckzone, Sichtzone, Griffzone, Bückzone bis hin zum Boden - passendes Licht in jeder Situation ist garantiert.

The specially tuned optics of TARIO enable an innovative lighting system designed specifically for the optimal lighting of shelves. Therefore, TARIO ensures powerful and glare-free lighting from top to bottom, so that every product is perfectly presented and illuminated - without dark corners or shadows. From the zone above the shelf (gondola head zone), through the reach zone, sight zone, grip zone, and bend zone to the floor - appropriate light in every situation is guaranteed.

Mit dem Einsatz der einzigartigen TARIO Matrix-Steuerung kann der Fokus der Beleuchtung unterschiedlicher Regalhöhen noch weiter differenziert und optimiert werden. Sowohl die Gondelkopfzone (Zone 1), Reck- und Sichtzone (Zone 2), Griff- und Bückzone (Zone 3) als auch der Boden (Zone 4) kann individuell bestromt und ausgeleuchtet werden. Diese Schwerpunktverschiebung geschieht in einer subtilen Art und Weise und wird nur unterbewusst wahrgenommen.

With the use of the unique TARIO matrix control, the focus of the lighting for different shelf heights can be further differentiated and optimized. The gondola head zone (Zone 1), reach and sight zone (Zone 2), grip and bend zone (Zone 3), and the floor (Zone 4) can be individually powered and illuminated. This shift in focus happens in a subtle way and is only subconsciously perceived.

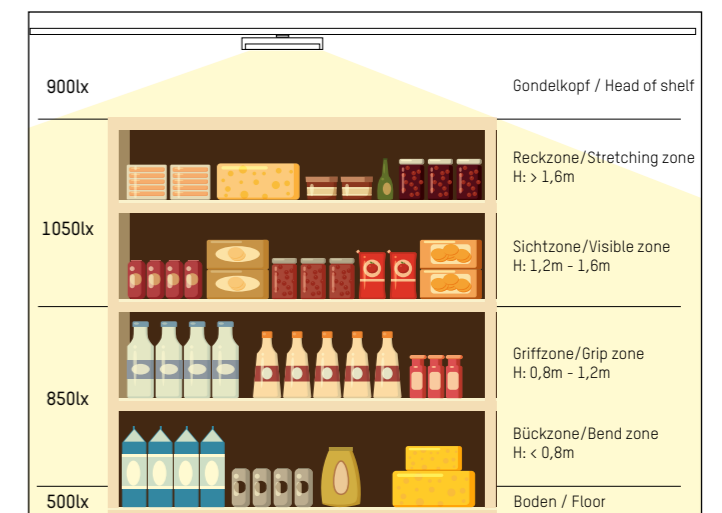
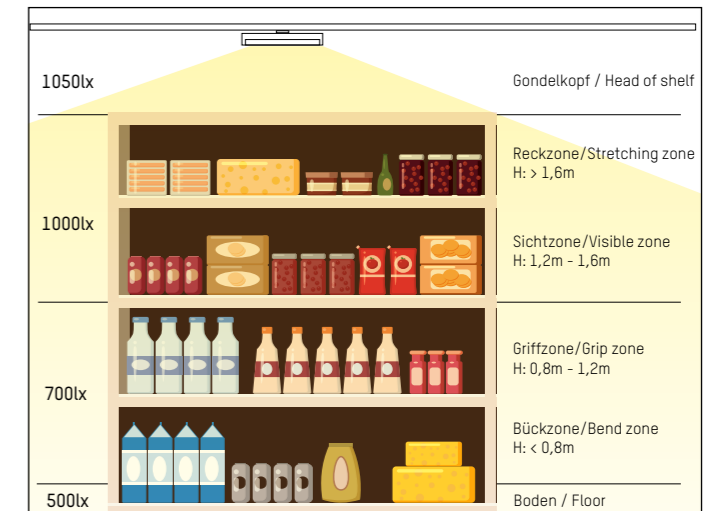

TARIO MATRIX

TARIO TRACK

TARIO TRACK 220-240V AC 50/60Hz Design: INHOUSE IP20 CE

Stromschienenstrahler mit Raster-Optik · pulverbeschichtet · Lichteinsätze werkzeuglos tauschbar und schwenkbar mittels Rastmechanismus
Track spotlight with louvre optics · powder-coated · light inserts can be replaced without tools and swivelled using a latching mechanism
Faretti a binario con ottica a lamelle - verniciati a polvere - inserti possono essere sostituiti senza attrezzi e orientati con un meccanismo di bloccaggio
Projecteur avec optique à grille - surface fine texture peinte - inserts interchangeables sans outil et orientables grâce à un mécanisme d'encliquetage

TARIO 1 TRACK

CODE	SYS W	LUMEN
186-0113RL0BCWXXY	26,5 / 32	3210 - 4840

TARIO 2 TRACK

CODE	SYS W	LUMEN
186-0123RL0BCWXXY	53,5 / 64	6420 - 9740

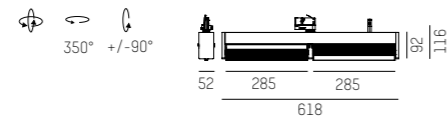
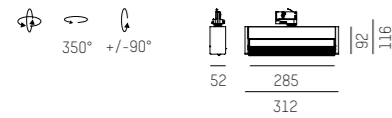

COMPLETE CODE						
R = REFLECTOR	L = LIGHT INSERT	B = LIGHT BEAM	C = CRI	W = LIGHT COLOUR	XX = COLOUR	Y = DIMMABLE
basic = 1	MID OUTPUT = 1 26,5W (Tario 1 TRACK) 53,5W (Tario 2 TRACK)	asymmetric = 1	CRI>80 = 1	W2 LED 2700K = 3	grey = 04	switchable = 0
asymmetric = 2		double asymm. = 2	CRI>90 = 2	W3 LED 3000K = 9	white = 05	PULSE DALI = p
opal = 4		(only Tario 2 version)		W35 LED 3500K = 7	black = 06	SMART BLUETOOTH = b
microprisma = 5	HIGH OUTPUT = 2 32W (Tario 1 TRACK) 64W (Tario 2 TRACK)	oval = 3		W4 LED 4000K = 4		CASAMBI = c
basic dark = 6		wide 60° = 4				
		extra wide 90° = 5				

TARIO MATRIX TRACK

TARIO MATRIX TRACK 220-240V AC 50/60Hz Design: INHOUSE IP20 CE

Stromschienenstrahler mit Raster-Optik · pulverbeschichtet · Lichteinsätze werkzeuglos tauschbar und schwenkbar mittels Rastmechanismus
Track spotlight with louvre optics · powder-coated · light inserts can be replaced without tools and swivelled using a latching mechanism
Faretti a binario con ottica a lamelle - verniciati a polvere - inserti possono essere sostituiti senza attrezzi e orientati con un meccanismo di bloccaggio
Projecteur avec optique à grille - surface fine texture peinte - inserts interchangeables sans outil et orientables grâce à un mécanisme d'encliquetage

TARIO 1 MATRIX TRACK

CODE	SYS W	LUMEN
186-01133LSBCWXXY	26,5 / 32	3210 - 4840

TARIO 2 MATRIX TRACK

CODE	SYS W	LUMEN
186-01233LSBCWXXY	53,5 / 64	6420 - 9740

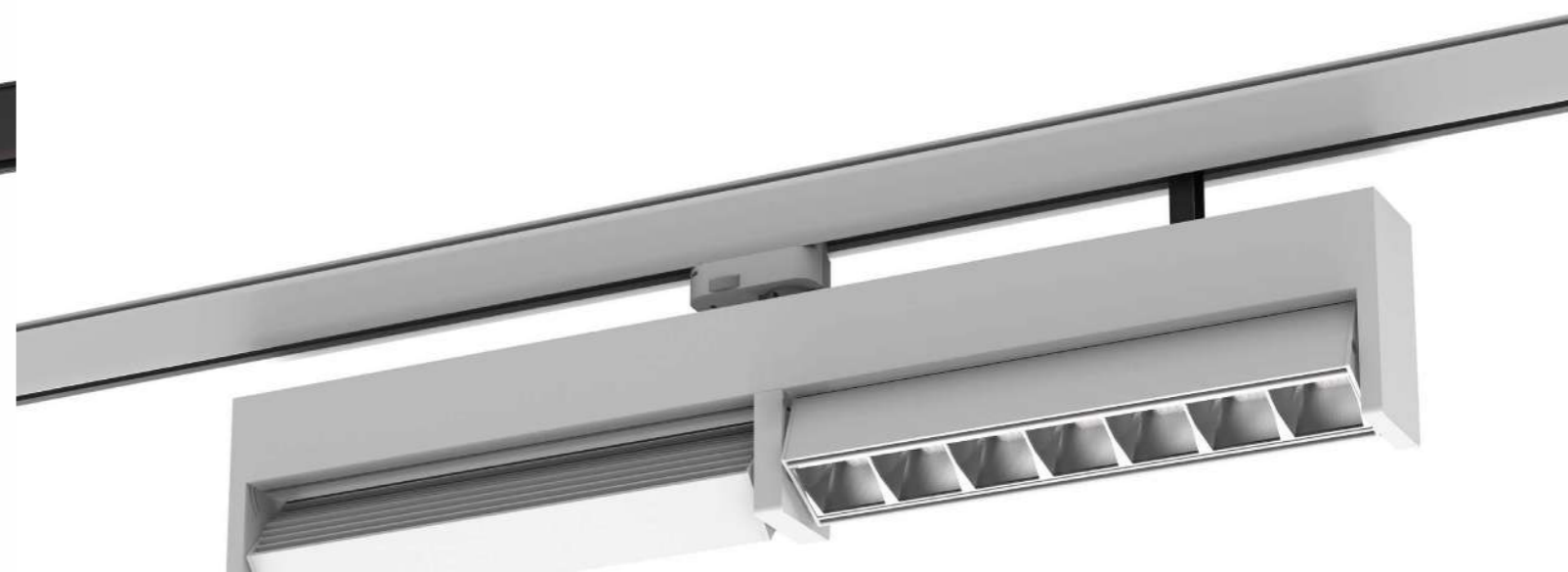
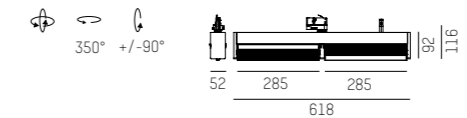

COMPLETE CODE						
L = LIGHT INSERT	S = SWITCH	B = LIGHT BEAM	C = CRI	W = LIGHT COLOUR	XX = COLOUR	Y = DIMMABLE
MID OUTPUT = 1 26,5W (Tario 1 TRACK) 53,5W (Tario 2 TRACK)	Dip-Switch = 2	asymmetric = 1	CRI>80 = 1	W2 LED 2700K = 3	grey = 04	switchable = 0
	Digital = 3	double asymm. = 2	CRI>90 = 2	W3 LED 3000K = 9	white = 05	PULSE DALI = p
		(only Tario 2 version)		W35 LED 3500K = 7	black = 06	SMART BLUETOOTH = b
HIGH OUTPUT = 2 32W (Tario 1 TRACK) 64W (Tario 2 TRACK)		oval = 3		W4 LED 4000K = 4		CASAMBI = c
		wide 60° = 4				
		extra wide 90° = 5				

TARIO TRACK

TARIO DOUBLE TRACK

220-240V AC 50/60Hz Design: INHOUSE

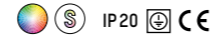

Stromschienenstrahler mit Raster-Optik · pulverbeschichtet · Lichteinsätze werkzeuglos tauschbar und schwenkbar mittels Rastmechanismus
 Track spotlight with louvre optics · powder-coated · light inserts can be replaced without tools and swivelled using a latching mechanism
 Faretti a binario con ottica a lamelle - verniciati a polvere - inserti possono essere sostituiti senza attrezzi e orientati con un meccanismo di bloccaggio
 Projecteur avec optique à grille - surface fine texture peinte - inserts interchangeables sans outil et orientables grâce à un mécanisme d'encliquetage

TARIO DOUBLE TRACK

CODE	SYS W	LUMEN
186-0124RL0BCWXXY	53,5 / 64	6420 - 9740

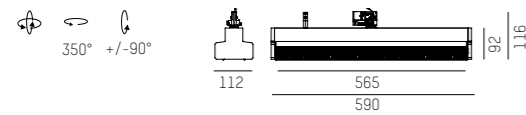

COMPLETE CODE						
R = REFLECTOR	L = LIGHT INSERT	B = LIGHT BEAM	C = CRI	W = LIGHT COLOUR	XX = COLOUR	Y = DIMMABLE
basic = 1	MID OUTPUT = 1 53,5W	asymmetric = 1	CRI>80 = 1	W2 LED 2700K = 3	grey = 04	switchable = 0
asymmetric = 2		double asymm. = 2	CRI>90 = 2	W3 LED 3000K = 9	white = 05	PULSE DALI = p
opal = 4		oval = 3		W35 LED 3500K = 7	black = 06	SMART BLUETOOTH = b
microprisma = 5	HIGH OUTPUT = 2 64W	wide 60° = 4		W4 LED 4000K = 4		CASAMBI = c
basic dark = 6		extra wide 90° = 5				

TARIO MATRIX TRACK

TARIO DOUBLE MATRIX TRACK

220-240V AC 50/60Hz Design: INHOUSE

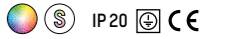

Stromschienenstrahler mit Raster-Optik · pulverbeschichtet · Lichteinsätze werkzeuglos tauschbar und schwenkbar mittels Rastmechanismus
 Track spotlight with louvre optics · powder-coated · light inserts can be replaced without tools and swivelled using a latching mechanism
 Faretti a binario con ottica a lamelle - verniciati a polvere - inserti possono essere sostituiti senza attrezzi e orientati con un meccanismo di bloccaggio
 Projecteur avec optique à grille - surface fine texture peinte - inserts interchangeables sans outil et orientables grâce à un mécanisme d'encliquetage

TARIO DOUBLE MATRIX TRACK

CODE	SYS W	LUMEN
186-01243LSBCWXXY	53,5 / 64	6420 - 9740

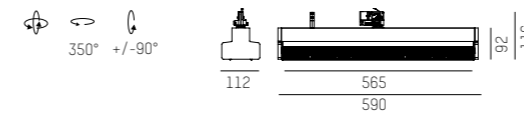

COMPLETE CODE						
L = LIGHT INSERT	S = SWITCH	B = LIGHT BEAM	C = CRI	W = LIGHT COLOUR	XX = COLOUR	Y = DIMMABLE
MID OUTPUT = 1 53,5W	Dip-Switch = 2	asymmetric = 1	CRI>80 = 1	W2 LED 2700K = 3	grey = 04	switchable = 0
	Digital = 3	double asymm. = 2	CRI>90 = 2	W3 LED 3000K = 9	white = 05	PULSE DALI = p
		oval = 3		W35 LED 3500K = 7	black = 06	SMART BLUETOOTH = b
HIGH OUTPUT = 2 64W		wide 60° = 4		W4 LED 4000K = 4		CASAMBI = c
		extra wide 90° = 5				



TARIO R

TARIO R

220-240V AC

50/60Hz

Design: INHOUSE

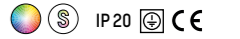

Einbaustrahler mit Raster-Optik · pulverbeschichtet · Lichteinsätze werkzeuglos tauschbar und schwenkbar mittels Rastmechanismus
 Recessed spotlight with louvre optics · powder-coated · light inserts can be replaced without tools and swivelled using a latching mechanism
 Incasso con ottica a lamelle - verniciati a polvere - inserti possono essere sostituiti senza attrezzi e orientati con un meccanismo di bloccaggio
 Spot encastré avec optique à grille - surface fine texture peinte - inserts interchangeables sans outil et orientables grâce à un mécanisme d'encliquetage

CODE	LED W	LUMEN
186-0013RL0BCWXX0	24 / 29	3210 - 4840

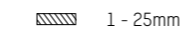
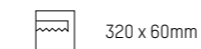
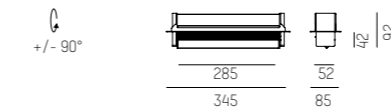

LED CONVERTER	DIMM
24-127484n	not dimmable
24-127490	driver Dali dimm.
701-1001	driver BLUETOOTH dimm.
24-127630	driver CASAMBI dimm.



COMPLETE CODE					
R = REFLECTOR	L = LIGHT INSERT	B = LIGHT BEAM	C = CRI	W = LIGHT COLOUR	XX = COLOUR
<ul style="list-style-type: none"> basic = 1 asymmetric = 2 opal = 4 microprisma = 5 basic dark = 6 	<ul style="list-style-type: none"> MID OUTPUT = 1 24W HIGH OUTPUT = 2 29W 	<ul style="list-style-type: none"> asymmetric = 1 oval = 3 wide 60° = 4 extra wide 90° = 5 	<ul style="list-style-type: none"> CRI>80 = 1 CRI>90 = 2 	<ul style="list-style-type: none"> LED 2700K = 3 LED 3000K = 9 LED 3500K = 7 LED 4000K = 4 	<ul style="list-style-type: none"> grey = 04 white = 05 black = 06

3-PHASE TRACK



3-PHASE TRACK

220-240V AC 50/60Hz

3-Phasen Stromschiene aus Aluminiumprofil · pulverbeschichtet · Installation als Aufbau, Einbau- und Pendelmontage · Zubehör separat ordern
 3-phase rail made of aluminium · surface powder-coated · surface, recessed or suspended mount · Order accessories separately
 Binario trifase in alluminio · superficie verniciata a polveri · Montaggio a soffitto, incasso o sospensione · Ordinare gli accessori separatamente
 Rail à 3 phases en aluminium · surface thermolaquée · Montage à plafon, encastré ou suspension · Commander les accessoires séparément

3-PHASEN SCHIENE AUFBAU / ABGEHÄNGT 3-PHASE TRACK SURFACE / PENDANT	LÄNGE LENGHT	3-PHASEN SCHIENE EINBAU 3-PHASE TRACK RECESSED	LÄNGE LENGHT
208-1910410X	1000mm	208-1910510X	1000mm
208-1910420X	2000mm	208-1910520X	2000mm
208-1910430X	3000mm	208-1910530X	3000mm
208-1910440X	4000mm		

COMPLETE CODE FOR TRACK

X = COLOUR

s black = 2	w white = 3	g grey = 5
--------------------	--------------------	-------------------

ENDKAPPE

END PIECE

208-1917041X

Alle Stromschiene müssen mit einer Endkappe versehen werden!

All track endings have to be equipped with endpieces!

BIEGEWERKZEUG

BENDING TOOL

208-19135121

Zum Biegen der Stromleiter bei gekürzter Schiene für easy conductor bending with shortened rails

POWER FEED

ENDEINSPEISUNG END POWER FEED	LÄNGE LENGHT	MITTELEINSPEISUNG CENTER POWER FEED	LÄNGE LENGHT
208-1917011X	66mm	208-1917014X	100mm
208-1917012X	66mm		

COMPLETE CODE

X = COLOUR

g grey = 1	s black = 2	w white = 3
-------------------	--------------------	--------------------

JUNCTION

LINEARVERBINDER LINEAR JUNCTION ELECTRIC

208-1917021X

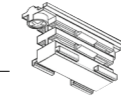

FLEXVERBINDER FLEXIBLE JUNCTION

208-1917023X
biegbar 0 - 360° / bendable 0 - 360°

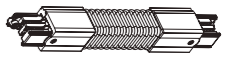

WINKELVERBINDER FLEXIBLE JUNCTION

208-1917024X
biegbar 60 - 300° / bendable 60 - 300°

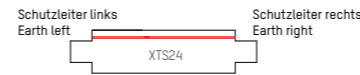
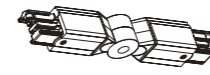

X-VERBINDER X-JUNCTION

208-1917038X
Mit Einspeisemöglichkeit / with optional power feed

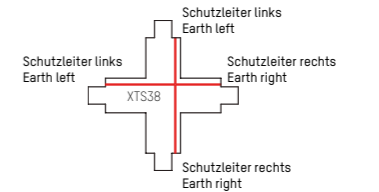
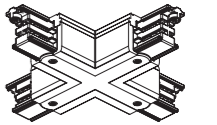

L-VERBINDER L-JUNCTION

208-1917034X
Mit Einspeisemöglichkeit / with optional power feed

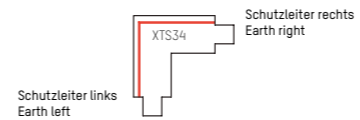
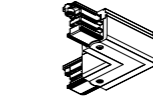

L-VERBINDER L-JUNCTION

208-1917035X
Mit Einspeisemöglichkeit / with optional power feed

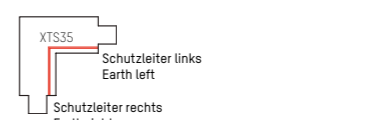
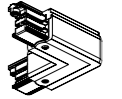

T-VERBINDER T-JUNCTION

208-1917036X
Mit Einspeisemöglichkeit / with optional power feed

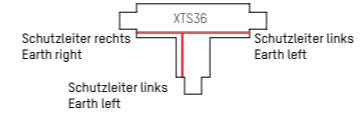
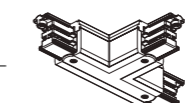

T-VERBINDER T-JUNCTION

208-1917037X
Mit Einspeisemöglichkeit / with optional power feed

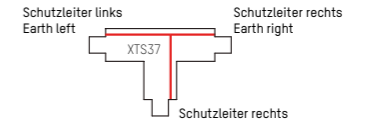
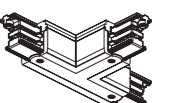

T-VERBINDER T-JUNCTION

208-1917039X
Mit Einspeisemöglichkeit / with optional power feed

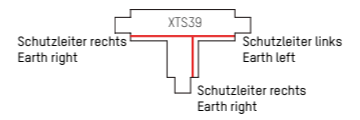
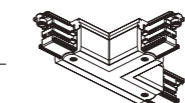

T-VERBINDER T-JUNCTION

208-1917040X
Mit Einspeisemöglichkeit / with optional power feed

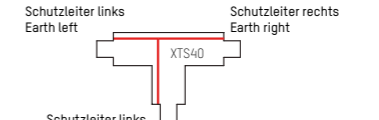
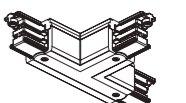

COMPLETE CODE

X = COLOUR

g grey = 1	s black = 2	w white = 3
-------------------	--------------------	--------------------

3-PHASE TRACK DIM



3-PHASE PULSE DALI TRACK

220-240V AC 50/60Hz

IP20

3-Phasen Stromschiene aus Aluminiumprofil · pulverbeschichtet · Installation als Aufbau, Einbau- und Pendelmontage · Zubehör separat ordern
 3-phase rail made of aluminium · surface powder-coated · surface, recessed or suspended mount · Order accessories separately
 Binario trifase in alluminio · superficie verniciata a polveri · Montaggio a soffitto, incasso o sospensione · Ordinare gli accessori separatamente
 Rail à 3 phases en aluminium · surface thermolaquée · Montage à plafon, encastré ou suspension · Commander les accessoires séparément

3-PHASEN SCHIENE AUFBAU / ABGEHÄNGT 3-PHASE TRACK SURFACE / PENDANT	LÄNGE LENGHT	3-PHASEN SCHIENE EINBAU 3-PHASE TRACK RECESSED	LÄNGE LENGHT
208-1910610X	1000mm	208-1910650X	1000mm
208-1910620X	2000mm	208-1910660X	2000mm
208-1910630X	3000mm	208-1910670X	3000mm
208-1910640X	4000mm		

COMPLETE CODE FOR TRACK		
X = COLOUR		
black = 2	white = 3	grey = 5

ENDKAPPE
END PIECE
208-1917041X
Alle Stromschiene müssen mit einer Endkappe versehen werden!
All track endings have to be equipped with endpieces!

BIEGEWERKZEUG
BENDING TOOL
208-19135121
Zum Biegen der Stromleiter bei gekürzter Schiene for easy conductor bending with shortened rails

POWER FEED

ENDEINSPEISUNG END POWER FEED	LÄNGE LENGHT	MITTELEINSPEISUNG CENTER POWER FEED	LÄNGE LENGHT
208-191c611X	90mm	208-191nc614X	150mm
208-191c612X	90mm		

COMPLETE CODE		
X = COLOUR		
grey = 1	black = 2	white = 3

JUNCTION

LINEARVERBINDER ELEKTRISCH
LINEAR JUNCTION ELECTRIC
208-191d621X

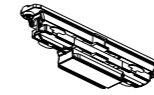

FLEXVERBINDER
FLEXIBLE JUNCTION
208-191c623X
biegbar 0 - 360° / bendable 0 - 360°

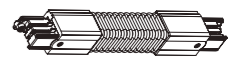

X-VERBINDER
X-JUNCTION
208-191nc638X

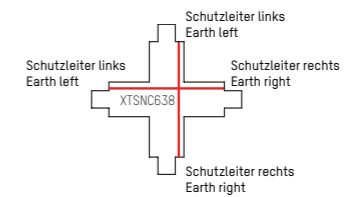
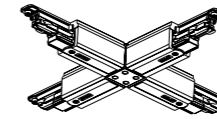

Mit Einspeisemöglichkeit / with optional power feed

L-VERBINDER
L-JUNCTION
208-191nc634X

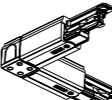

L-VERBINDER
L-JUNCTION
208-191nc635X

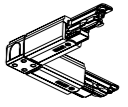

Mit Einspeisemöglichkeit / with optional power feed

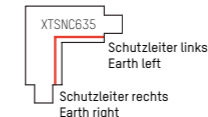
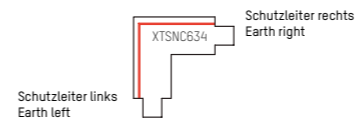

T-VERBINDER
T-JUNCTION
208-191nc636X

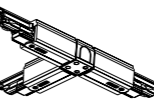

T-VERBINDER
T-JUNCTION
208-191nc637X

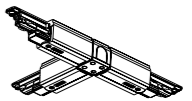

Mit Einspeisemöglichkeit / with optional power feed

Mit Einspeisemöglichkeit / with optional power feed

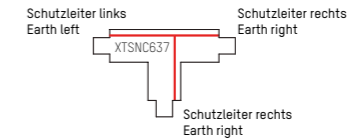
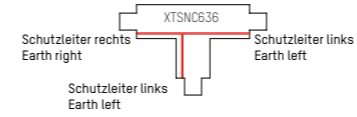

T-VERBINDER
T-JUNCTION
208-191nc639X

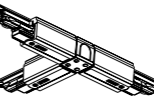

T-VERBINDER
T-JUNCTION
208-191nc640X

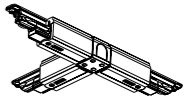



Mit Einspeisemöglichkeit / with optional power feed

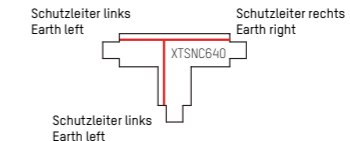
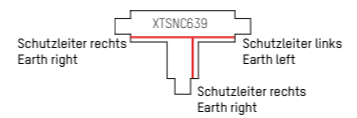

Mit Einspeisemöglichkeit / with optional power feed



COMPLETE CODE		
X = COLOUR		
grey = 1	black = 2	white = 3

FIXING COMPONENTS



ABHÄNGESSET SUSPENSION SET	FARBE COLOUR	LÄNGE LENGHT
208-19013		1500mm
208-19012		1500mm
208-19011		1500mm

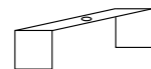

ABHÄNGESSET SUSPENSION SET	FARBE COLOUR	LÄNGE LENGHT
208-19015		3000mm
208-19016		3000mm
208-19014		3000mm

MONTAGEBÜGEL INSTALLATION BRACKET	FARBE COLOUR
775-hv60000808	

für Einbauschiene, inkl Schraube M 4x60
for recessed track, incl screw M 4x60



DECKENHALTERUNG SURFACE FIXATION	FARBE COLOUR
208-19180123	
208-19180122	
208-19180121	

DECKENBEFESTIGUNG SURFACE FIXATION	FARBE COLOUR
208-19180116	
208-19180115	
208-19180114	

DECKENBEFESTIGUNGSSET CEILING FIXATION	FARBE COLOUR
639-ad	

Dübel und Schrauben nicht enthalten
screws and dowels are not include



SCHNELLEBEFESTIGUNGSSET FAST FIXATION SET	FARBE COLOUR
639-as	

Stahlseil und Deckenbefestigungsset separat ordern
order steel cable & ceiling fixation separately

KABELABHÄNGUNGSSET CABLE SUSPENSION SET	LÄNGE LENGTH
639-s3000	3000mm
639-s6000	6000mm

beliebig kürzbar, Ø 1,2mm
cut to any length, Ø 1,2mm

DECKENBEFESTIGUNGSSET CEILING FIXATION	FARBE COLOUR
5-plsb	

2 Halterungen + 2 Kabelfixierungen
2 holders + 2 cable fix



SEIL SCHNELLEBEFESTIGUNGSSET HOCH CABLE FAST FIXATION SET HIGH	FARBE COLOUR
639-ash	

Bietet Platz für ein 20mm Installationsrohr zw. Stromschiene und Befestigungsset;
Stahlseil und Deckenbefestigungsset separat ordern
Allows space for a 20mm installation pipe between the busbar and the fixing set;
order steel cable & ceiling fixation separately

STAHLSEIL STEEL CABLE	LÄNGE LENGTH
208-19190501	per meter

beliebig kürzbar, Ø 1,5mm
cut to any length, Ø 1,5mm





COMPONENTS



MULTIADAPTER TRACK
ADAPTER ADAPTER
208-19130681
208-19130685
208-19130684

MULTIADAPTER TRACK
ADAPTER ADAPTER
208-19130698
208-19130697
208-19130696

BLINDADAPTER TRACK
BLINDADAPTER BLINDADAPTER
208-19162173

ADAPTER	FARBE	LxBxH
ADAPTER	COLOUR	LxWxH
208-19130681		84x32x55
208-19130685		84x32x55
208-19130684		84x32x55

Tragkraft: 10kg /payload: 10kg

ADAPTER	FARBE	LxBxH
ADAPTER	COLOUR	LxWxH
208-19130698		70x32x40
208-19130697		70x30x40
208-19130696		70x32x40

Tragkraft: 5kg /payload: 5kg

BLINDADAPTER	FARBE
BLINDADAPTER	COLOUR
208-19162173	

Tragkraft: 10kg,
zur Aufhängung von Leuchten
payload: 10kg,
for mounting luminaires

MULTIADAPTER PULSE DALI TRACK
ADAPTER ADAPTER
208-19137403
208-19137402
208-19137401



MULTIADAPTER PULSE DALI TRACK
ADAPTER ADAPTER
208-19137503
208-19137502
208-19137501

SCHUKO ADAPTER BLINDADAPTER	FARBE COLOUR
208-19130678	

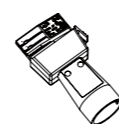
16A





COMPONENTS

NIPPEL NIPPLE	FARBE COLOUR	GRÖSSE SIZE
208-19130551		M 13x1, H: 12
208-19130571		M 10x1, H: 8



zum Befestigen von Strahlern am Adapter
for fixation spotlight to adapter



ZUGENTLASTUNG CORD GRIP	FARBE COLOUR
208-19825016	
208-19825019	

Zum Aufschrauben auf Alu-Nippel M10
for fixation on barrel nipple M10



ZUGENTLASTUNG CORD GRIP	FARBE COLOUR
208-19130133	
208-19130132	

Zum Aufschrauben auf Alu-Nippel M13
for fixation on barrel nipple M13



COVER FOR 3-PHASE TRACK

ABDECKPLATTE COVERPLATE	FARBE COLOUR
208-19172303	
208-19172302	
208-19172301	

für T, L und X Verbinder nur für Einbauschiene
for T, L and X junction for recessed track only

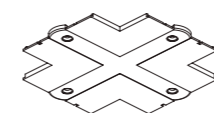

COVER FOR 3-PHASE TRACK

ABDECKPLATTE COVERPLATE	FARBE COLOUR
208-19172103	
208-19172102	
208-19172101	

für Mittel- und Endeinspeisung nur für Einbauschiene
for center and end power feed for recessed track only

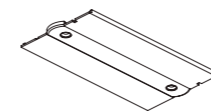



COVER FOR 3-PHASE PULSE DALI TRACK

ABDECKPLATTE COVERPLATE	FARBE COLOUR
208-191nc6303	
208-191nc6302	
208-191nc6301	

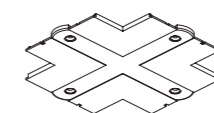
für T, L und X Verbinder nur für Einbauschiene
for T, L and X junction for recessed track only





COVER FOR 3-PHASE PULSE DALI TRACK

ABDECKPLATTE COVERPLATE	FARBE COLOUR
208-191nc6103	
208-191nc6102	
208-191nc6101	

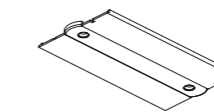
für Mittel- und Endeinspeisung nur für Einbauschiene
for center and end power feed for recessed track only



ADAPTER FÜR DEKOHAKEN ADAPTER FOR DECO HOOK	FARBE COLOUR
208-19160143	
208-19160142	
208-19160141	

zum einklippen in die Schiene
to clip into rail



DEKOHAKEN DECO HOOK	FARBE COLOUR
208-19160111	

Adapter separat ordern
order adapter separately



3-PHASE TRACK COMPONENTS



Intersport, St. Pölten, Austria, Photo: Joachim Rauch

SAVO 10

SAVO 10 R

220-240V AC

50/60Hz

Design: INHOUSE



Einbaudownlight aus Aluminium · Oberfläche pulverbeschichtet · vakuumbedampfter Alurefektor · Strahlerelement dreh- und schwenkbar
 Aluminium downlighter · surface powder-coated · vacuum deposited reflector · swiveling and tilting
 Incasso in alluminio · superficie verniciata a polveri · ottiche in 3 fasci di emissione · girevole e orientabile
 Encastré en aluminium · surface laquée en poudre · réflecteur en 3 angles d'émission · tournant et pivotant

CODE	LED W / mA	LUMEN
633-00101RRWWXXv2	12 / 350	1420 - 1700
	17 / 500	1960 - 2350
	24 / 700	2620 - 3140

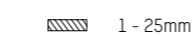
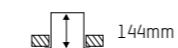
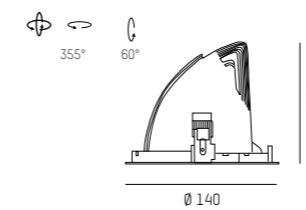

LED CONVERTER	mA	DIM	FOR
30-880006	350	not dimmable	1 x SAVO 10 12W
30-880106	500	not dimmable	1 x SAVO 10 17W
30-880206	700	not dimmable	1 x SAVO 10 24W
24-127490	350 - 700	DALI dimmable	1 x SAVO 10 12 - 24W
700-3004	350 - 700	CASAMBI dimmable	1 x SAVO 10 12 - 24W



COMPLETE CODE

RR = REFLECTOR

- 15° spot = **02**
- 28° medium = **05**
- 40° flood = **08**

WW = LIGHT COLOUR

- LED 2700K = **43** PREMIUM CRI>90
- LED 3000K = **49** PREMIUM CRI>90
- LED 4000K = **24** CRI>90

XX = COLOUR

- white = **05**





Object Carpet GmbH / City of Visions, Denkendorf, Germany, Photo: Markus Guhl

SAVO 20 ROUND

SAVO 20 ROUND R
 220-240V AC 50/60Hz Design: INHOUSE

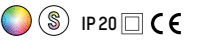

Einbaudownlight aus Aluminium · Oberfläche pulverbeschichtet · vakuumbedampfter Alurefektor · Strahlerelement schwenkbar
 Aluminium downlighter · surface powder-coated · vacuum deposited reflector · tilting
 Incasso in alluminio · superficie verniciata a polveri · ottiche in 3 fasci di emissione · orientabile
 Encastré en aluminium · surface laquée en poudre · réflecteur en 3 angles d'émission · pivotant

CODE	LED W / mA	LUMEN
633-00201RRWWXXv2	12 / 350	1460 - 1740
	17 / 500	2030 - 2410
	24 / 700	2730 - 3240

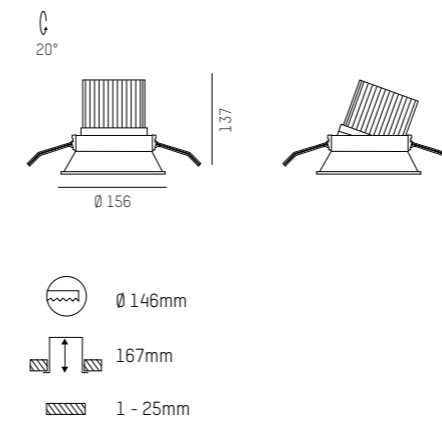

LED CONVERTER	mA	DIM	FOR
30-880006	350	not dimmable	1 x SAVO 20 ROUND 12W
30-880106	500	not dimmable	1 x SAVO 20 ROUND 17W
30-880206	700	not dimmable	1 x SAVO 20 ROUND 24W
24-127490	350 - 700	DALI dimmable	1 x SAVO 20 ROUND 12 - 24W
700-3004	350 - 700	CASAMBI dimmable	1 x SAVO 20 ROUND 12 - 24W



COMPLETE CODE		
RR = REFLECTOR	WW = LIGHT COLOUR	XX = COLOUR
<ul style="list-style-type: none"> 16° spot = 02 24° medium = 05 40° flood = 08 	<ul style="list-style-type: none"> LED 2700K = 43 PREMIUM CRI>90 LED 3000K = 49 PREMIUM CRI>90 LED 4000K = 24 CRI>90 	<ul style="list-style-type: none"> white = 05 black = 06



Romeo & Juliet, Perg, Austria, Photo: Joachim Rauch

SAVO 20 SQUARE

SAVO 20 SQUARE R

220-240V AC

50/60Hz

Design: INHOUSE



Einbaudownlight aus Aluminium · Oberfläche pulverbeschichtet · vakuumbedampfter Alureflector · Strahlerelement dreh- und schwenkbar
 Aluminium downlighter · surface powder-coated · vacuum deposited reflector · tilting and pivoting
 Incasso in alluminio · superficie verniciata a polveri · ottiche in 3 fasci di emissione · orientabile
 Encastré en aluminium · surface laquée en poudre · réflecteur en 3 angles d'émission · pivotant

SAVO 20 SQUARE R

CODE	LED W / mA	LUMEN
	12 / 350	1460 - 1740
633-00301RRWWXXv2	17 / 500	2030 - 2410
	24 / 700	2730 - 3240

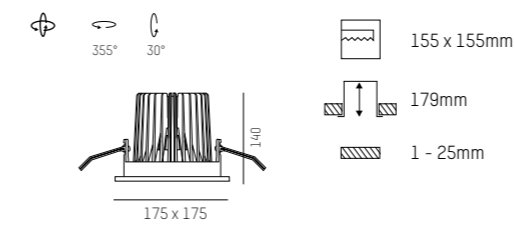

SAVO 20 SQUARE DOUBLE R

CODE	LED W / mA	LUMEN
	2 x 12 / 2 x 350	2930 - 3480
633-00302RRWWXXv2	2 x 17 / 2 x 500	4060 - 4820
	2 x 24 / 2 x 700	5470 - 6480

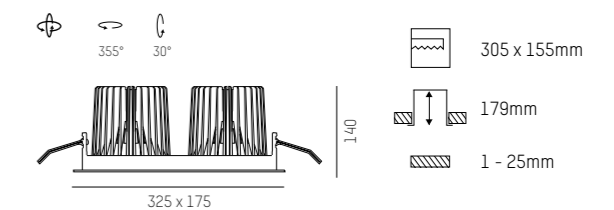

LED CONVERTER	mA	DIM	ORDER FOR
30-880006	350	not dimmable	1 x SAVO 20 SQUARE 12W / 2 x SAVO 20 SQUARE DOUBLE 2 x 12W
30-880106	500	not dimmable	1 x SAVO 20 SQUARE 17W / 2 x SAVO 20 SQUARE DOUBLE 2 x 17W
30-880206	700	not dimmable	1 x SAVO 20 SQUARE 24W / 2 x SAVO 20 SQUARE DOUBLE 2 x 24W
24-127490	350 - 700	DALI dimmable	1 x SAVO 20 SQUARE 12 - 24W / 2 x SAVO 20 SQUARE DOUBLE 2 x 12 - 24W
700-3004	350 - 700	CASAMBI dimmable	1 x SAVO 20 SQUARE 12 - 24W / 2 x SAVO 20 SQUARE DOUBLE 2 x 12 - 24W



COMPLETE CODE

RR = REFLECTOR	WW = LIGHT COLOUR	XX = COLOUR
<ul style="list-style-type: none"> 16° spot = 02 24° medium = 05 40° flood = 08 	<ul style="list-style-type: none"> LED 2700K = 43 PREMIUM CRI>90 LED 3000K = 49 PREMIUM CRI>90 LED 4000K = 24 CRI>90 	<ul style="list-style-type: none"> white = 05 black = 06



Kreisel & Electrics, Rainbach, Austria, Planning/realisation: Ben Elmecker, Photo: Kreisel Electric / Martin Pröll

SAVO 20 S SQUARE

SAVO 20 S SQUARE R

220-240V AC

50/60Hz

Design: INHOUSE



Einbaudownlight aus Aluminium · Oberfläche pulverbeschichtet · vakuumbedampfter Alurefektor · Strahlerelement dreh- und schwenkbar
 Aluminium downlighter · surface powder-coated · vacuum deposited reflector · tilting and pivoting
 Incasso in alluminio · superficie verniciata a polveri · ottiche in 3 fasci di emissione · orientabile
 Encastré en aluminium · surface laquée en poudre · réflecteur en 3 angles d'émission · pivotant

SAVO 20 S SQUARE R

CODE	LED W / mA	LUMEN
633-00501RRWWXXv2	12 / 350	1260 - 1550
	18 / 500	1710 - 2110

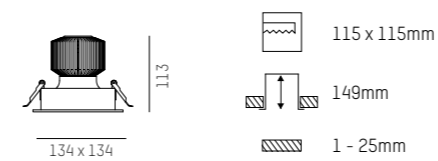

SAVO 20 S SQUARE DOUBLE R

CODE	LED W / mA	LUMEN
633-00502RRWWXXv2	2 x 12 / 2 x 350	2520 - 3100
	2 x 18 / 2 x 500	3420 - 4220

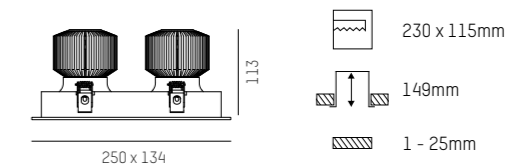

LED CONVERTER	mA	DIM	ORDER FOR
30-880006	350	not dimmable	1 x SAVO 20 S SQUARE 12W / 2 x SAVO 20 S SQUARE DOUBLE 2 x 12W
30-880106	500	not dimmable	1 x SAVO 20 S SQUARE 18W / 2 x SAVO 20 S SQUARE DOUBLE 2 x 18W
24-127490	350 - 500	DALI dimmable	1 x SAVO 20 S SQUARE 12 - 18W / 2 x SAVO 20 S SQUARE DOUBLE 2 x 12 - 18W
700-3004	350 - 500	CASAMBI dimmable	1 x SAVO 20 S SQUARE 12 - 18W / 2 x SAVO 20 S SQUARE DOUBLE 2 x 12 - 18W



COMPLETE CODE		
RR = REFLECTOR	WW = LIGHT COLOUR	XX = COLOUR
<ul style="list-style-type: none"> 24° medium = 05 45° flood = 08 	<ul style="list-style-type: none"> LED 2700K = 43 PREMIUM CRI>90 LED 3000K = 49 PREMIUM CRI>90 LED 4000K = 24 CRI>90 	<ul style="list-style-type: none"> white = 05 black = 06



Dentist Spiritus & Sanger, Erkelenz, Germany

NOW 2 ROUND

NOW 2 ROUND R

220-240V AC

50/60Hz

Design: INHOUSE



Einbaudownlight aus Aluminium · Oberflache pulverbeschichtet · vakuumbedampfter Alurefektor · Strahlerelement schwenkbar
 Aluminium downlighter · surface powder-coated · vacuum deposited reflector · tilting
 Incasso in alluminio · superficie verniciata a polveri · ottiche in 3 fasci di emissione · orientabile
 Encastr en aluminium · surface laquee en poudre · reflecteur en 3 angles d'emission · pivotant

CODE	LED W / mA	LUMEN
635-00100RRWWXX	12 / 350 17 / 500	1270 - 1710 1740 - 2350

30°

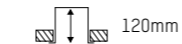
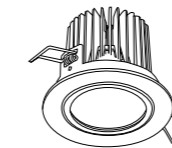
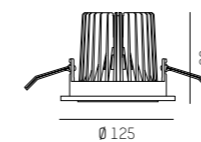

LED CONVERTER	mA	DIM	FOR
30-880006	350	not dimmable	1 x NOW 2 ROUND 12W
30-880106	500	not dimmable	1 x NOW 2 ROUND 17W
24-127490	350 - 500	DALI dimmable	1 x NOW 2 ROUND 12 - 17W
700-3004	350 - 500	CASAMBI dimmable	1 x NOW 2 ROUND 12 - 17W



COMPLETE CODE

RR = BEAM ANGLE

- 16° spot = 02
- 25° medium = 05
- 40° flood = 08

WW = LIGHT COLOUR

- LED 2700K = 43 PREMIUM CRI>90
- LED 3000K = 49 PREMIUM CRI>90
- LED 4000K = 24 CRI>90

XX = COLOUR

- grey = 04
- white = 05
- black = 06



Capera Linked Living Studios, Vienna, Austria, Photo: Joachim Rauch

NOW 2 SQUARE

NOW 2 SQUARE R

220-240V AC

50/60Hz

Design: INHOUSE



Einbaudownlight aus Aluminium · Oberfläche pulverbeschichtet · vakuumbedampfter Alurefektor · Strahlerelement schwenkbar
 Aluminium downlighter · surface powder-coated · vacuum deposited reflector · tilting
 Incasso in alluminio · superficie verniciata a polveri · ottiche in 3 fasci di emissione · orientabile
 Encastré en aluminium · surface laquée en poudre · réflecteur en 3 angles d'émission · pivotant

NOW 2 SQUARE R

CODE	LED W / mA	LUMEN
635-00200RRWWXX	12 / 350	1490 - 1710
	17 / 500	2040 - 2350

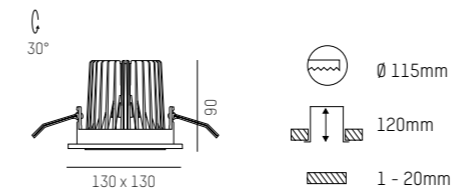

NOW 2 SQUARE DOUBLE R

CODE	LED W / mA	LUMEN
635-00300RRWWXX	2 x 12 / 2 x 350	2980 - 3430
	2 x 17 / 2 x 500	4090 - 4710

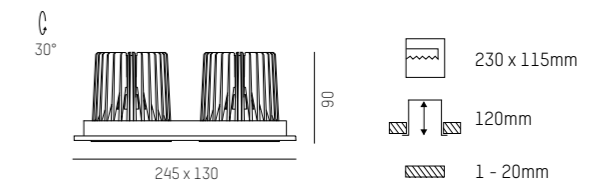

LED CONVERTER	mA	DIM	ORDER FOR
30-880006	350	not dimmable	1 x NOW 2 SQUARE 12W / 2 x NOW 2 SQUARE DOUBLE 2 x 12W
30-880106	500	not dimmable	1 x NOW 2 SQUARE 17W / 2 x NOW 2 SQUARE DOUBLE 2 x 17W
24-127490	350 - 500	DALI dimmable	1 x NOW 2 SQUARE 12 - 17W / 2 x NOW 2 SQUARE DOUBLE 2 x 12 - 17W
700-3004	350 - 500	CASAMBI dimmable	1 x NOW 2 SQUARE 12 - 17W / 2 x NOW 2 SQUARE DOUBLE 2 x 12 - 17W



COMPLETE CODE		
RR = BEAM ANGLE	WW = LIGHT COLOUR	XX = COLOUR
<ul style="list-style-type: none"> ☐ 16° spot = 02 ☐ 25° medium = 05 ☐ 40° flood = 08 	<ul style="list-style-type: none"> W2 LED 2700K = 43 PREMIUM CRI>90 W3 LED 3000K = 49 PREMIUM CRI>90 W4 LED 4000K = 24 CRI>90 	<ul style="list-style-type: none"> ☐ grey = 04 ☐ white = 05 ☐ black = 06



Mercedes Showroom, Dubai, VAE, Photo: yasserphotography.com

ONLY XS



ONLY XS R
220-240V AC 50/60Hz Design: INHOUSE

Einbaudownlight aus Aluminium · Oberfläche pulverbeschichtet · vakuumbedampfter Alurefektor · Strahlerelement dreh- und schwenkbar
Aluminium downlighter · surface powder-coated · vacuum deposited reflector · swiveling and tilting
Incasso in alluminio · superficie verniciata a polveri · ottiche in 4 fasci di emissione · girevole e orientabile
Encastré en aluminium · surface laquée en poudre · réflecteur en 4 angles d'émission · tournant et pivotant

CODE	LED W / mA	LUMEN
619-00101RRWWXXv1	12 / 350	1500 - 1730
	17 / 500	2080 - 2390
	24 / 700	2780 - 3200

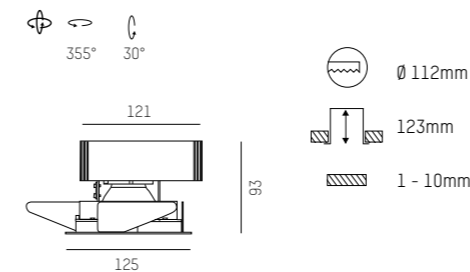

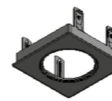
EINBAUGEHÄUSE 1 RECESSED HOUSING 1	FARBE COLOUR	
544-124	grey	
544-125	white	
544-126	black	

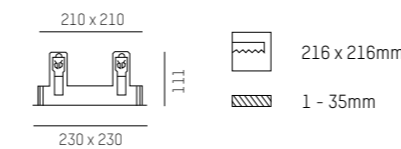



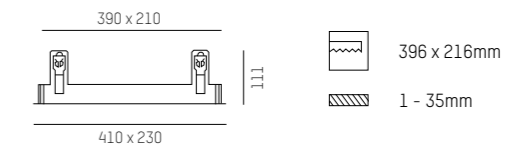







EINBAUGEHÄUSE 2 RECESSED HOUSING 2	FARBE COLOUR	
544-224	grey	
544-225	white	
544-226	black	



LED CONVERTER	mA	DIM	FOR
30-880006	350	not dimmable	1 x ONLY XS 12W
30-880106	500	not dimmable	1 x ONLY XS 17W
30-880206	700	not dimmable	1 x ONLY XS 24W
24-127490	350 - 700	DALI dimmable	1 x ONLY XS 12 - 27W
700-3004	350 - 700	CASAMBI dimmable	1 x ONLY XS 12 - 27W



COMPLETE CODE		
RR = BEAM ANGLE	WW = LIGHT COLOUR	XX = COLOUR
 15° spot = 02	 LED 2700K = 43 PREMIUM CRI>90	 grey = 04
 20° medium = 05	 LED 3000K = 49 PREMIUM CRI>90	 white = 05
 35° flood = 08	 LED 4000K = 24 CRI>90	 black = 06
 60° wide flood = 09		



Intersport Bachler, Schladming, Austria, Photo: Joachim Rauch

ONLY M



ONLY M R

220-240V AC

50/60Hz

Design: INHOUSE

Einbaudownlight aus Aluminium · Oberfläche pulverbeschichtet · vakuumbedampfter Alurefektor · Strahlerelement dreh- und schwenkbar
 Aluminium downlighter · surface powder-coated · vacuum deposited reflector · swiveling and tilting
 Incasso in alluminio · superficie verniciata a polveri · ottiche in 3 fasci di emissione · girevole e orientabile
 Encastré en aluminium · surface laquée en poudre · réflecteur en 3 angles d'émission · tournant et pivotant

CODE	LED W / mA	LUMEN
	23 / 700	2740 - 3350
619-00201RRWWXXv1	30 / 900	3430 - 4190
	36 / 1050	3910 - 4780

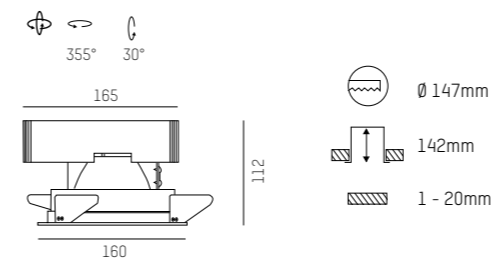

EINBAUGEHÄUSE 1 RECESSED HOUSING 1	FARBE COLOUR	
544-114	grey	
544-115	white	
544-116	black	

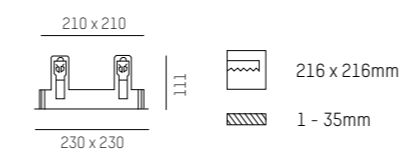

EINBAUGEHÄUSE 2 RECESSED HOUSING 2	FARBE COLOUR	
544-214	grey	
544-215	white	
544-216	black	

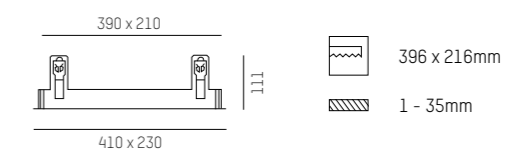

LED CONVERTER	mA	DIM	FOR
30-880206	700 - 1050	not dimmable	1 x ONLY M 23 - 36W
24-127490	700 - 1050	DALI dimmable	1 x ONLY M 23 - 36W
700-3004	700 - 1050	CASAMBI dimmable	1 x ONLY M 23 - 36W



COMPLETE CODE

RR = BEAM ANGLE	WW = LIGHT COLOUR	XX = COLOUR
17° spot = 02	LED 2700K = 43 PREMIUM CRI>90	grey = 04
29° medium = 05	LED 3000K = 49 PREMIUM CRI>90	white = 05
40° flood = 08	LED 4000K = 24 CRI>90	black = 06



more information



OTIN



Capera Linked Living Studios, Vienna, Austria, Photo: Joachim Rauch



WE Electric, Bad Leonfelden, Austria, Photo: Joachim Rauch



Deutsche Bank, Salzburg, Austria, Photo: Joachim Rauch

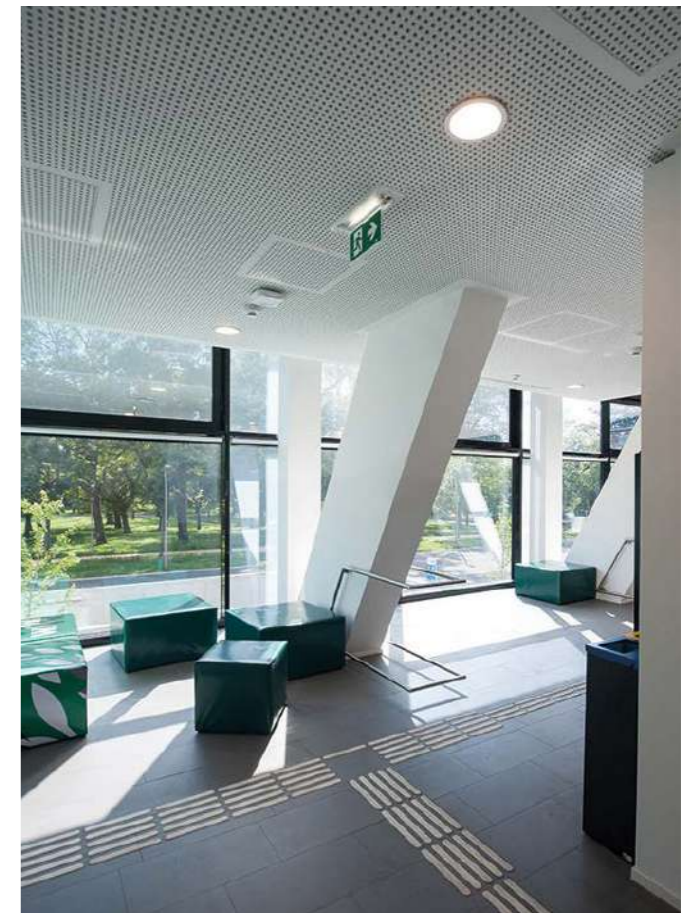

University of Economics, Vienna, Austria, Photo: Joachim Rauch

OTIN



Hotel Aigo, Aigen, Austria
Photo: Joachim Rauch

BRILLIANCE AND EFFICIENCY COMBINED

OTIN ist ein wahres Effizienzwunder und setzt mit einer Leistungsfähigkeit von über 175 lm/W neue Maßstäbe. Die flache und modulare Bauweise eröffnet eine unkomplizierte Integration in nahezu jede Zwischendecke, und das mit nur wenigen Handgriffen. Ob als Neuinstallation oder vor allem auch bei der Sanierung von bereits bestehenden Installationen überzeugt die Downlight-Serie auf ganzer Linie. OTIN kann ebenso mit einem Hoch-Frequenz-Bewegungssensor kombiniert werden und optionale Distanzhalter sorgen für zusätzliche Flexibilität und Stabilität im Einbau bei variablen Deckenausschnitten.

OTIN is the ultimate miracle in efficiency and sets new standards with a performance of more than 175 lm/W. The flat design allows for easy integration into almost any suspended ceiling in just a few simple steps. The downlight series represents a convincing solution across the board, whether for new installations or for renovations of existing projects. OTIN can be combined with high-frequency motion sensors and spacers ensure additional flexibility and stability during installation.

Design: INHOUSE

VARIATIONS



FORM



SIZES

	100 - 108 mm	150 - 170 mm	175 - 195 mm	200 - 220 mm
RECESSED	 1 - 25 mm 80mm Ø 120 57	 1 - 25 mm 80mm Ø 182 63	 1 - 25 mm 80mm Ø 207 63	 1 - 25 mm 80mm Ø 232 63
SURFACE	 114 Ø 192	 114 Ø 215	 114 Ø 215	 114 Ø 240
	OTIN S 7,5 - 10,5W 1100 - 1800lm	OTIN M 7,5 - 17,5W 1150 - 3100lm	OTIN L 8 - 19W 1200 - 3400lm	OTIN XL 8,5 - 20,5W 1300 - 3600lm

CORE COLOURS



LED COLOURS



OPTICS & COVERS



REFLECTORS

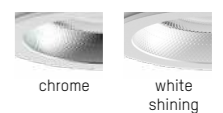

SPECIALS





OTIN R MOUNTING

Unsere Downlightserie OTIN, lässt sich dank der 4 unterschiedlichen Größenvarianten in nahezu jeden Deckenausschnitt perfekt einfügen und passt sich so flexibel an die individuellen Gegebenheiten der Räumlichkeiten an. Somit sind sowohl bei einer Neuinstallation und auch bei der Sanierung von bereits bestehenden Installationen, keine Einschränkungen gegeben.

Our OTIN downlight series can be perfectly integrated into almost any ceiling section thanks to the four different size variants, making it flexibly adaptable to the individual conditions of the rooms. This means that there are no limitations, whether for a new installation or for the renovation of existing installations.

OTIN R

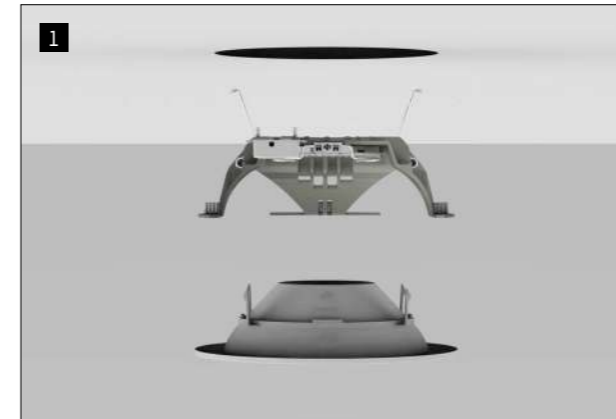

Kühlkörper und Reflektoreinsatz in passender Größe auswählen
Select cooling body and reflector insert in suitable size



Distanzhalter optional konfigurierbar wenn nötig
spacers optional configurable if necessary

Kühlkörper in Deckenausschnitt einsetzen und Distanzhalter je nach Bedarf wegbrechen (0 - 20mm)
Insert cooling body into ceiling cut-out and break away spacers as required (0 - 20mm)

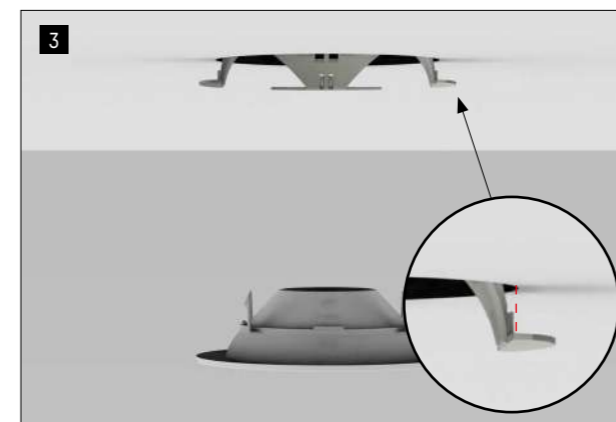

Kühlkörper mit passender Anzahl an Distanzhaltern in den Deckenausschnitt einsetzen
Insert the cooling body with the appropriate number of spacers into the ceiling cut-out

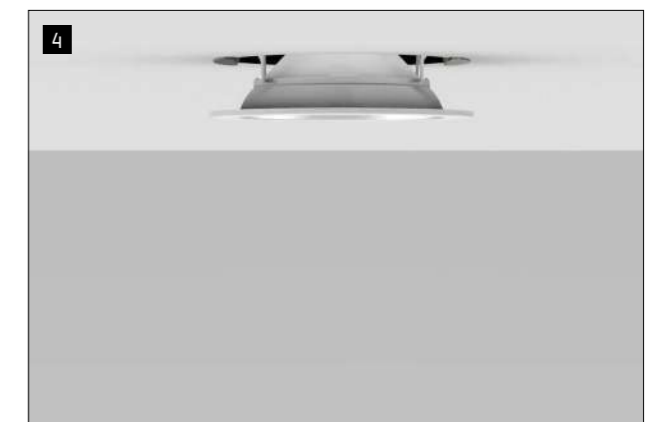

Reflektoreinsatz in den Kühlkörper einsetzen
Insert the reflector insert into the cooling body

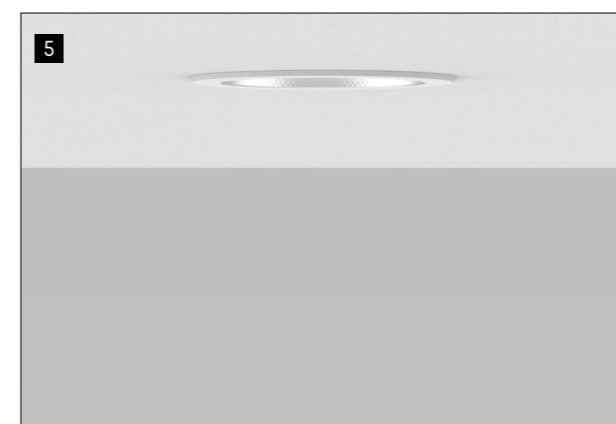

OTIN einschalten und brillantes Licht genießen
Switch on OTIN and enjoy brilliant light



MONTAGEVIDEO
MOUNTING VIDEO

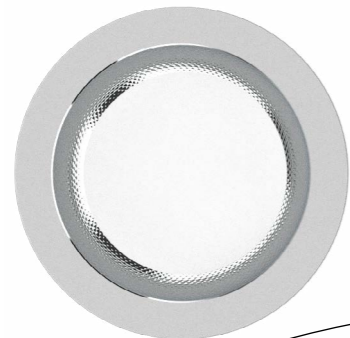

100 mm
7 - 10,5W
1100 - 1800lm

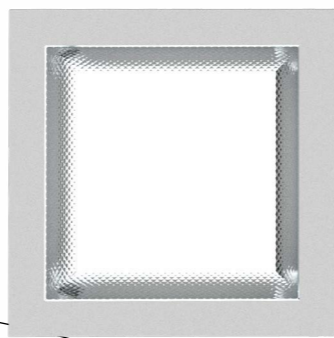

150 mm
7,5 - 17,5W
1150 - 3100lm

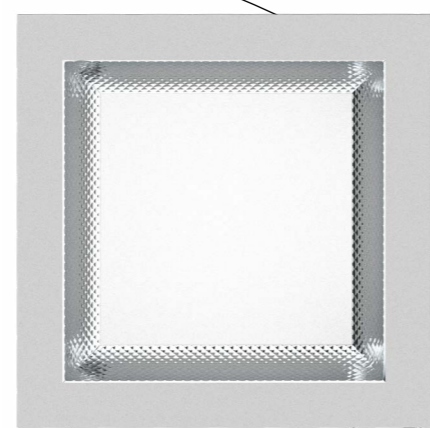

175 mm
8 - 19W
1200 - 3400lm

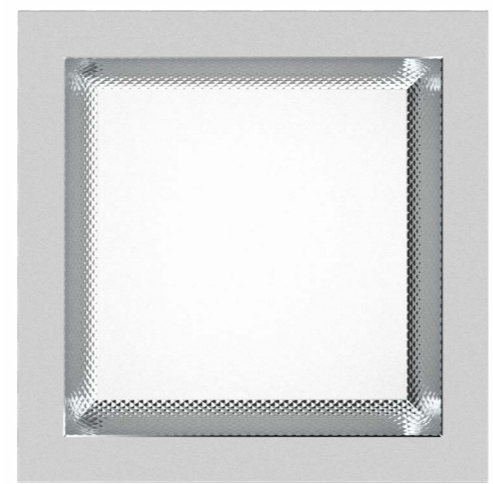

200 mm
8,5 - 20,5W
1300 - 3600lm

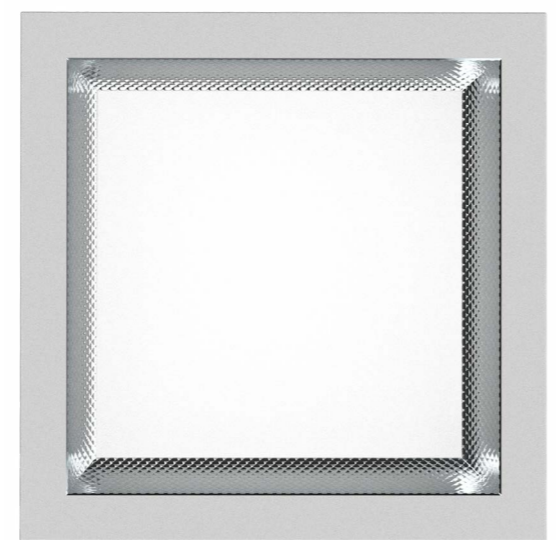

OPALABDECKUNG
OPAL COVER

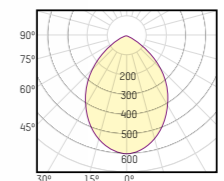

MIKROPRISMATISCHE ABDECKUNG
MICROPRISMATIC COVER

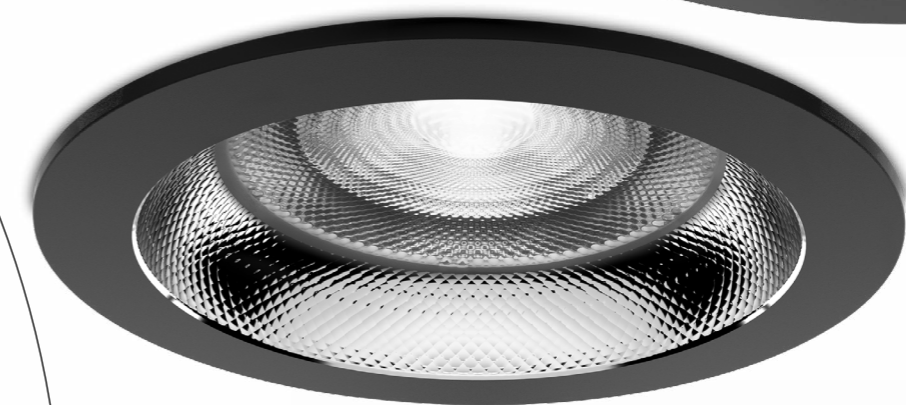
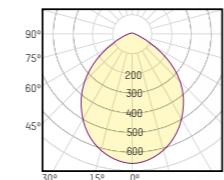

SYMMETRISCHE LINSE UGR<19
SYMMETRIC LENS UGR<19

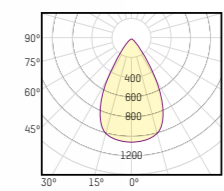

FÜR 150 & 175 mm
FOR 150 & 175 mm

ASYMMETRISCHE LINSE
ASYMMETRIC LENS

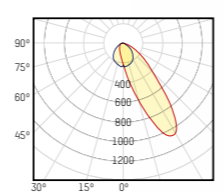

FÜR 150 & 175 mm
FOR 150 & 175 mm

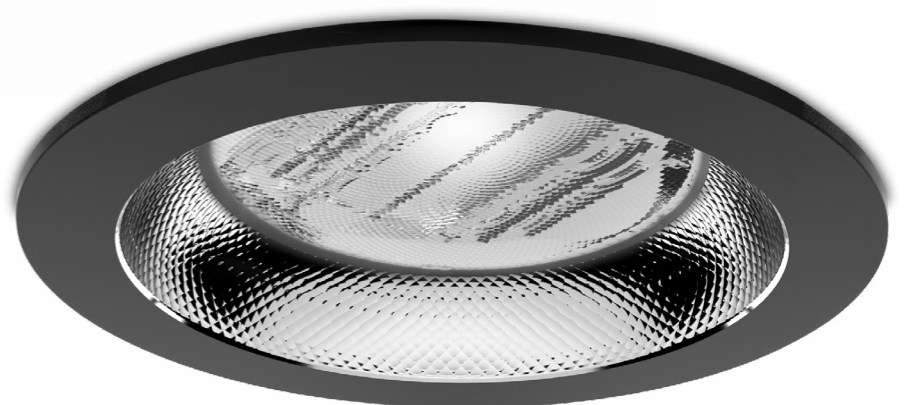

OTIN SIZES & OPTICS

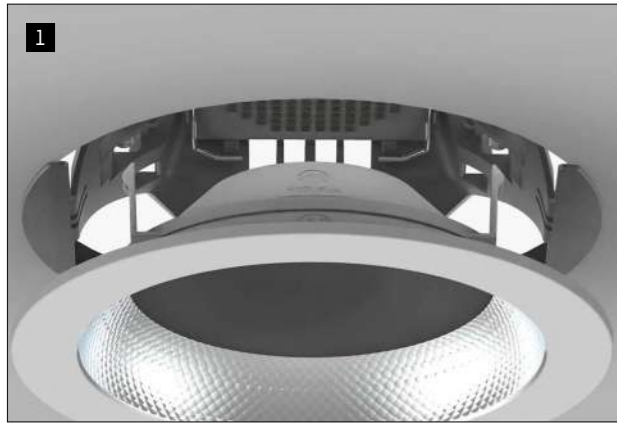

1 Reflektoreinsatz mit einem Handgriff abnehmen
Remove reflector insert in one easy step

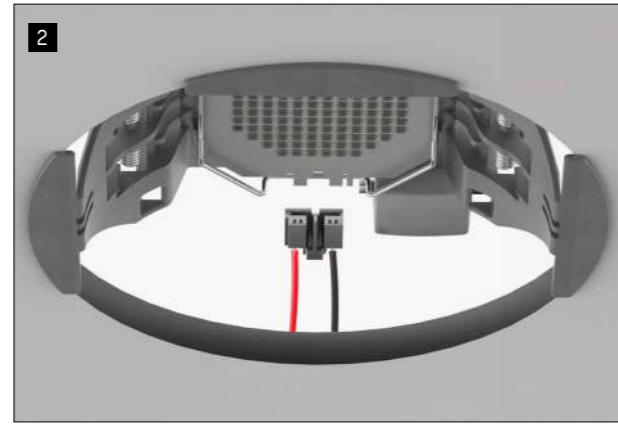

2 Stromverbindung von LED-Platine im Kühlkörper trennen
Disconnect the power connection from the LED board in the cooling body

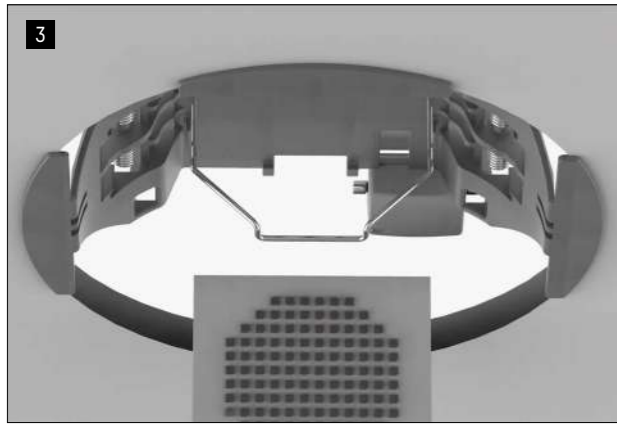

3 Befestigungsbügel öffnen und LED-Platine entfernen
Open the mounting bracket and remove the LED board

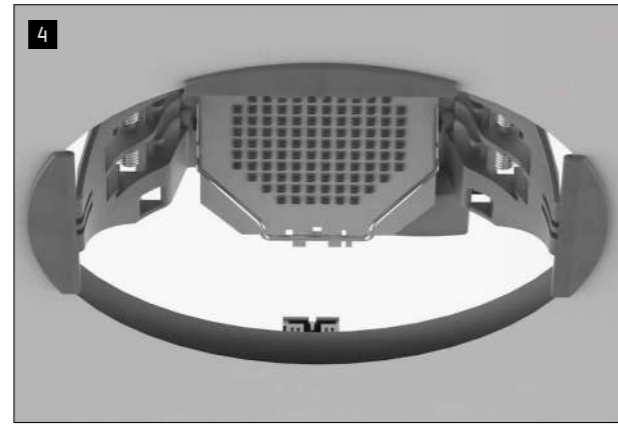

4 Neue LED-Platine einsetzen und Bügel schließen
Insert new LED board and close the mounting bracket

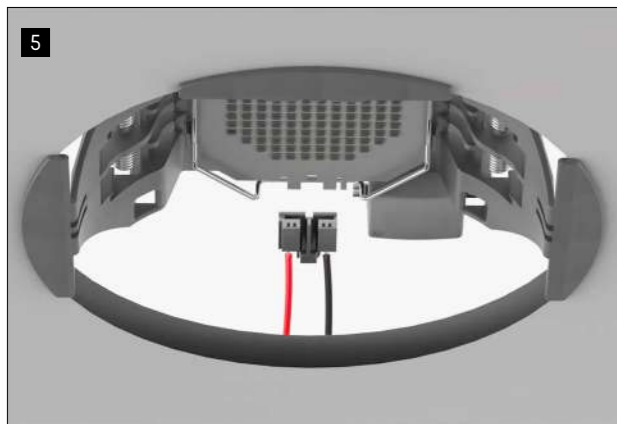

5 Stromkabel wieder an Platine anschließen
Reconnect the power cable to the board

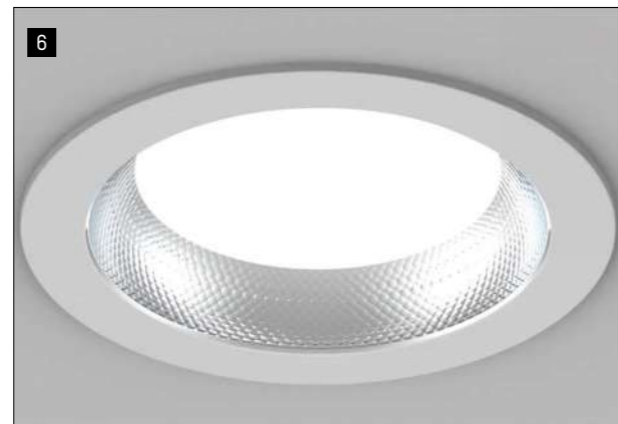

6 Reflektoreinsatz wieder anbringen
Refitting the reflector insert

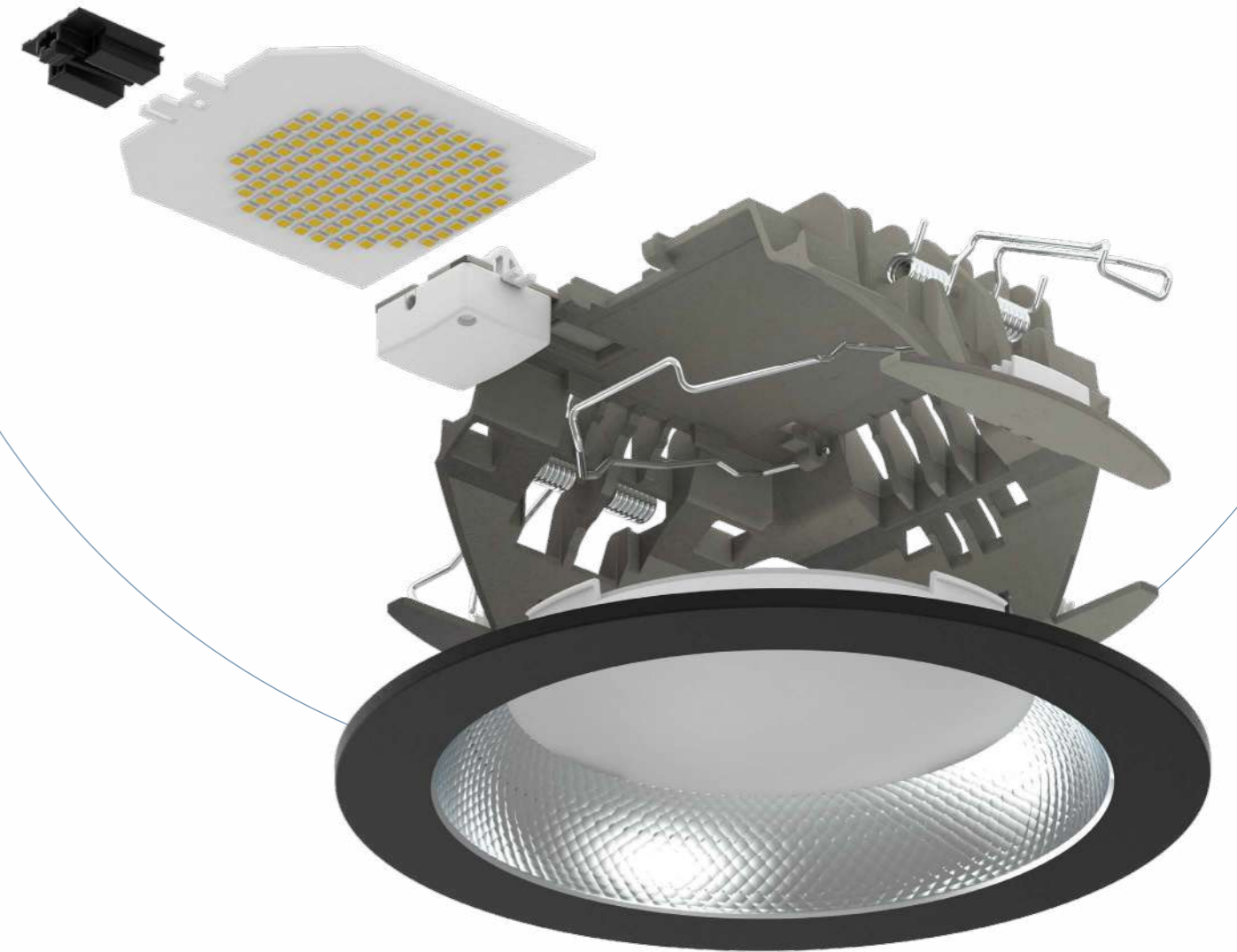

Einfach, schnell und werkzeuglos lässt sich das LED-Board von OTIN austauschen. Ein Feature, dass nicht nur Zeit, sondern auch Kosten spart, denn Effizienz betrifft nicht nur die Leistung, sondern auch den Umgang mit Ressourcen. Darum ist OTIN mehr als nur eine Beleuchtungslösung – es ist ein Statement für Nachhaltigkeit und Ressourcenschonung und das, ohne Kompromisse bei der Leistung einzugehen.

Simple, quick, and tool-free, the LED board of OTIN can be replaced. A feature that saves not only time but also costs, because efficiency concerns not only performance but also the handling of resources. That's why OTIN is more than just a lighting solution – it is a statement for sustainability and resource conservation, without compromising on performance.

OTIN X-CHANGE



Schachermayer, Vienna, Austria, Photo: Joachim Rauch

OTIN CONFIGURATOR

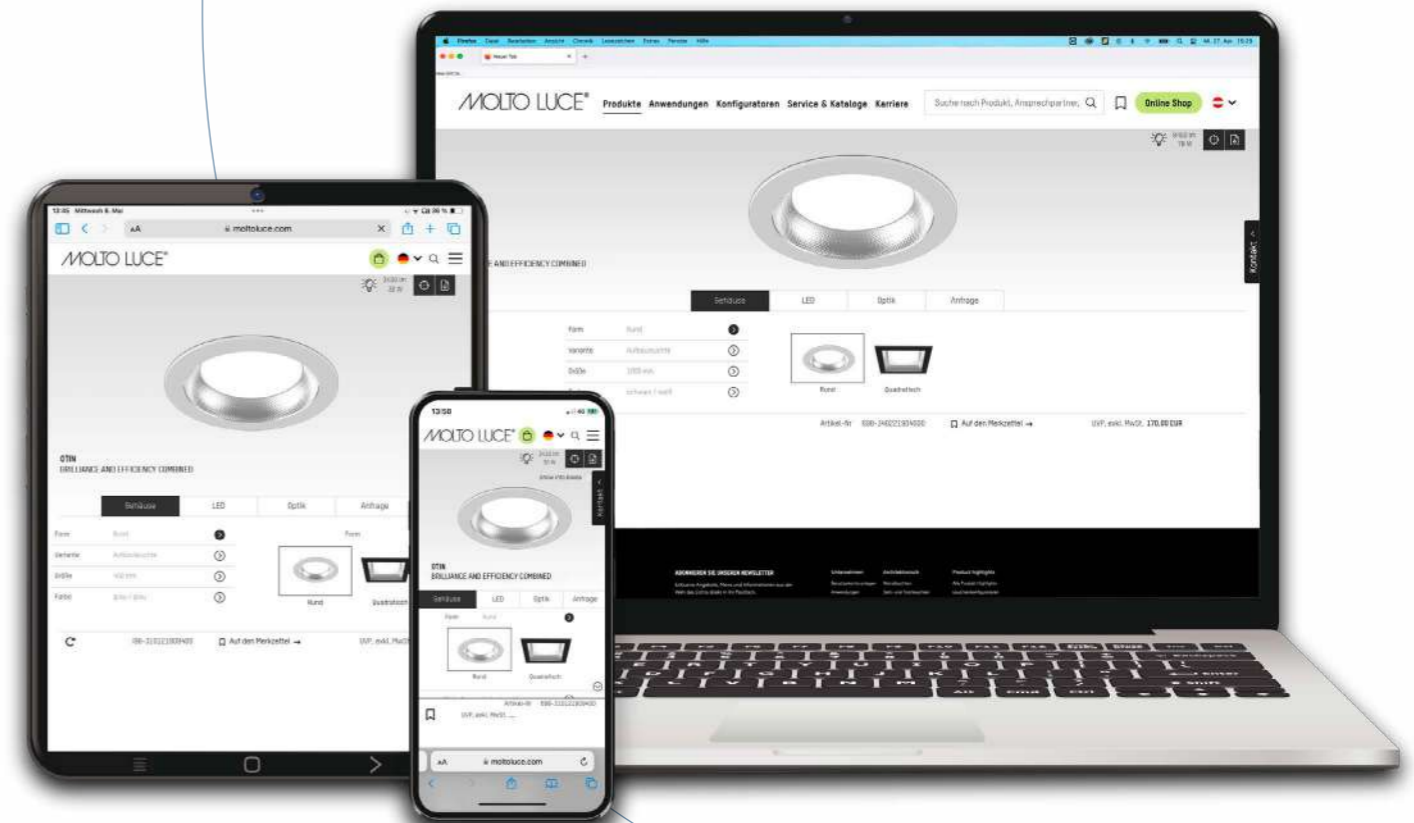



Residences Josefstadt, Vienna, Austria, Photo: Joachim Rauch

HOUSING

UNIVERSAL BETONEINBAUEHÄUSE UNIVERSAL CONCRETE HOUSING

GEHÄUSE / HOUSING	MATERIAL
332-2001	zinc plated

Einbauehäuse für Beton ohne Abdeckung, verzinktes Blech, je eine Schlaucheinführung DM 20mm und 25mm links und rechts, Abdeckung separat ordern

Recessed housing for concrete without cover, made of zinc-plated sheet, each tube insertion DM 20mm and 25mm left and right, order cover separately

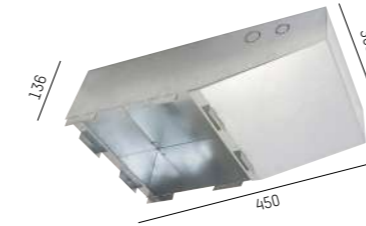

UNIVERSAL BETONEINBAUEHÄUSE UNIVERSAL CONCRETE HOUSING

GEHÄUSE / HOUSING	MATERIAL
332-1001	zinc plated

Einbauehäuse für Beton ohne Abdeckung, verzinktes Blech, je eine Schlaucheinführung DM 20mm und 25mm links und rechts, Abdeckung separat ordern

Recessed housing for concrete without cover, made of zinc-plated sheet, each tube insertion DM 20mm and 25mm left and right, order cover separately

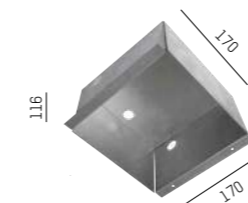

ABDECKUNG RUND / COVER ROUND

ABDECKUNG COVER	AUSSCHNITT CUTOUT	FÜR FOR
332-3r100	Ø 100	OTIN ROUND S R
332-3r115	Ø 115	ONLY XS R, NOW 2 ROUND R, SAVO 20 S R
332-3r150	Ø 150	ONLY M R, SAVO 20 ROUND R, OTIN ROUND M R, DARK NIGHT MEDIUM R
332-3r170	Ø 170	2 GO R
332-3r175	Ø 175	OTIN ROUND L R
332-3r200	Ø 200	OTIN ROUND XL R

Abdeckung inkl. Zentrierteil zu Betoneinbauehäuse 332-2001, verzinktes Blech, nicht für Sichtbeton geeignet

Cover incl. centering for recessed housing for concrete 332-2001, made of zinc-plated sheet, not adapted for exposed concrete

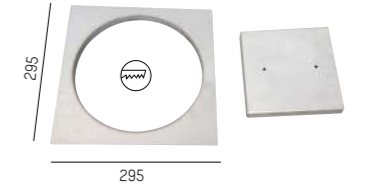

ABDECKUNG QUADRATISCH / COVER SQUARE

ABDECKUNG COVER	AUSSCHNITT CUTOUT	FÜR FOR
332-3q110	100 x 100	OTIN SQUARE S R
332-3q115	115 x 115	NOW 2 SQUARE R
332-3q155	150 x 150	OTIN SQUARE M R, SAVO 20 SQUARE R
332-3q175	175 x 175	OTIN SQUARE L R
332-3q200	200 x 200	OTIN SQUARE XL R

Abdeckung inkl. Zentrierteil zu Betoneinbauehäuse 332-2001, verzinktes Blech, nicht für Sichtbeton geeignet

Cover incl. centering for recessed housing for concrete 332-2001, made of zinc-plated sheet, not adapted for exposed concrete

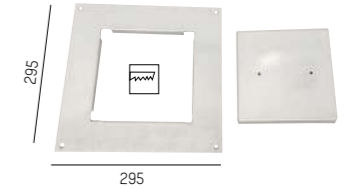

ABDECKUNG RUND / COVER ROUND

ABDECKUNG COVER	AUSSCHNITT CUTOUT	FÜR FOR
332-1402	Ø 80	DARK NIGHT SMALL R

Abdeckung inkl. Zentrierteil zu Betoneinbauehäuse 332-1001, verzinktes Blech, nicht für Sichtbeton geeignet

Cover incl. centering for recessed housing for concrete 332-1001, made of zinc-plated sheet, not adapted for exposed concrete

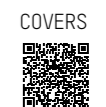
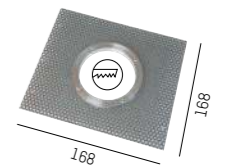

COVERS



HOUSING



more information

BIDO



Raiffeisenarena, Linz, Austria, Photo: Joachim Rauch



Glatzner, Lustenau, Austria, Photo: Joachim Rauch



Gusswerk, Salzburg, Austria, Photo: Joachim Rauch



Raiffeisen Arena, Linz, Austria, Photo: Joachim Rauch



Hartkaiserbahn, Elmau, Austria, Photo: Joachim Rauch



IBS Tower, Teufenbach, Austria, Photo: Joachim Rauch

BIDO



Zukunft.Coburg.Digital, Alte Kühlhalle, Coburg, Germany, Photo: Joachim Rauch

LIGHT IN SHAPES

Die aus Aluminium gefertigte Leuchtenserie BIDO besticht durch eine klare Formensprache. Eine runde sowie quadratische Version sind jeweils in 4 Größen erhältlich. Neben einer Einbauleuchte ist BIDO auch als Aufbau- und Hängeleuchte verfügbar, welche sowohl direkt als auch direkt/indirekt strahlend einsetzbar sind. BIDO ist ein stilvolles Element in der modernen Architektur und sowohl im gewerblichen Bereich als auch im privaten Wohnbereich vielfältig einsetzbar.



The BIDO lighting series, made in aluminium, is notable for its distinctive forms. It comes in both round and square versions, each in four different sizes. As well as a recessed luminaire, BIDO is available as a surface-mounted or pendant luminaire, which can be used for direct or indirect lighting. BIDO is a stylish element in modern architecture and has a wide range of uses in commercial spaces as well as in the home.

Design: INHOUSE

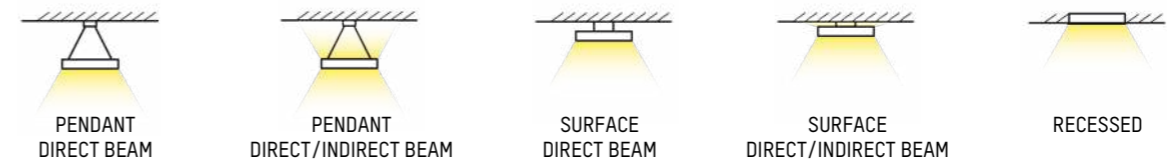
VARIATIONS



FORM & SIZES

 square 300 x 300mm / 940 - 3180lm 400 x 400mm / 1870 - 6360lm 600 x 600mm / 3750 - 12740lm 900 x 900mm / 9370 - 22950lm	 circle Ø 300mm / 700 - 2550lm Ø 400mm / 1410 - 5110lm Ø 600mm / 3280 - 11470lm Ø 900mm / 7500 - 19160lm
--	--

LED COLOURS

 2700K	 3000K	 4000K
--	--	--

CORE COLOURS

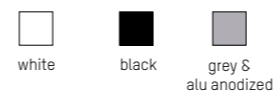

CREATIVE COLOURS

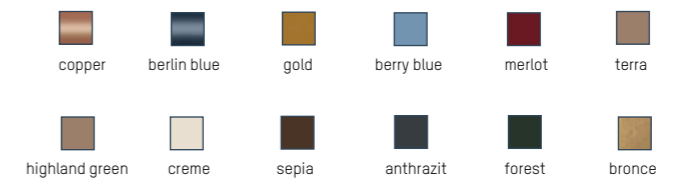

COVER OPTIONS

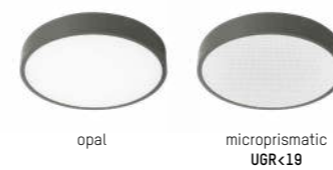

SPECIALS





60% FASTER MOUNTING

BIDO SD/SDI wurde so konzipiert, dass die Montage ohne großen Aufwand und in Rekordzeit erfolgt. Mit unserem innovativen EASY MOUNTING SYSTEM wird die Installation um ca. 60% schneller und einfacher als bei marktüblichen Aufbaufächenleuchten. Damit sparen Sie nicht nur wertvolle Zeit, sondern auch Installationskosten.

BIDO SD/SDI has been designed to be mounted effortlessly and in record time. Thanks to our innovative EASY MOUNTING SYSTEM, installation is approximately 60% faster and easier than with commercially available surface-mounted panel lights. This not only saves you valuable time but also reduces the cost of installation.

BIDO SDI/SD

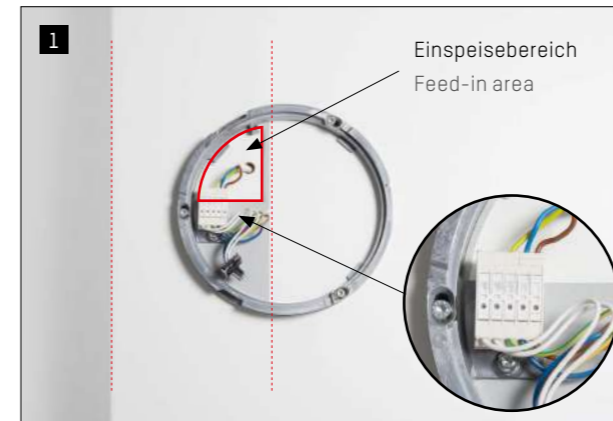

1 Befestigungsring montieren und verkabeln; quadratische Version parallel zur Wand ausrichten (siehe Linie)
Mount the fastening ring and wire it; align the square version parallel to the wall (see line)

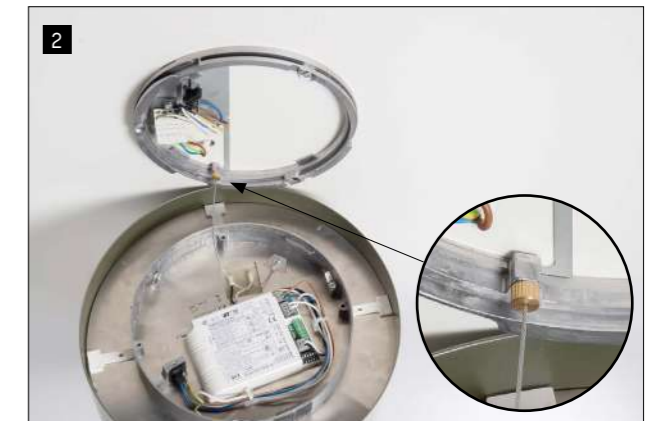

2 Absturzsicherung mit Schraube befestigen
Fasten the fall protection with the screw



3 Leuchte so ansetzen, dass die Bajonettteile des Befestigungsringes und der Leuchte übereinstimmen
Place the luminaire in a way that the bayonet parts of the fastening ring and the luminaire match up



4 Leuchte drehen bis Bajonettverschluss einrastet und die Steckverbindung im Inneren verbunden ist
Turn the luminaire until the bayonet catch engages and the plug connection inside is connected



5 Netzspannung einschalten
Switch on the voltage



MONTAGEVIDEO
MOUNTING VIDEO



50% FASTER MOUNTING

BIDO R wurde so konzipiert, dass die Montage ohne großen Aufwand und in Rekordzeit erfolgt. Mit unserem innovativen EASY MOUNTING SYSTEM wird die Installation um ca. 50% schneller und einfacher als bei marktüblichen Einbaufächenleuchten. Damit sparen Sie nicht nur wertvolle Zeit, sondern auch Installationskosten.

BIDO R has been designed to be mounted effortlessly and in record time. Thanks to our innovative EASY MOUNTING SYSTEM, installation is approximately 50% faster and easier than with commercially available recessed panel lights. This not only saves you valuable time but also reduces the cost of installation.

BIDO R

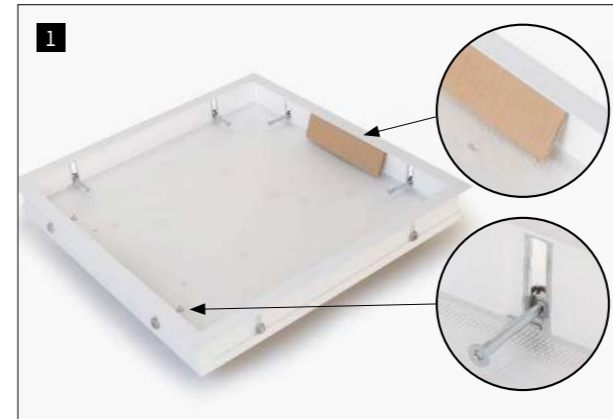

1
Schrauben nur bis zum Ende des ersten Gewindes eindrehen; Montagehilfe (Karton) einsetzen
Insert the screws only as far as the end of the first thread; insert the assembly aid (cardboard)



2
Leuchte anschließen und in Deckenausschnitt einsetzen (Konverter ist im Gehäuse verbaut)
Connect luminaire and mount into ceiling cut-out (converter is built into housing)



3
Schrauben an den Deckenrand senken, bis zum zweiten Gewinde einschieben und festschrauben
Lower the screws to the edge of the ceiling, insert them up to the second thread and screw them tight



4
Ansicht von oben
Top view

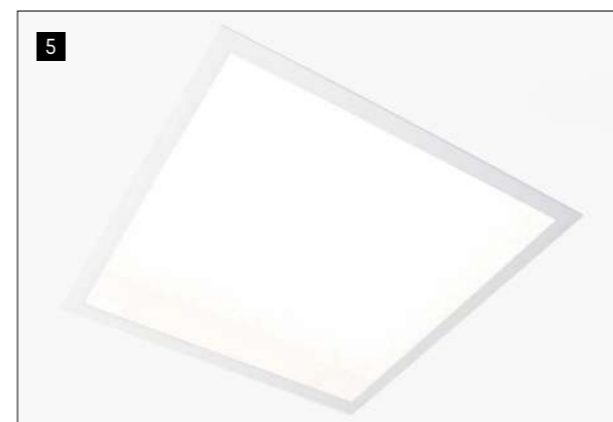

5
Montagehilfe (Karton) entfernen und die Abdeckung nach unten senken; Netzspannung einschalten
Remove the assembly aid (cardboard) and let the cover slide down; switch on the voltage



MONTAGEVIDEO
MOUNTING VIDEO



Raiffeisen Arena, Linz, Austria, Photo: Joachim Rauch

BIDO CONFIGURATOR

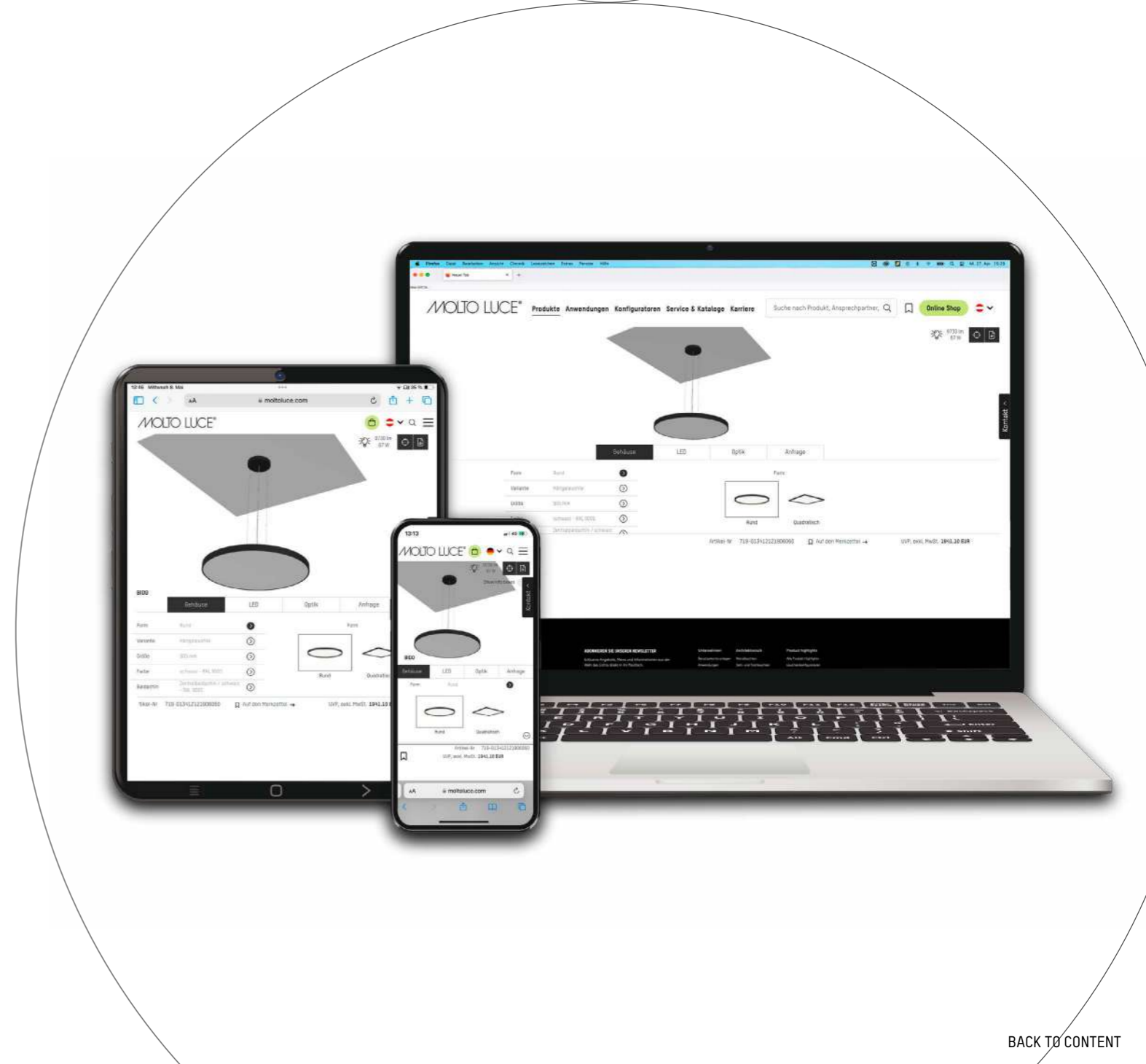

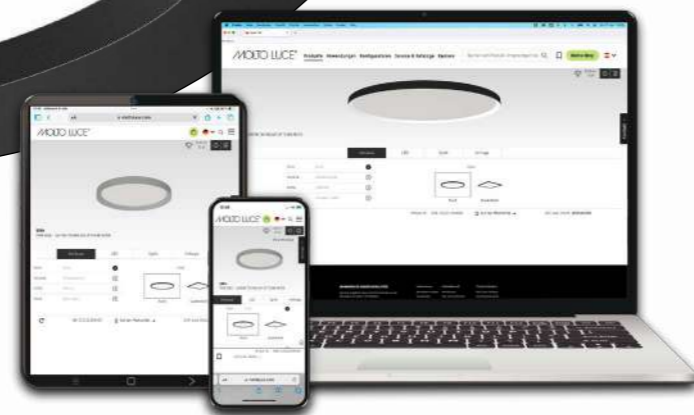

configurable

BINA



Tischlerei Berger, Ratten, Austria, Photo: Joachim Rauch



WE-Electric, Bad Leonfelden, Austria, Photo: Joachim Rauch



BMD Business Solutions, Steyr, Austria, Photo: Joachim Rauch



N'Cyan – Innovation für Menschen, St. Jakob in Deferegggen, Austria, Photo: Joachim Rauch



MSG Naturenergie, Hohenau, Germany, Photo: Joachim Rauch



Hotel Vivo Ademaj, Schierling, Germany, Photo: Joachim Rauch

BINA



INNOVATIVE LIGHTING TECHNOLOGY, EXTRA-SLIM DESIGN

Modernste Edge-Lighting Technology durch speziell entwickelte Lichtleiterplatten vereint sich mit klarer Formensprache und schlankem Design zu einer variantenreichen Leuchtenfamilie. Die Produktfamilie ist als Baukastensystem konzipiert, sodass die Leuchten perfekt auf das Projekt abgestimmt werden können. Ein schräg nach innen verlaufender Dekorring vervollständigt das ansprechende Design. Die Vielfältigkeit schafft Abwechslung in der Raumgestaltung und ermöglicht ein spannendes Lichtkonzept innerhalb eines Projektes.

The latest Edge-Lighting technology with specially developed light guide plates creates a clear style and a slim-line design. The product family is designed as a modular system so that the luminaires can perfectly be tailored to the demands of a particular project. An obliquely inward decorative ring completes the particularly appealing design. The rich variety offers a huge degree of flexibility within a given space and provides scope for an exciting lighting concept within a project.

Design: INHOUSE

VARIATIONS

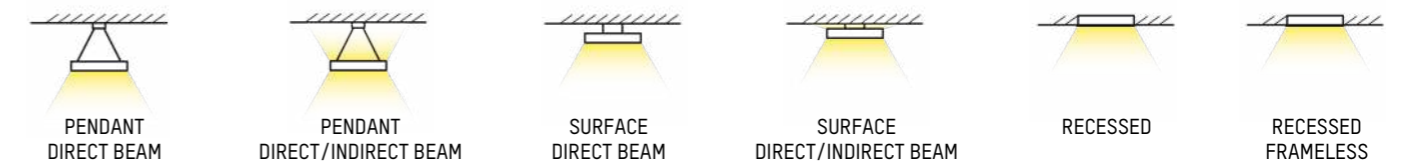

FORM & SIZES

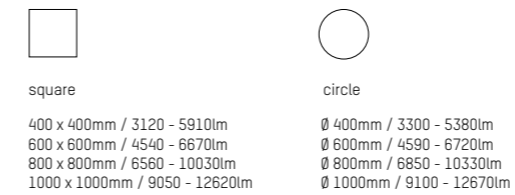

LED COLOURS



CORE COLOURS

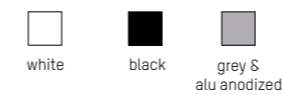

CREATIVE COLOURS

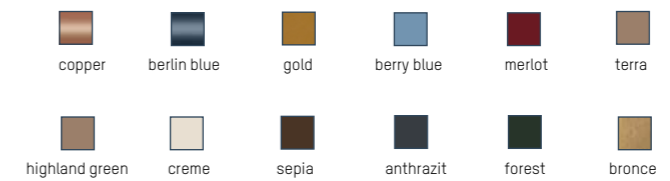

COVER OPTIONS



Tür 91 Pieno
Vienna, Austria
Photo: Joachim Rauch



more information



COLOUR YOUR *LIGHT*

Die Leuchtenserie BINA bietet eine Vielzahl von Farboptionen, darunter Weiß, Schwarz, Grau und Creative Colours wie zum Beispiel Merlot, Highlandgreen oder Gold. Die verschiedenen Farbkombinationen ermöglichen es Ihnen, das Design der Leuchte an Ihre individuellen Gegebenheiten anzupassen.

The BINA luminaire range offers a variety of colour options, including white, black, grey and creative colours such as merlot, highland green or gold. The different colour combinations allow you to adapt the design of the luminaire to your individual preferences.

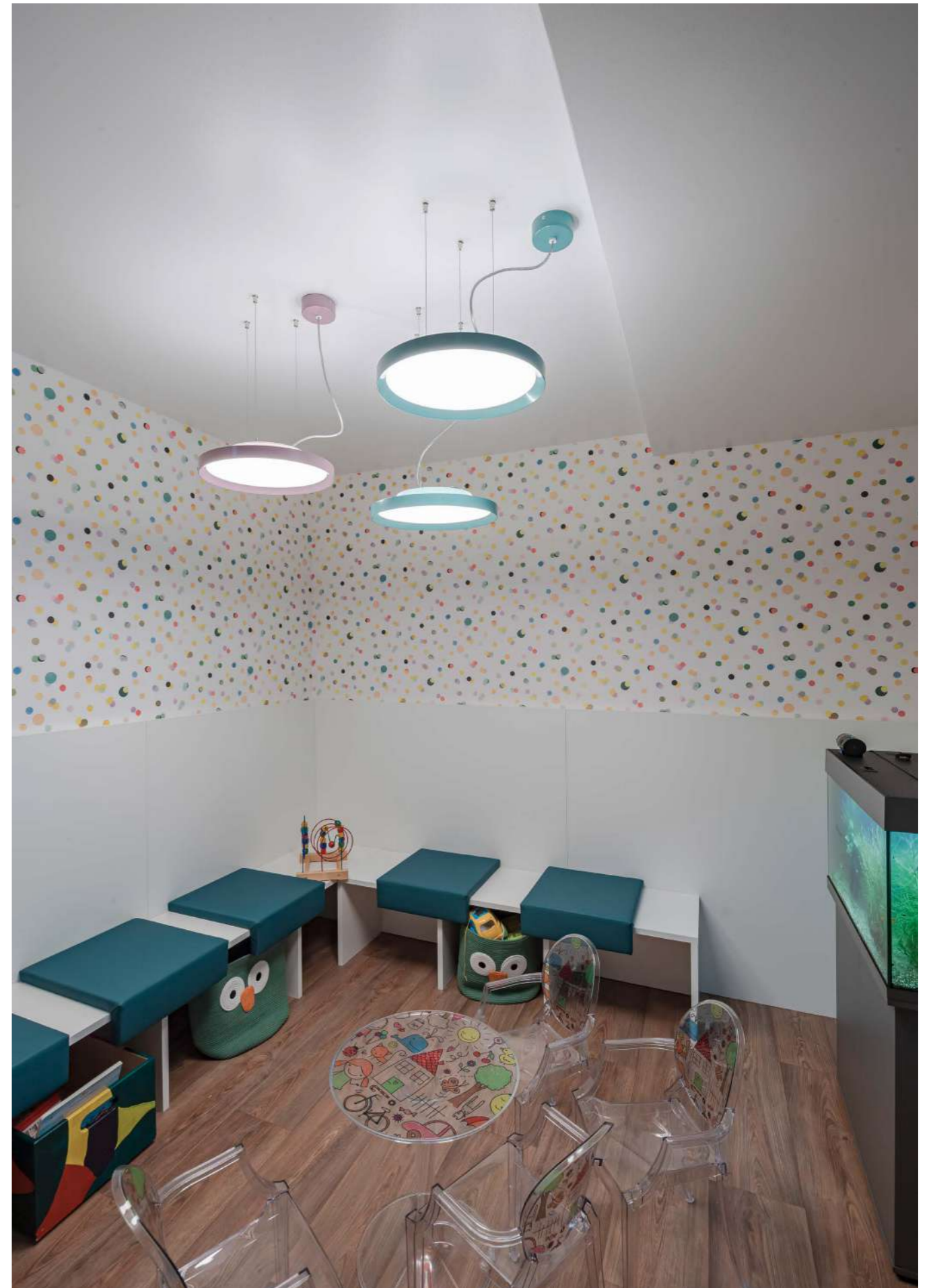

Dr. Kretz, Gmunden, Austria, Photo: Joachim Rauch



Office Project,, Kufstein, Austria, Photo: Joachim Rauch

BINA CONFIGURATOR

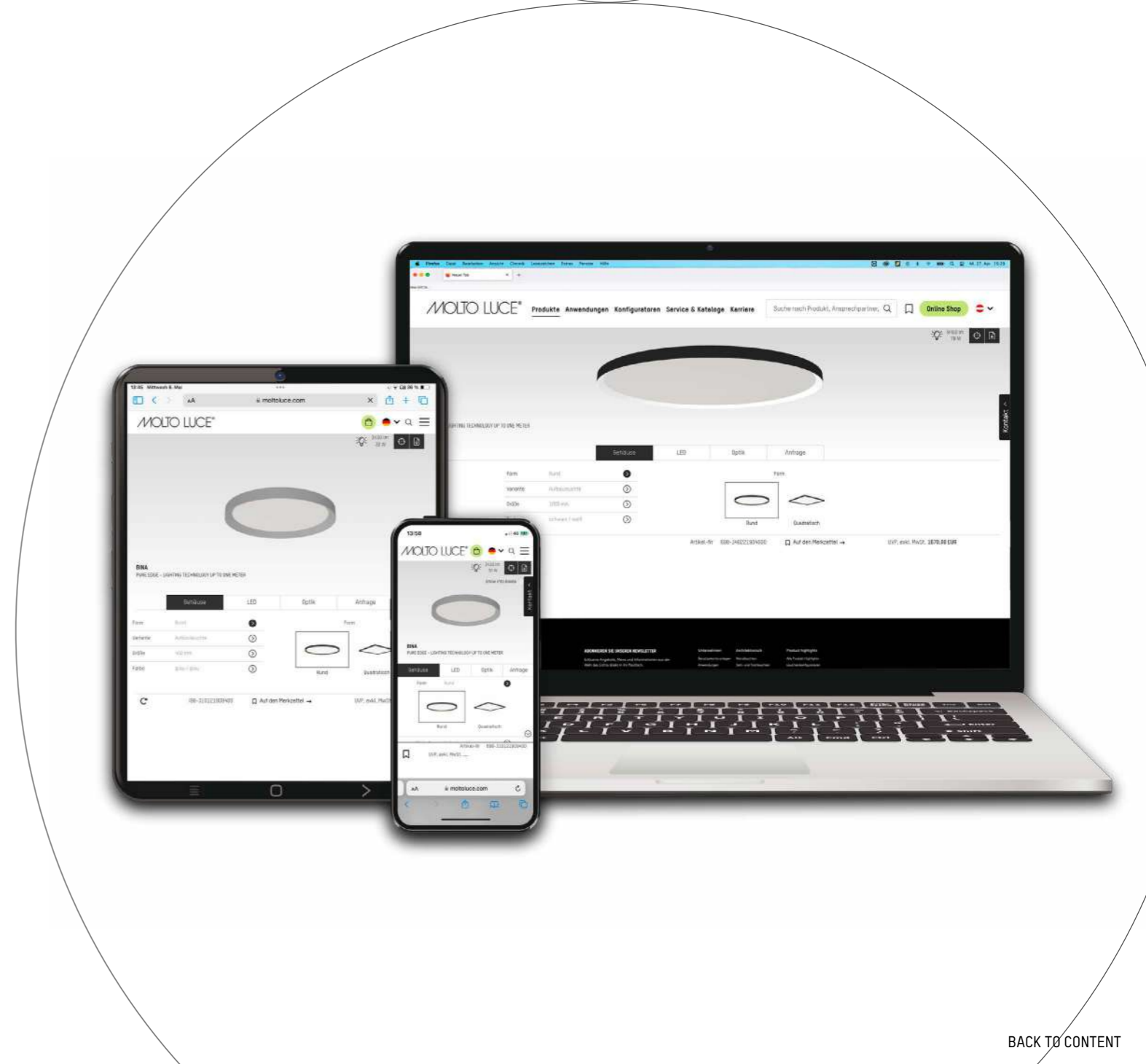
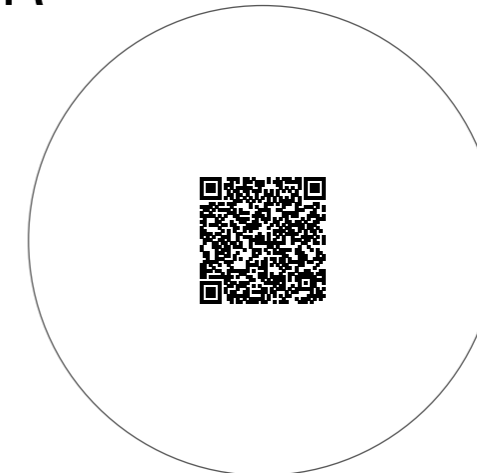



TURN ON 2

ROUND VARIETY

Die TURN ON Familie ist in 4 verschiedenen Größen und als Pendel- Deckenaufbau- oder Wandleuchte verfügbar. Die flache Leuchtenhöhe von nur 6cm wird durch einen LGP-Diffusor (Light Guide Plate) möglich. Die Lichtquelle sitzt dabei am Rand der Leuchte und bewirkt so eine sehr homogene und sanfte Ausleuchtung. Die unterschiedlichen Varianten von TURN ON schaffen eine perfekte Lichtwirkung. Gehäuse und Dekorring können farblich individuell angepasst werden.

The TURN ON family is available in four different sizes and as a pendant, surface-mounted or wall-mounted luminaire. The slim depth of only 6cm is enabled by an LGP diffuser (Light Guide Plate). This allows the light source to sit at the edge of the luminaire, effecting a very homogeneous and soft illumination. The different variants of TURN ON create a perfect lighting effect. The colour of the cover and decorative ring can be customised to your wishes.

Design: INHOUSE

VARIATIONS



FORM & SIZE

Ø 110mm LM: 420 - 570	Ø 150mm LM: 770 - 1000	Ø 300mm LM: 1080 - 1340	Ø 450mm LM: 2440 - 4610

CORE COLOURS



CREATIVE COLOURS

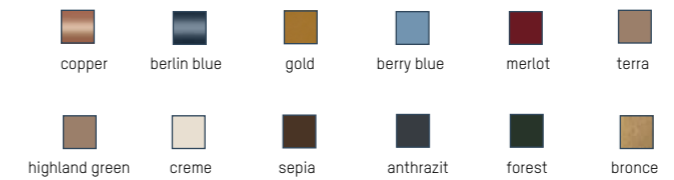

LED COLOURS



SPECIALS

**DIM2
WARM**
dim2warm only for
Ø 150, 300 & 450 and DALI versions



Office Project, Kufstein, Austria, Photo: Joachim Rauch

TURN ON 2 DIM TO WARM



3000K

2200K

Turn On 2 mit Dim to Warm Funktion ermöglicht es, die Lichtfarbe und die Helligkeit anzupassen, indem sie von einer helleren, kühleren Farbtemperatur zu einem warmen und gemütlichen Licht wechselt, während sie dabei gleichzeitig gedimmt wird. Diese Funktion schafft eine angenehme Atmosphäre und kann je nach Bedarf für verschiedene Aktivitäten oder Stimmungen angepasst werden.

Turn On 2 with Dim to Warm function allows you to adjust the light color and brightness by transitioning from a brighter, cooler colour temperature to a warm and cozy light while simultaneously dimming. This function creates a pleasant atmosphere and can be adjusted for different activities or moods as needed.



TURN ON 2

TURN ON 2 PD / PDI

220-240V AC

50/60Hz

Design: INHOUSE

IP20 

LED Pendelleuchte aus Aluminium · Oberfläche pulverbeschichtet · in unterschiedlichen Farben erhältlich · schaltbar oder DALI dimmbar
 LED pendant in aluminium · surface powder-coated · available in different colours · switchable or DALI dimmable
 Sospensione LED in alluminio · superficie verniciata a polvere · disponibile in diversi colori · on/off o dimmerabile DALI
 Suspension LED en aluminium · surface thermolaquée · disponible en différentes couleurs · on/off ou dimmable DALI

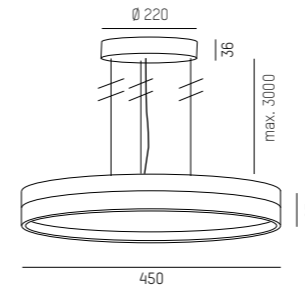

configurable



Raiffeisen Arena, Linz, Austria, Photo: Joachim Rauch

TURN ON 2

TURN ON 2 SD

220-240V AC

50/60Hz

Design: INHOUSE

IP20 

LED Deckenaufbauleuchte aus Aluminium · Oberfläche pulverbeschichtet · in unterschiedlichen Farben erhältlich · schaltbar oder DALI dimmbar
 LED surface mounted ceiling luminaire in aluminium · surface powder-coated · available in different colours · switchable or DALI dimmable
 Lampada a plafone in alluminio · superficie verniciata a polvere · disponibile in diversi colori · on off o dimmerabile DALI
 Plafonnier LED en aluminium · surface thermolaquée · disponible en différentes couleurs · on/off ou dimmable DALI

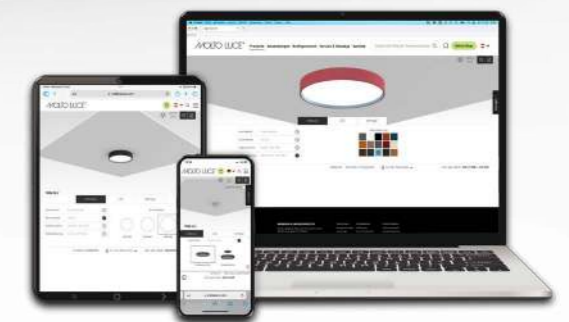
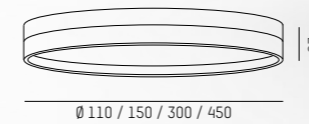

configurable

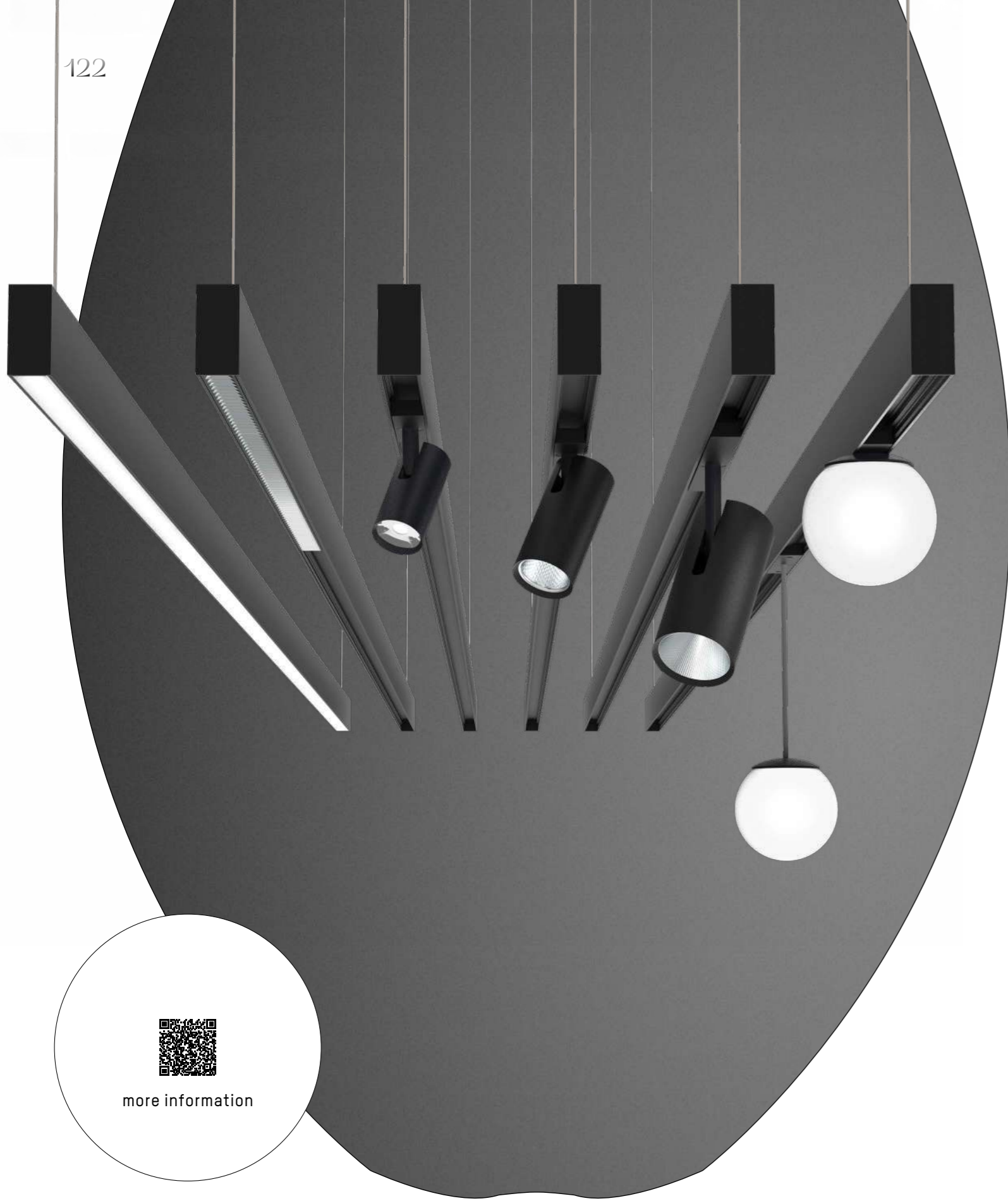

MAGNETICS

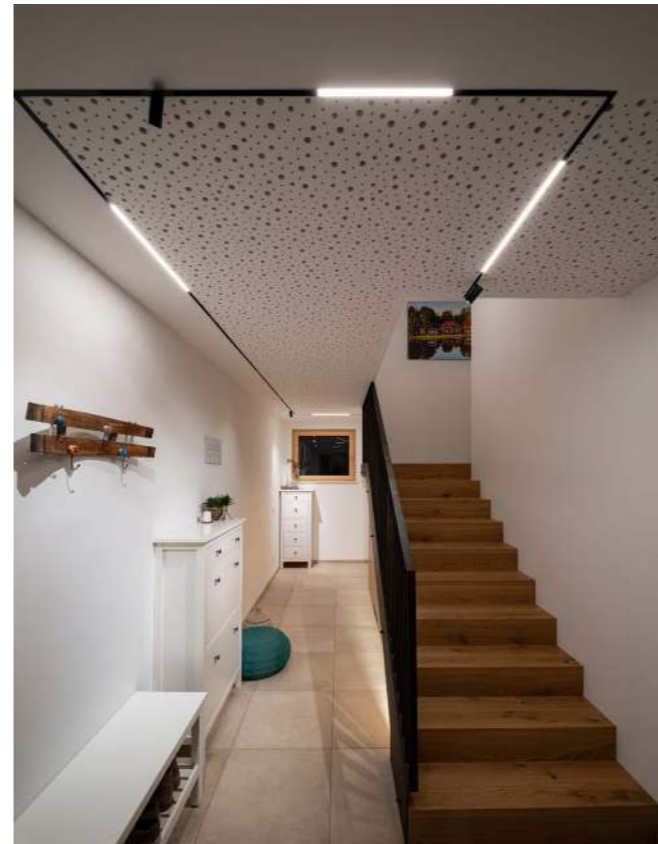

Private residence, Austria, Photo: Joachim Rauch

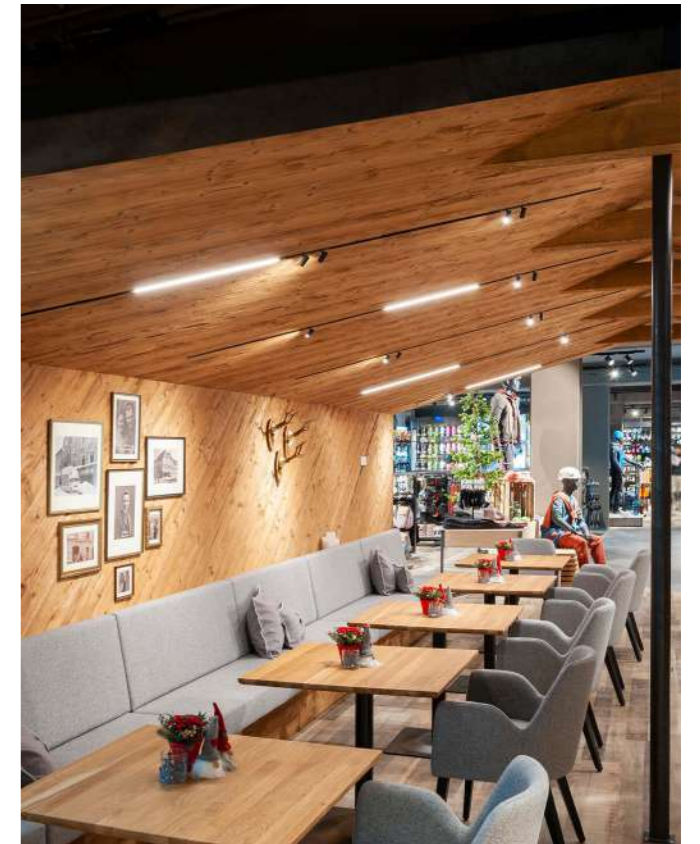

Intersport Tscherne, Salzburg, Austria, Photo: Joachim Rauch



Unykat showroom, Salzburg, Austria, Photo: Joachim Rauch

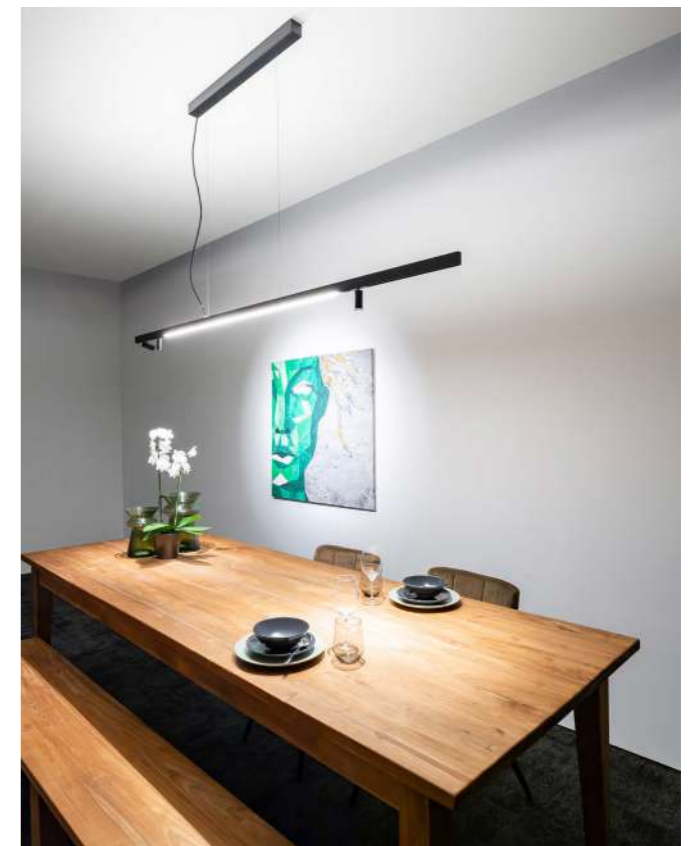

Molto Luce showroom, Wels, Austria, Photo: Joachim Rauch



Light & Building 2024
Frankfurt, Germany
Photo: Joachim Rauch

MAGNETICS

MAXIMUM FLEXIBILITY – MINIMALIST DESIGN

Versetzen oder einfach nur den Strahlerkopf verstellen, die einfache Magnetbefestigung ermöglicht ein schnelles Umgestalten der Komponenten. Zudem sind alle Lichteinsätze verpolungssicher und können bequem auch beidseitig in die Schiene eingesetzt werden. Diverse Lichteinsätze in unterschiedlichen Längen, sowie die Strahler in vier Größen, bieten eine absolut flächenbündig in der Schiene sitzende lineare Grundbeleuchtung mit Akzentuierung. Nur ein Handgriff und jedes beliebige Objekt ist perfekt in Szene gesetzt.

Move or simply adjust the spotlight head, the simple magnetic fixture ensures fast rearrangement of the components. On top of that, all luminaire inputs are protected against wrong polarity and can be easily inserted on both sides of the rail. Various light inserts of different lengths as well as spotlights in four sizes offer a linear basic lighting which is absolutely flush with the rail and sets accents. Draw attention to any object with a flick of the wrist.

Design: INHOUSE

VARIATIONS

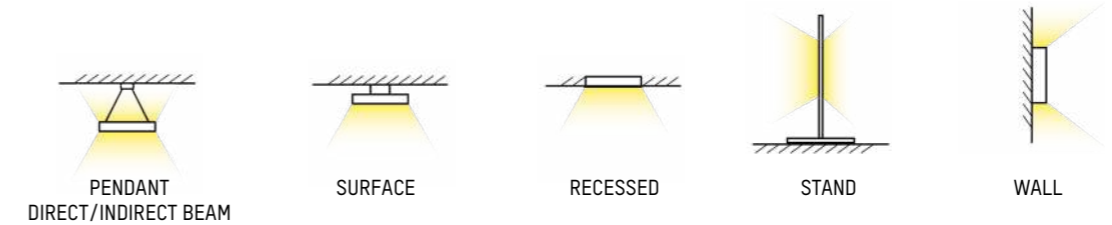

PROFILES



FORM



LED COLOURS



SYSTEM INSERTS



SPECIALS



Spotlight head in creative colour

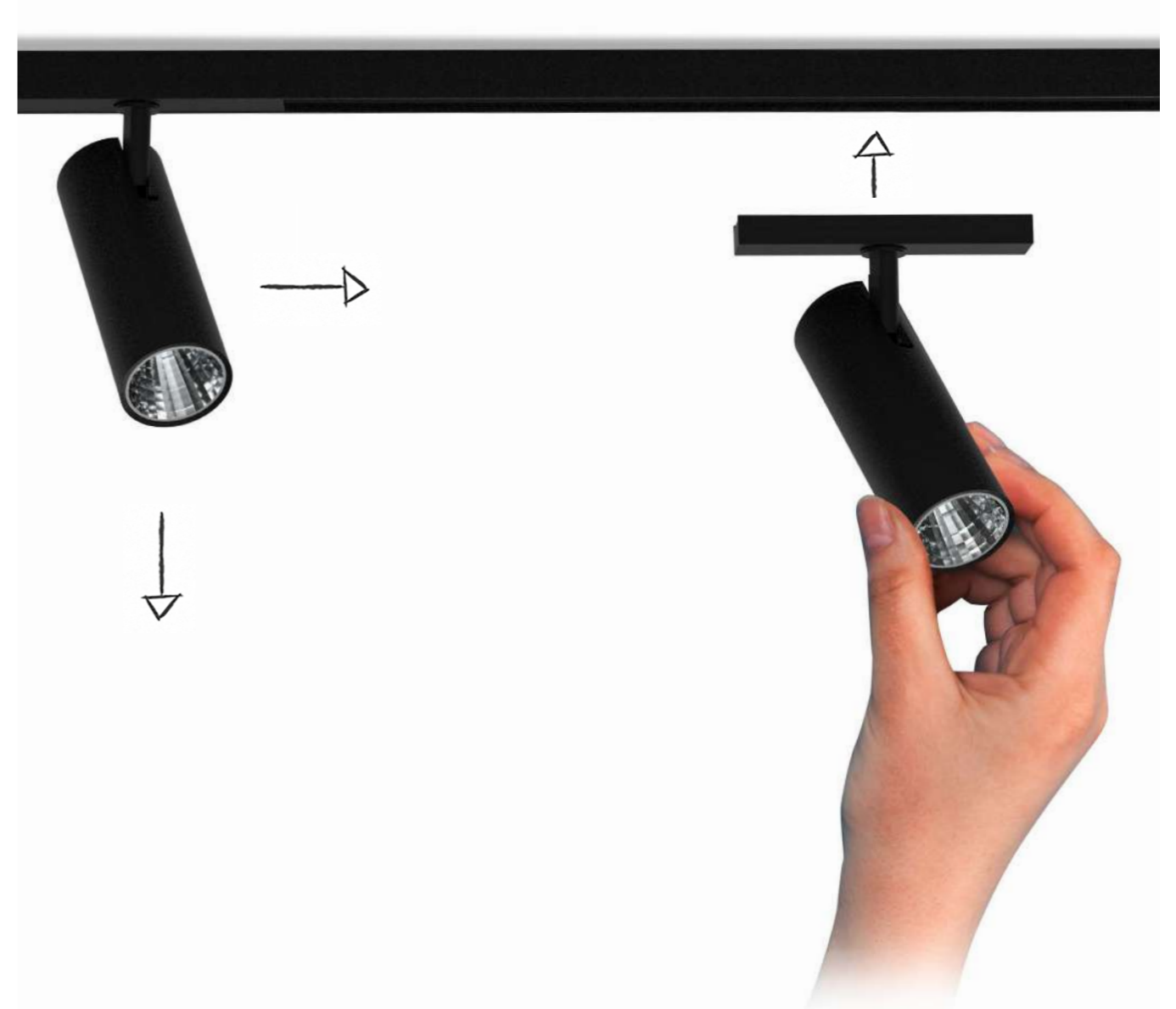
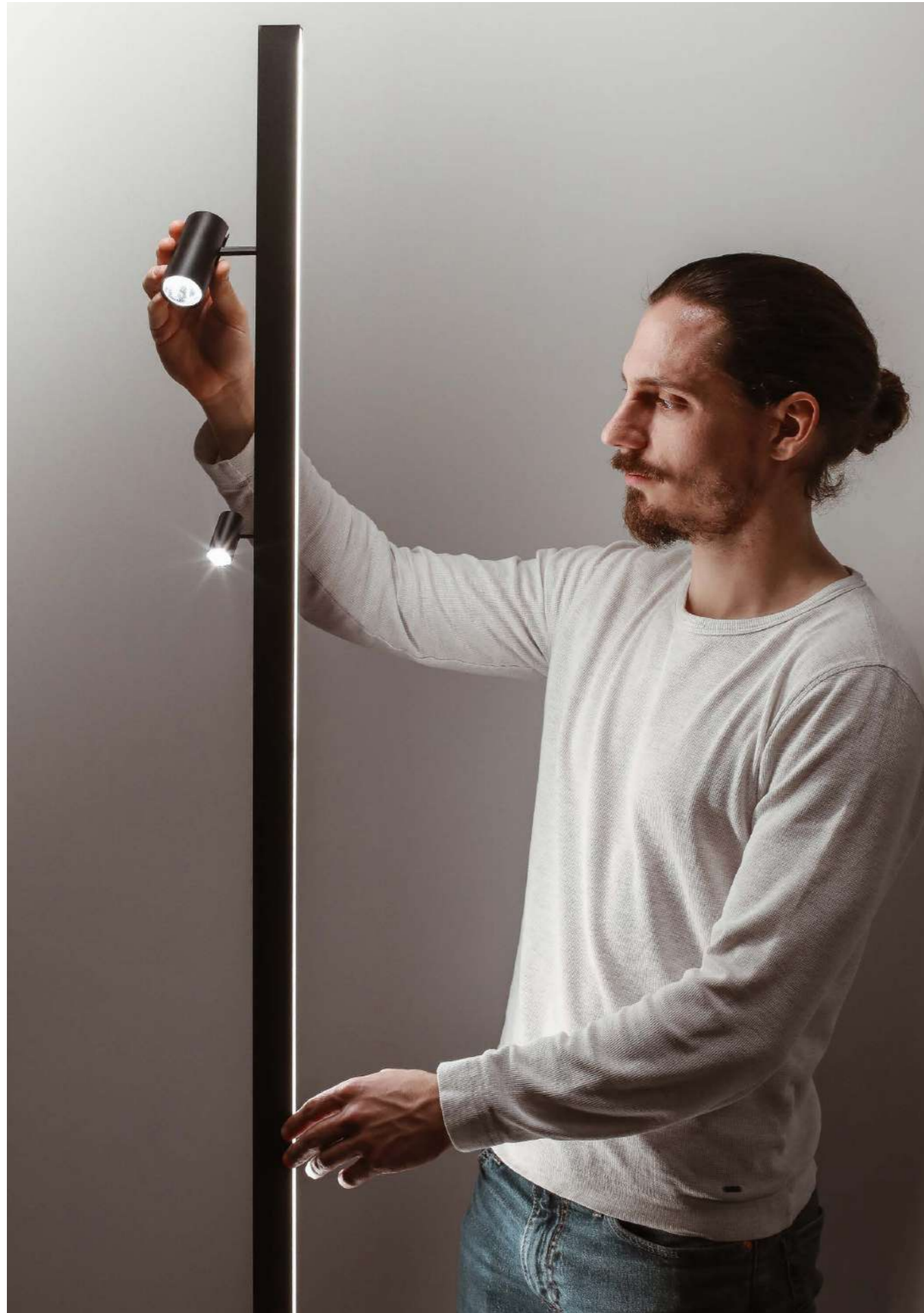

EASY-TO-REPLACE INSERTS

Versetzen oder einfach nur den Strahlerkopf verstellen. MAGNETICS lässt sich mit Hilfe von magnetischer Befestigung in kürzester Zeit an neue Bedingungen anpassen.

With magnetic fastening, simply move or adjust the spotlight head - MAGNETICS can be adapted to new scenarios in no time at all.

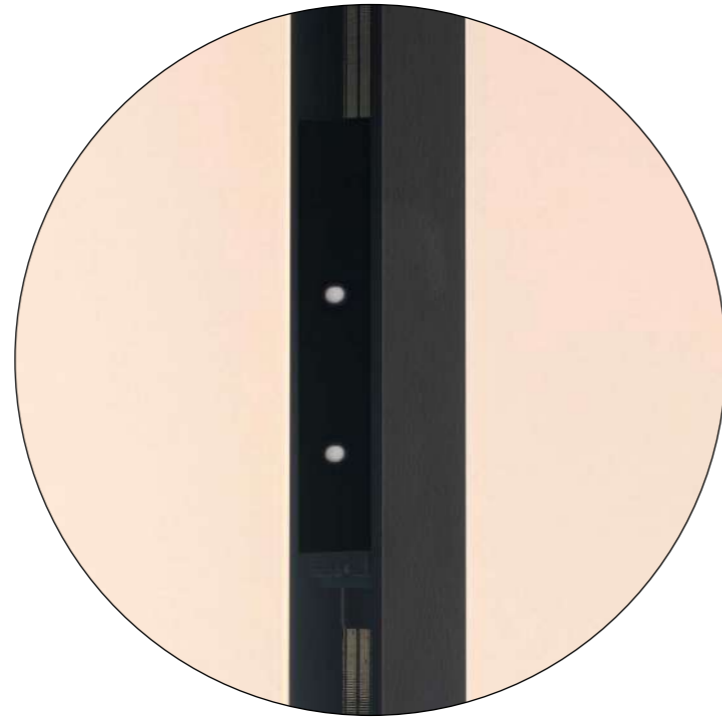

MAGNETICS CONTROLLER

An jeder Stelle des Profils durch Magnetsystem einsetzbar, 2 Gruppen Stand Alone Lösung für max. 20 DALI Betriebsgeräte, frei programmier- und steuerbare Aufteilung der DALI Betriebsgeräte auf 2 Gruppen, keine DALI Infrastruktur erforderlich, inkl. Busversorgung und Status LED je Gruppe, aus PMMA, schwarz satiniert, IP20

Can be placed in any position along the profile thanks to the magnetic system, 2 groups stand-alone solution for max. 20 DALI control gear units, freely programmable and controllable division of DALI control gear units into 2 groups, no DALI infrastructure required, incl. bus supply and status LED per group, made of PMMA, black satin finish, IP20

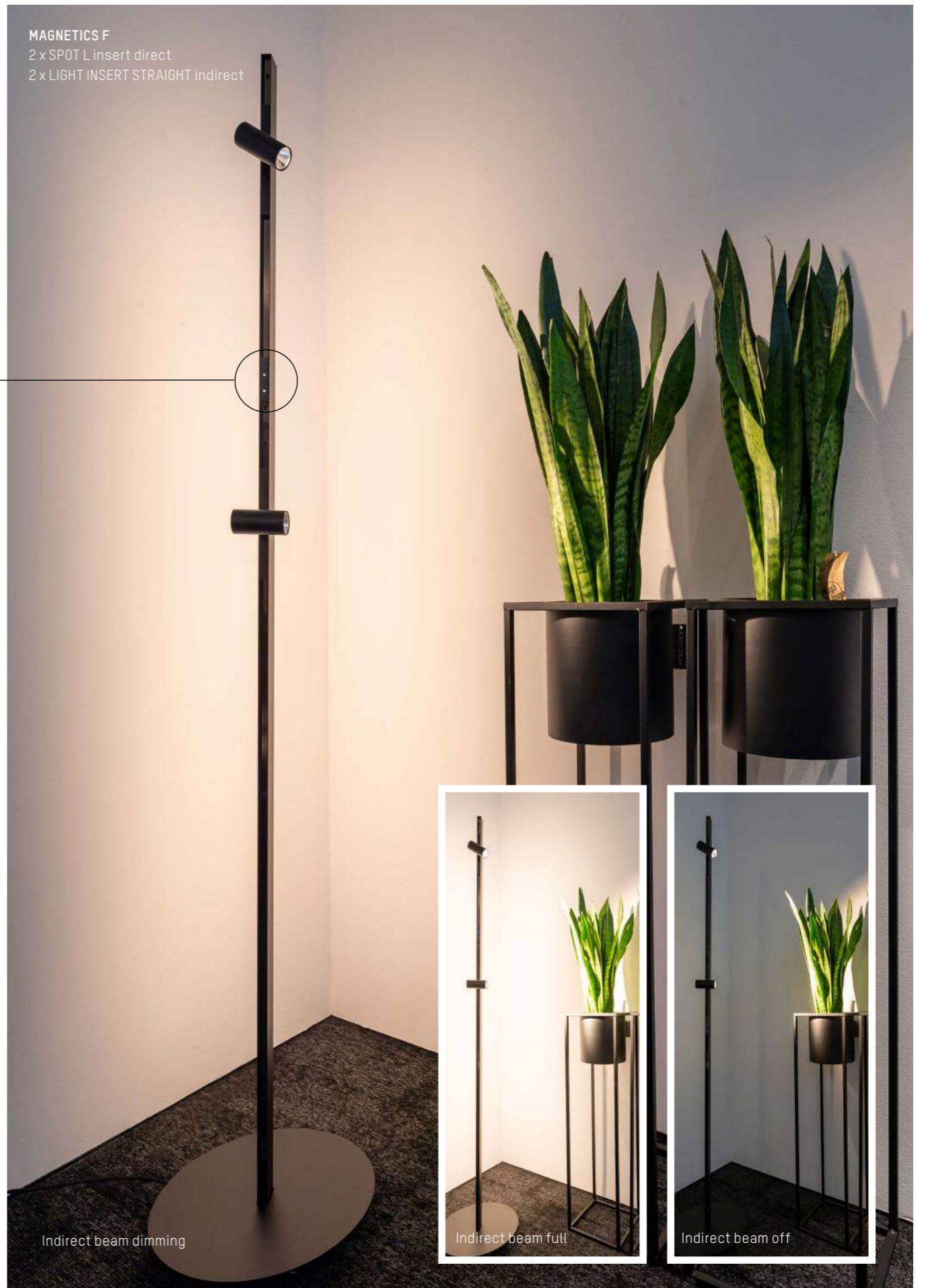



Studio 963, Mühlbach, Austria, Photo: Studio 963



Studio 963, Mühlbach, Austria, Photo: Studio 963

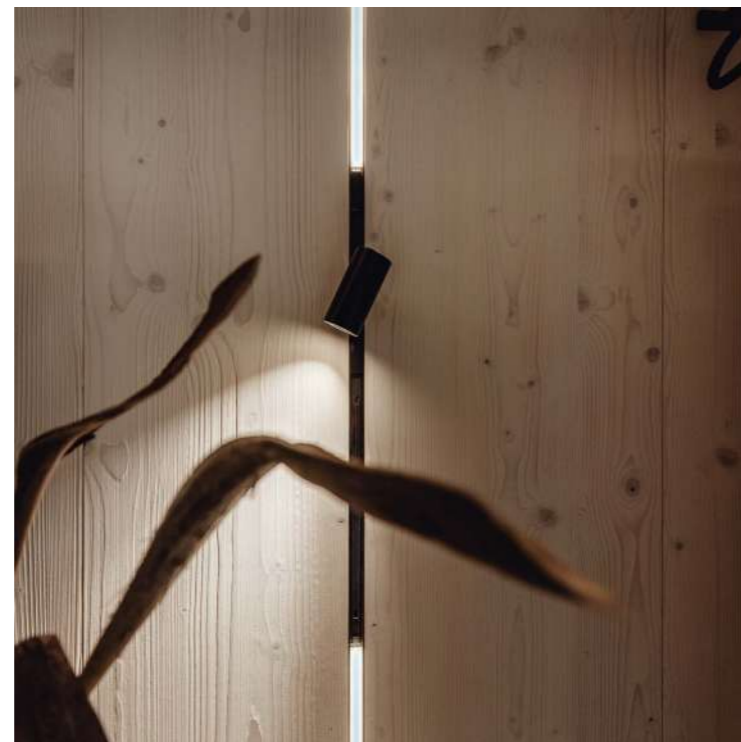

Studio 963, Mühlbach, Austria, Photo: Studio 963



Studio 963, Mühlbach, Austria, Photo: Studio 963



MAGNETICS PDI | direct / indirect beam | opal insert | 3 x SPOT M insert



MAGNETICS PDI | direct / indirect beam | grid insert | 2 x SPOT M insert

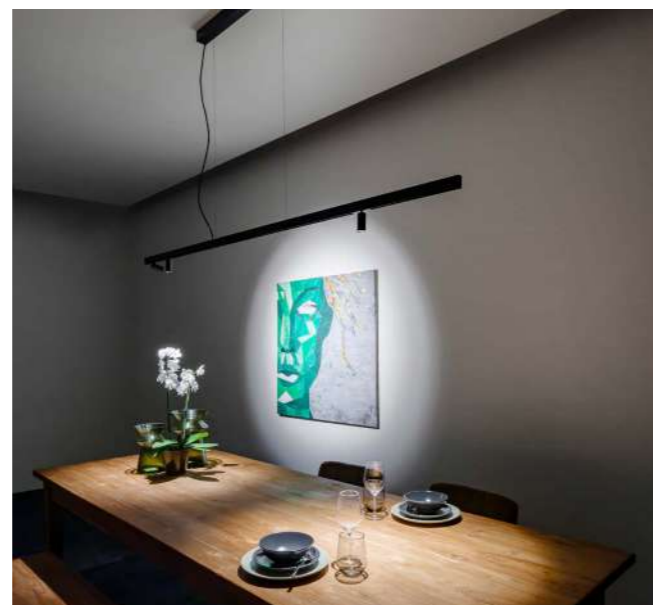

MAGNETICS PDI | direct beam | 3 x SPOT M insert

MAGNETICS H PDI

MAGNETICS H PDI

24V DC 50/60Hz Design: INHOUSE

Pendelleuchte aus Aluminiumprofil · Oberfläche schwarz · Direkt- / Indirekt Trackplatine · Lichteinsätze separat ordern
 Pendant luminaire made of aluminium profile · black surface · direct/indirect track circuit board · light inserts to be ordered separately
 Lampada a sospensione in alluminio · finitura nera · scheda di circuito diretta ed indiretta · inserti luminosi da ordinare separatamente
 Suspension en aluminium · finition noire · circuit imprimé direct et indirect · inserts lumineux à commander séparément

TRACK

CODE	L mm	LUMEN
708-0101600006d	1403	460 - 520
708-0101700006d	2003	690 - 780

inkl. DALI Repeater
 Lichteinsätze separat ordern (S. 148-155)
 incl. DALI repeater
 order light inserts sepately (p. 148-155)

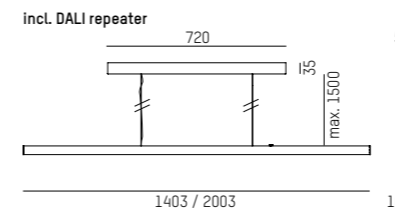

TRACK

CODE	L mm	LUMEN
708-0101800006d	1403	460 - 520
708-0101900006d	2003	690 - 780

exkl. DALI Repeater
 Lichteinsätze separat ordern (S. 148-155)
 excl. DALI repeater
 order light inserts sepately (p. 148-155)

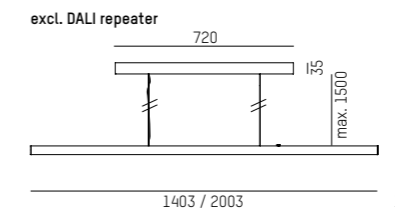

INDIRECT BEAM

DIRECT BEAM

CODE	SYS W	L mm	LUMEN
708-0102010WW06Y	18	1403	2438
708-0102110WW06Y	26	2003	3498

inkl. lineare Lichteinsätze opal
 incl. linear light inserts

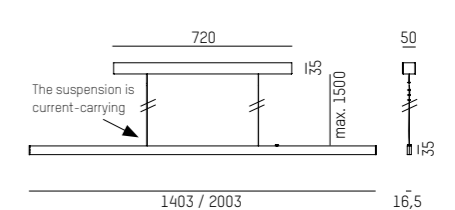

COMPLETE CODE	
WW = LIGHT COLOUR	Y = DIMMABLE
W2 LED 2700K = 23 CRI>90	Ⓢ switchable = 0
W3 LED 3000K = 29 CRI>90	Ⓣ DALI dimm. = d
W4 LED 4000K = 24 CRI>90	

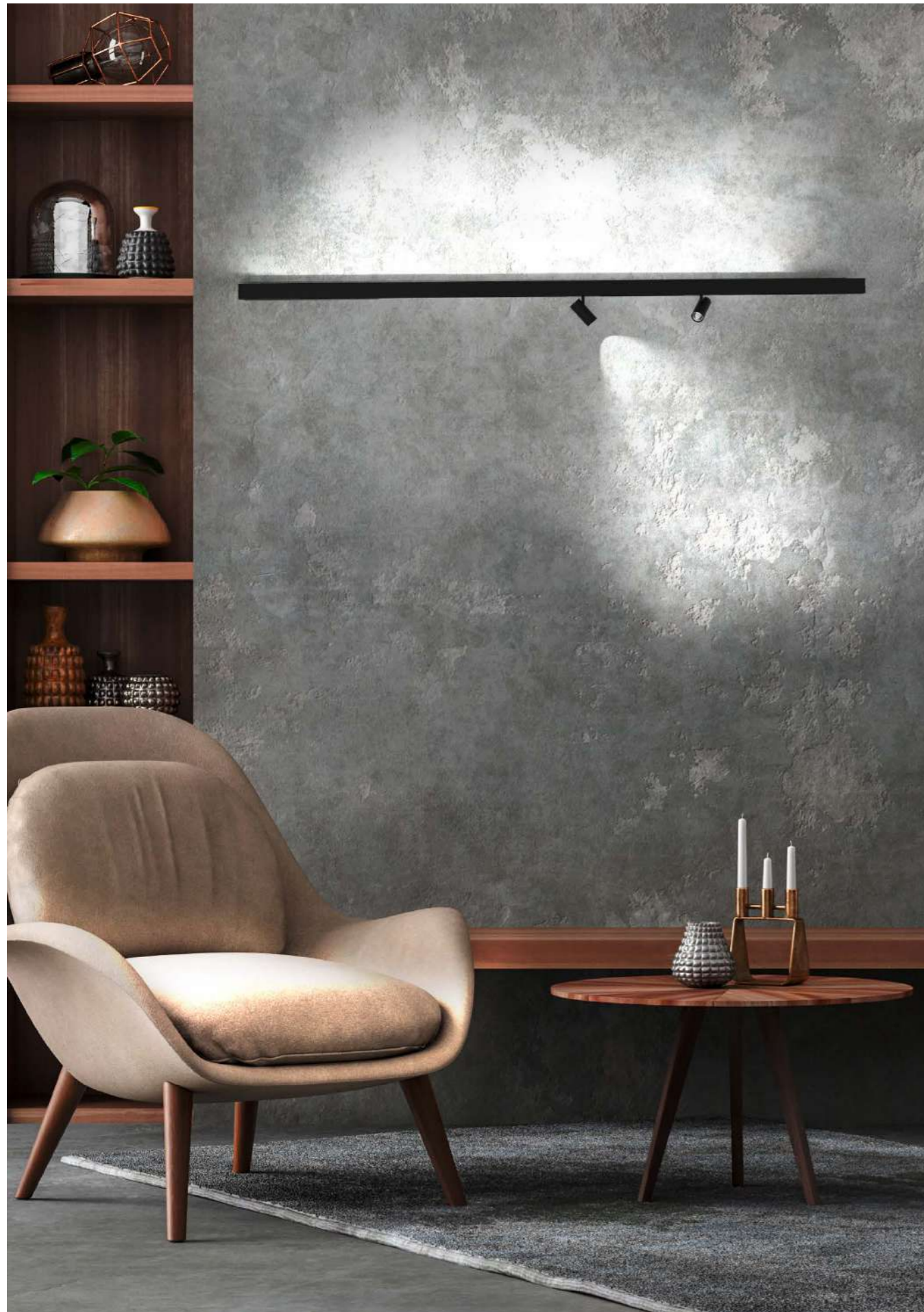

MAGNETICS H W

MAGNETICS H W

24V DC 50/60Hz Design: INHOUSE

Wandleuchte aus Aluminiumprofil · Oberfläche schwarz · ohne DALI Repeater · Lichteinsätze separat ordern
 Wall luminaire made of aluminium profile · black surface · without DALI repeater · order light inserts separately
 Lampada a parete in alluminio · finitura nera · senza DALI ripetitore · inserti luminosi da ordinare separatamente
 Applique en aluminium · finition noire · sans DALI répéteur · inserts lumineux à commander séparément

TRACK

CODE	L mm
708-00909000006d	1403
708-00910000006d	2003

Lichteinsätze separat ordern (S. 148-155)
 order light inserts sepately (p. 148-155)

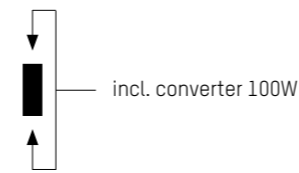
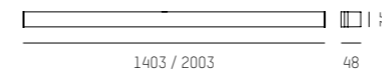

INDIRECT BEAM DIRECT TRACK

CODE	SYS W	L mm	LUMEN
708-0091200WW06d	18	1403	1219
708-0091300WW06d	26	2003	1749

Lichteinsätze separat ordern (S. 148-155)
 order light inserts sepately (p. 148-155)

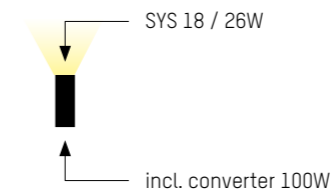

INDIRECT BEAM DIRECT BEAM

CODE	SYS W	L mm	LUMEN
708-0091400WW06Y	36	1403	2438
708-0091500WW06Y	52	2003	3498

inkl. lineare Lichteinsätze opal
 incl. linear light inserts

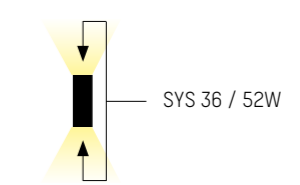

COMPLETE CODE

WW = LIGHT COLOUR

W2	LED 2700K = 23 CRI>90
W3	LED 3000K = 29 CRI>90
W4	LED 4000K = 24 CRI>90

Y = DIMMABLE

S	switchable = 0
D	DALI dimm. = d



MAGNETICS H F

MAGNETICS H F

24V DC

50/60Hz

Design: INHOUSE

Stehleuchte aus Aluminiumprofil · Oberfläche schwarz · direkt-/ indirekt strahlend · Lichteinsätze direktstrahlend separat ordern

Floor luminaire made of aluminium profile · black surface · direct/indirect distribution · light inserts direct distribution to be ordered separately

Lampada da terra in alluminio · finitura nera · illuminazione diretta ed indiretta · inserti luminosi per illuminazione diretta da ordinare separatamente

Lampadaire en aluminium · finition noire · éclairage direct et indirect · inserts lumineux pour l'éclairage direct à commander séparément

DIRECT TRACK  INDIRECT BEAM 

CODE	SYS W	H mm	LUMEN
708-0120610WW06d	24	1898	1590

Lichteinsätze separat ordern (S. 148-155)
order light inserts separately (p. 148-155)

TASTER DARK

708-00003000006d

Zum dimmen und EIN/AUS an der Leuchte
Direkt-/ indirekt getrennt schaltbar bzw. dimmbar
for dimming an ON/OFF on the luminaire
direct-/ indirect separate switchable or dimmable

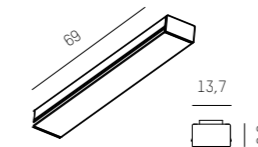
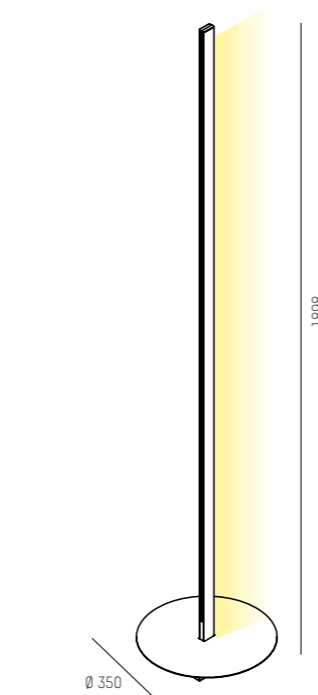

SYS 24W →  ← incl. converter 60W



COMPLETE CODE

WW = LIGHT COLOUR

W2	LED 2700K = 23	CRI>90
W3	LED 3000K = 29	CRI>90
W4	LED 4000K = 24	CRI>90



MAGNETICS PROFIL
MAGNETICS PROFILE
L: 300 - 2400mm

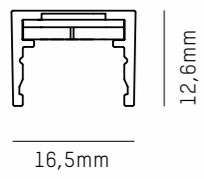

SYSTEM AUFBAU ODER EINBAUMONTAGE
SYSTEM SURFACE OR RECESSED MOUNTING
DIREKT STRAHLEND
DIRECT LIGHT BEAM

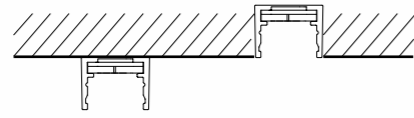

- 1 Aufbaueinspeisung / Surface power feed
- 2 Magnetics Schiene / Magnetics track
- 3 L - Verbinder / L - connector
- 4 Lichteinsatz linear / Light insert linear
- 5 X - Verbinder / X - connector
- 6 Baldachin DALI / Ceiling base DALI
- 7 T - Verbinder / T - connector
- 8 Einbaueinspeisung / Recessed power feed
- 9 Sphere S SD Lichteinsatz / Sphere S SD light insert

- 10 Sphere M SD Lichteinsatz / Sphere M SD light insert
- 11 Sphere M PDI Lichteinsatz / Sphere M PDI light insert
- 12 Raster Lichteinsatz / Grid light insert
- 13 Raster Lichteinsatz asymm / Grid light insert asymm
- 14 Wand/- Deckenverbinder / Wall- ceiling connector
- 15 Strahlereinsatz S / Spot insert S
- 16 Strahlereinsatz M / Spot insert M
- 17 Strahlereinsatz L / Spot insert L
- 18 Strahlereinsatz XL / Spot insert XL
- 19 Endstück / End piece

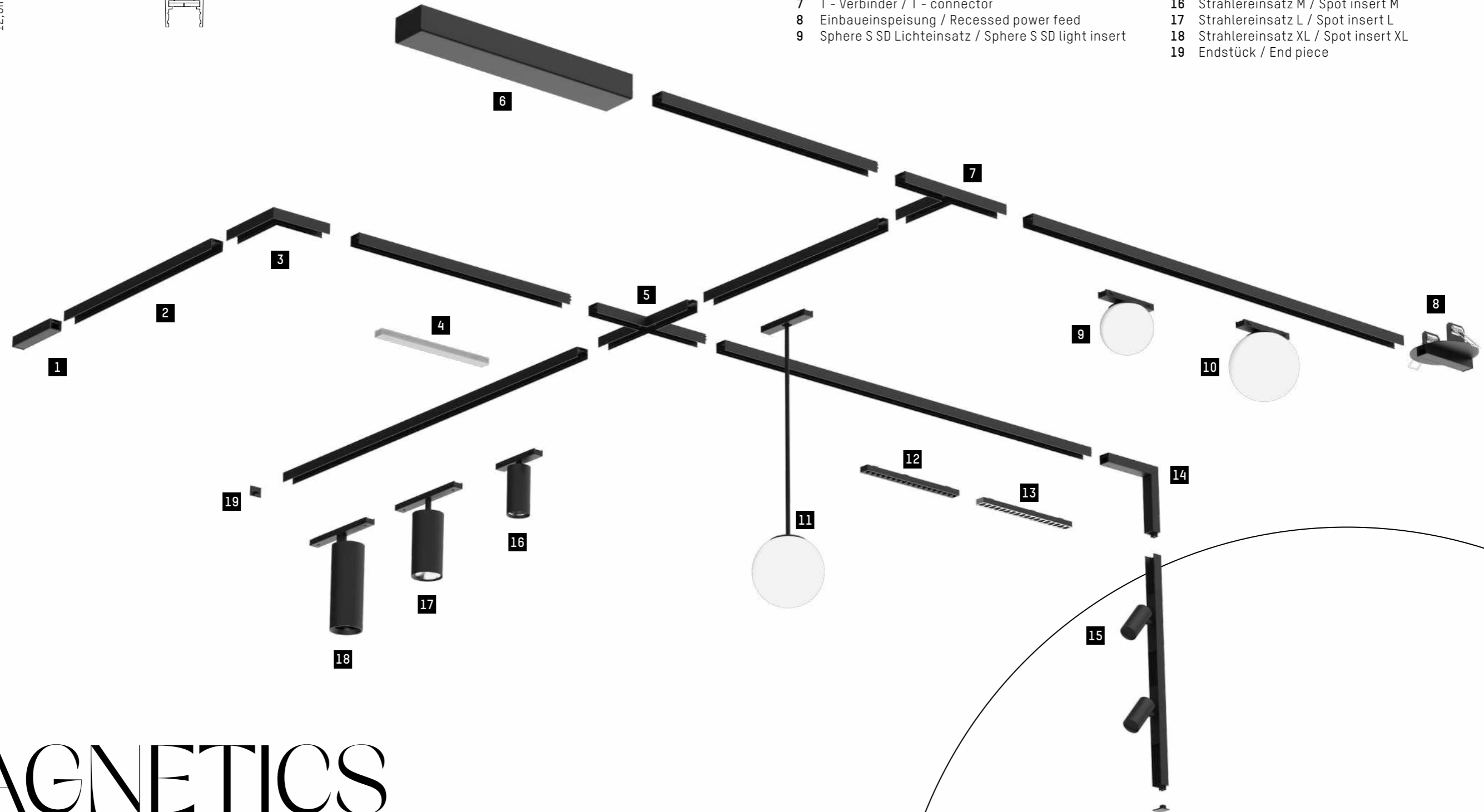

MAGNETICS SYSTEM

TRACK COMPONENTS

24V DC

Design: INHOUSE IP20 CE

24V Stromschiene aus Aluminiumprofil · 4-Polig · Oberfläche schwarz · Installation als Aufbau- und Einbaumontage · Systemzubehör separat ordern
 24V electrified track made of aluminium profile · 4-pole · black surface · installation as surface- and recessed · order system accessories separately
 Binario elettrificato 24V · 4 poli · in alluminio · finitura nera · montaggio a plafone o incasso · accessori da ordinare separatamente
 Rail électrifié en aluminium 24V · 4 pôles · finition noire · montage en surface ou encastré · accessoires à commander séparément

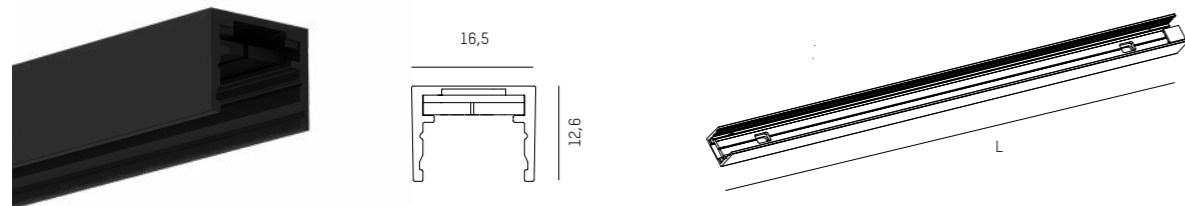

MAGNETICS PROFIL OHNE EINSPEISUNG MAGNETICS PROFILE WITHOUT POWER FEED	LÄNGE LENGHT	FARBE COLOUR
708-00101000006d	300mm	black
708-00102000006d	600mm	black
708-00103000006d	900mm	black
708-00104000006d	1200mm	black
708-00105000006d	1500mm	black
708-00106000006d	1800mm	black
708-00107000006d	2100mm	black
708-00108000006d	2400mm	black

MAGNETICS PROFIL MIT EINSPEISUNG MAGNETICS PROFILE WITH POWER FEED	LÄNGE LENGHT	FARBE COLOUR
708-00122000006d	379mm	black
708-00123000006d	679mm	black
708-00124000006d	979mm	black
708-00125000006d	1279mm	black
708-00126000006d	1579mm	black
708-00127000006d	1879mm	black
708-00128000006d	2179mm	black
708-00129000006d	2479mm	black

ENDSTÜCK END PIECE	FARBE COLOUR
708-006010000060	black

EINBAUMONTAGESET RECESSED MOUNTING SET	L: SCHUTZABDECKUNG L: PROTECTIVE COVER
708-0000200	900mm
708-0000600	1800mm
708-0000700	2700mm

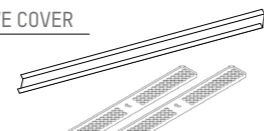

JUMPER - KONTAKTBRÜCKE JUMPER - CONTACT BRIDGE
708-00005000006d

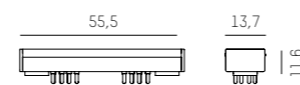

best. aus 2 Einbaubügel und 1 Stk. PMMA Schutzabdeckung
 Consisting of 2 installation brackets and 1 pc. PMMA protective cover

JUNCTION

90° VERBINDER 90° JUNCTION	FARBE COLOUR	ECKE CORNER
708-00511000006d	black	links/left
708-00501000006d	black	rechts/right

inkl. 1 Stk. Platinenverbinder
 incl. 1 pce. board junction

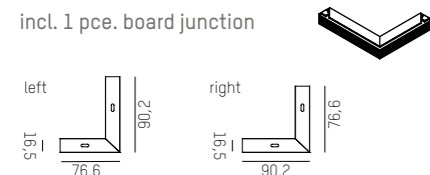

90° WAND / DECKENVERBINDER 90° WALL/CEILING JUNCTION	FARBE COLOUR
708-00502000006d	black

inkl. 1 Stk. Platinenverbinder
 incl. 1 pce. board junction

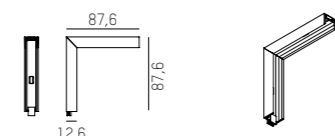

T VERBINDER T JUNCTION	FARBE COLOUR
708-00504000006d	black

inkl. 2 Stk. Platinenverbinder
 incl. 2 pce. board junction

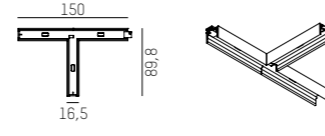

X VERBINDER X JUNCTION	FARBE COLOUR
708-00505000006d	black

inkl. 3 Stk. Platinenverbinder
 incl. 3 pce. board junction

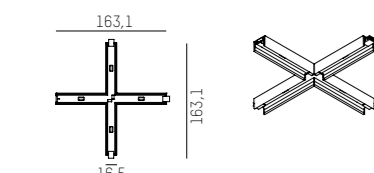

PLATINENVERBINDUNGSSET BOARD JUNCTION SET	FARBE COLOUR
708-00001000006d	black

5 Stk. (Ersatzteil)
 5 pcs. (spare part)



FLEXVERBINDER FLEXIBLE JUNCTION	FARBE COLOUR
708-00503000006d	black

inkl. 1 Stk. Platinenverbinder
 muss vor Ort geschnitten werden
 incl. 1 pce. board junction
 must be cut on site

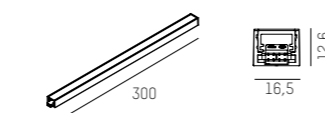

SYSTEM COMPONENTS

POWER FEED

Alle Einspeisungen für ON/Off und Dali nutzbar, je nach Modell inkl. oder exkl. DALI Repeater, Anschlussmöglichkeit für DALI ist bei allen Modellen möglich. ACHTUNG: Kein Push-Dimm-Betrieb möglich

All feeds for On/Off and Dali usable, depending on the model incl. or excl. DALI repeater, connection option for DALI is possible with all models. ATTENTION: No push dimming operation possible

DALI REPEATER FÜR GALVANISCHE TRENNUNG DALI REPEATER FOR GALVANIC SEPERATION	LEISTUNG POWER
---	-------------------

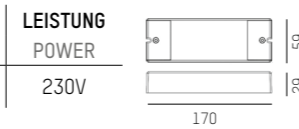

711-sr2400amp
 max. 64 DALI Adressen
 max. 64 DALI adresses

AUFBAUEINSPEISUNG MITTE / ENDE SURFACE CENTER / END POWER FEED	FARBE COLOUR
---	-----------------

708-00401000006d
 inkl. Endstück, exkl. LED Konverter
 incl. end piece, excl. LED driver

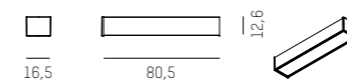

EINBAUEINSPEISUNG MITTE / ENDE RECESSED CENTER / END POWER FEED	FARBE COLOUR
--	-----------------

708-00405000006d
 inkl. Endstück, exkl. LED Konverter
 incl. end piece, excl. LED driver

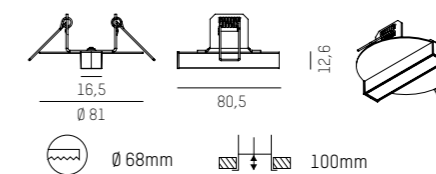

LED KONVERTER MAGNETICS LED DRIVER MAGNETICS	LEISTUNG COLOUR
---	--------------------

24-127824
 schaltbar
 switchable

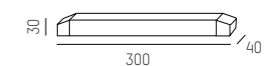

BALDACHIN DALI CEILING BASE DALI	LEISTUNG POWER	FARBE COLOUR
-------------------------------------	-------------------	-----------------

708-00403000006d
 Inkl. LED Konverter / incl. LED driver



Anschluss einseitig
 Feed in one-sided

BALDACHIN DALI CEILING BASE DALI	LEISTUNG POWER	FARBE COLOUR
-------------------------------------	-------------------	-----------------

708-00404000006d
 Inkl. LED Konverter / incl. LED driver

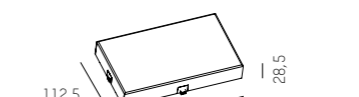

Anschluss vierseitig
 Feed in four-sided

BALDACHIN DALI CEILING BASE DALI	LEISTUNG POWER	FARBE COLOUR
-------------------------------------	-------------------	-----------------

708-00406000006d
 inkl. LED Konverter
 inkl. DALI Repeater für galvanische Trennung
 incl. LED driver
 incl. DALI repeater for galvanic separation

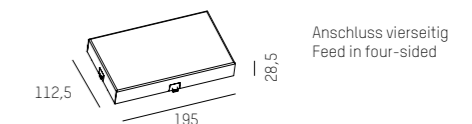

Anschluss vierseitig
 Feed in four-sided

ANSCHLUSSSCHEMA / EXAMPLE OF CONNECTION

schaltbar
 switchable

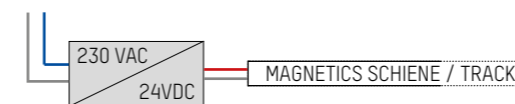

DALI dimmbar
 DALI dimmable

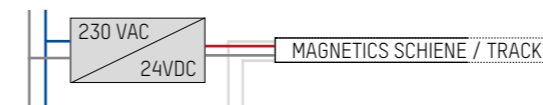

DALI Repeater für galvanische separation
 DALI repeater for galvanic separation

DALI Eingang
 DALI input



MAGNETICS SYSTEM

FOR SURFACE & RECESSED MOUNTING

SYSTEM COMPONENTS

MAGNETICS H PROFIL
MAGNETICS H PROFILE
L: 300 - 2400mm

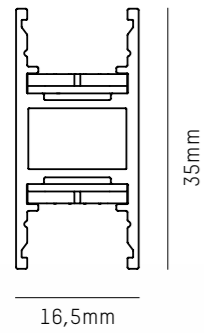

SYSTEM WAND ODER PENDELMONTAGE
SYSTEM WALL OR PENDANT MOUNTING
DIREKT / INDIREKT STRAHLEND
DIRECT / INDIRECT LIGHT BEAM

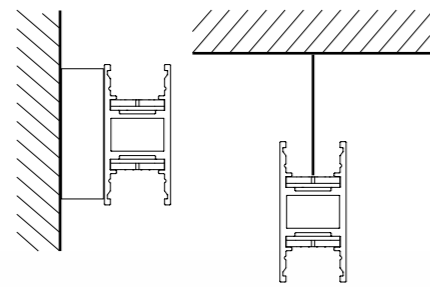

EINZEL WAND, PENDEL ODER STEHLEUCHTEN
SINGLE WALL, PENDANT OR STAND LUMINAIRE

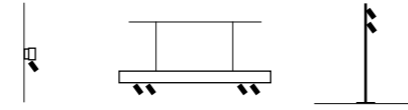

PENDANT VERSION

- 1 Endstück / End piece
- 2 Sphere M PDI Lichteinsatz / Sphere M PDI light insert
- 3 T - Verbinder / T - connector
- 4 Magnetics H Schiene / Magnetics H track
- 5 Abhängung / Suspension
- 6 Sphere S SD Lichteinsatz / Sphere S SD light insert
- 7 Sphere M SD Lichteinsatz / Sphere M SD light insert
- 8 Pendeleinspeisung / Pendant power feed
- 9 Raster Lichteinsatz / Grid light insert
- 10 Raster Lichteinsatz asymm / Grid light insert asymm
- 11 Lichteinsatz linear / Light insert linear
- 12 X - Verbinder / X - connector
- 13 Strahlereinsatz S / Spot insert S
- 14 Strahlereinsatz M / Spot insert M
- 15 Strahlereinsatz L / Spot insert L
- 16 Strahlereinsatz XL / Spot insert XL
- 17 L - Verbinder / L - connector

WALL VERSION

- 18 Endstück / End piece
- 19 Magnetics H Schiene / Magnetics H track
- 20 Wandeinspeisung / Wall power feed
- 21 Lichteinsatz linear / Light insert linear
- 22 Strahlereinsatz S / Spot insert S
- 23 L - Verbinder / L - connector
- 24 Wandhalterung / Wall bracket

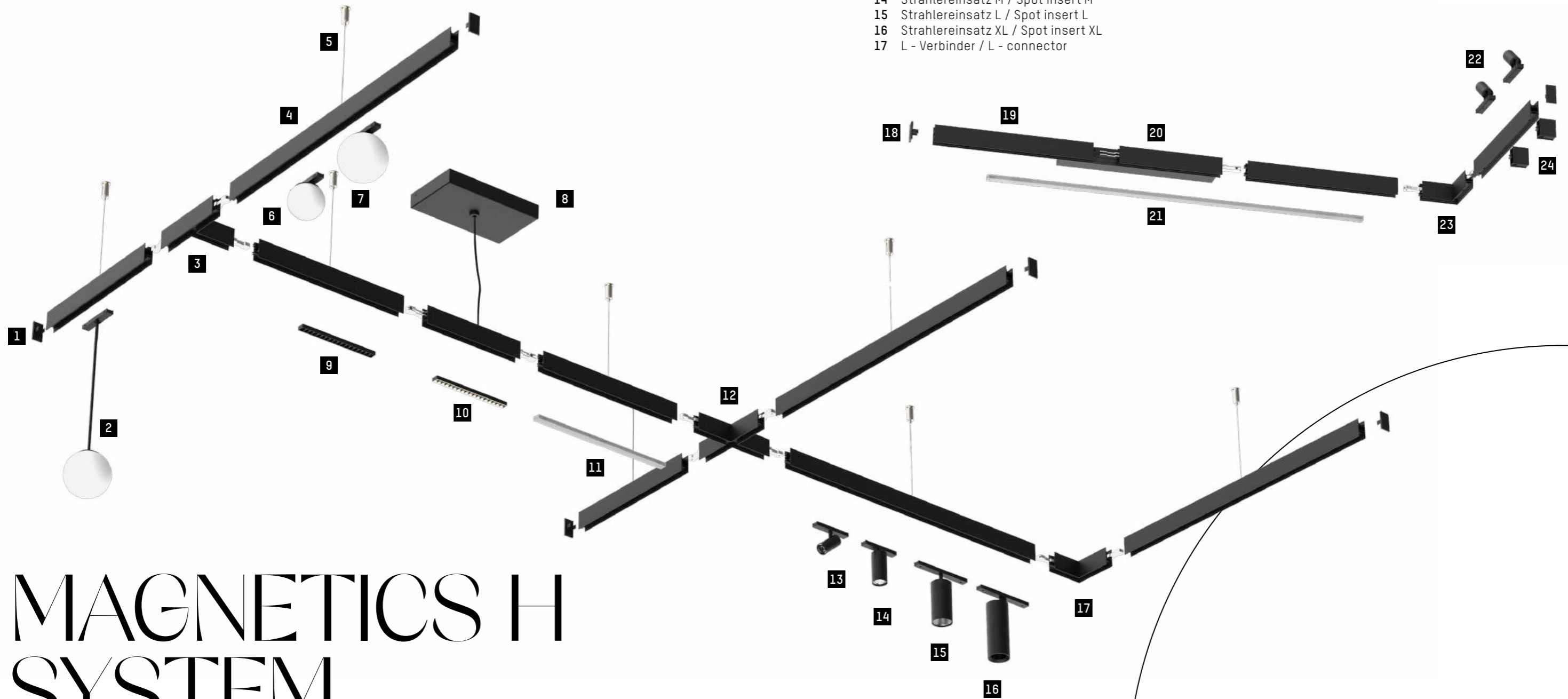

MAGNETICS H SYSTEM

TRACK COMPONENTS PENDANT

24V DC

Design: INHOUSE IP20 CE

24V Stromschiene aus Aluminiumprofil · 4-polig · Oberfläche schwarz · Installation als Pendelmontage · Systemzubehör & Lichteinsätze separat ordern
 24V electrified track made of aluminium profile · 4-pole · black surface · suspension mounting · order system accessories separately
 Binario elettrificato 24V · 4 poli · in alluminio · finitura nera · montaggio a sospensione · accessori ed inserti luminosi da ordinare separatamente
 Rail électrifié en aluminium 24V · 4 pôles · finition noire · montage en suspension · accessoires et inserts lumineux à commander séparément



MAGNETICS H PROFIL MAGNETICS H PROFILE	LÄNGE LENGHT	FARBE COLOUR
708-00701000006d	300mm	black
708-00702000006d	600mm	black
708-00703000006d	900mm	black
708-00704000006d	1200mm	black
708-00705000006d	1500mm	black
708-00706000006d	1800mm	black
708-00707000006d	2100mm	black
708-00708000006d	2400mm	black

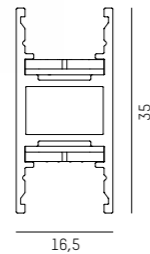

ENDSTÜCK END PIECE	FARBE COLOUR
708-006020000060	black

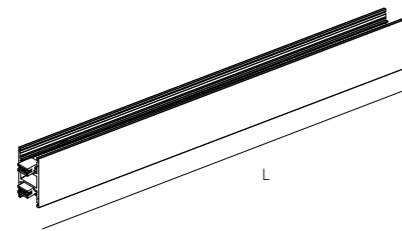
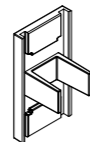

JUNCTION

LINEARVERBINDER LINEAR JUNCTION	FARBE COLOUR
708-005060000060	aluminium

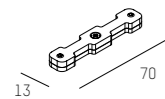

90° VERBINDER 90° JUNCTION	FARBE COLOUR
708-00507000006d	black

inkl. 2 Stk. Platinenverbinder
incl. 2 pce. board junction

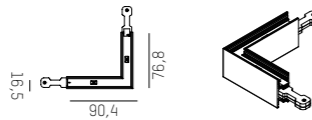

T VERBINDER T JUNCTION	FARBE COLOUR
708-00508000006d	black

inkl. 4 Stk. Platinenverbinder
incl. 4 pce. board junction

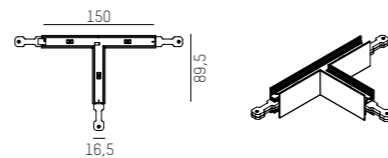

X VERBINDER X JUNCTION	FARBE COLOUR
708-00509000006d	black

inkl. 6 Stk. Platinenverbinder
incl. 6 pce. board junction

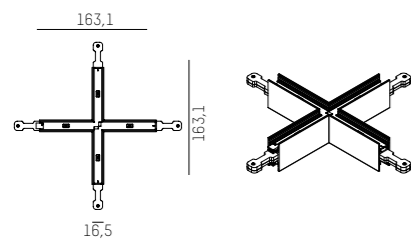

KABELABHÄNGUNG CABLE SUSPENSION	FARBE COLOUR
708-008010000060	nichel

L: max. 1500mm

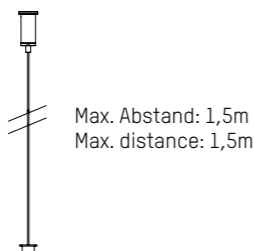

PLATINENVERBINDUNGSSET BOARD JUNCTION SET	FARBE COLOUR
708-00001000006d	black

5 Stk. (Ersatzteil)
5 pcs. (spare part)



SYSTEM COMPONENTS

POWER FEED

Alle Einspeisungen für ON/Off und Dali nutzbar, je nach Modell inkl. oder exkl. DALI Repeater, Anschlussmöglichkeit für DALI ist bei allen Modellen möglich.
 ACHTUNG: Kein Push-Dimm-Betrieb möglich

All feeds for ON/Off and Dali Usable, depending on the model incl. or excl. DALI repeater, connection option for DALI is possible with all models.
 ATTENTION: No push dimming operation possible

DALI REPEATER FÜR GALVANISCHE TRENNUNG DALI REPEATER FOR GALVANIC SEPERATION	LEISTUNG POWER
711-sr2400amp	230V

max. 64 DALI Adressen
max. 64 DALI adresses

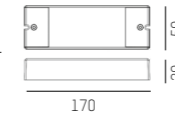

PENDELEINSPEISUNG MITTE / ENDE PENDANT CENTER / END POWER FEED	LEISTUNG POWER	FARBE COLOUR
708-00408000006d	2 x max. 100W	black

Baldachin inkl. LED Konverter, inkl. Verbinder und Enddeckel
Ceiling base incl. LED driver, incl. connector and end piece

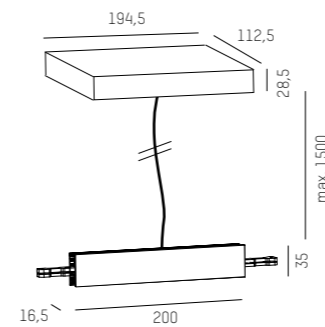

PENDELEINSPEISUNG MITTE / ENDE PENDANT CENTER / END POWER FEED	LEISTUNG POWER	FARBE COLOUR
708-00409000006d	max. 100W	black

Baldachin inkl. LED Konverter, inkl. Verbinder und Enddeckel
Inkl. DALI Repeater für galvanische Trennung
Ceiling base incl. LED driver, incl. connector and end piece
incl. DALI repeater for galvanic separation

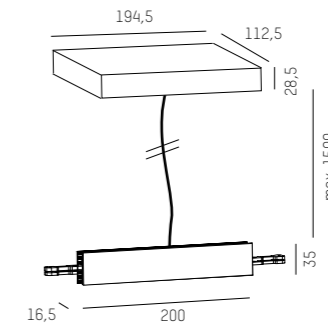

ANSCHLUSSSCHEMA / EXAMPLE OF CONNECTION

schaltbar
switchable

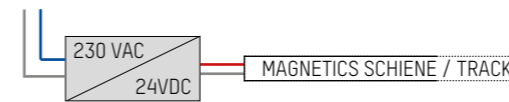

DALI dimmbar
DALI dimmable



DALI Repeater für galvanische separation
DALI repeater for galvanic separation

DALI Eingang
DALI input

**MAGNETICS H
PDI SYSTEM**

FOR PENDANT MOUNTING



SYSTEM COMPONENTS

TRACK COMPONENTS WALL

24V DC

Design: INHOUSE IP20 CE

24V Stromschiene aus Aluminiumprofil · 4-polig · Oberfläche schwarz · Installation als Pendelmontage · Systemzubehör & Lichteinsätze separat ordern
 24V electrified track made of aluminium profile · 4-pole · black surface · suspension mounting · order system accessories separately
 Binario elettrificato 24V · 4 poli · in alluminio · finitura nera · montaggio a sospensione · accessori ed inserti luminosi da ordinare separatamente
 Rail électrifié en aluminium 24V · 4 pôles · finition noire · montage en suspension · accessoires et inserts lumineux à commander séparément



MAGNETICS H PROFIL MAGNETICS H PROFILE	LÄNGE LENGHT	FARBE COLOUR
708-00701000006d	300mm	black
708-00702000006d	600mm	black
708-00703000006d	900mm	black
708-00704000006d	1200mm	black
708-00705000006d	1500mm	black
708-00706000006d	1800mm	black
708-00707000006d	2100mm	black
708-00708000006d	2400mm	black

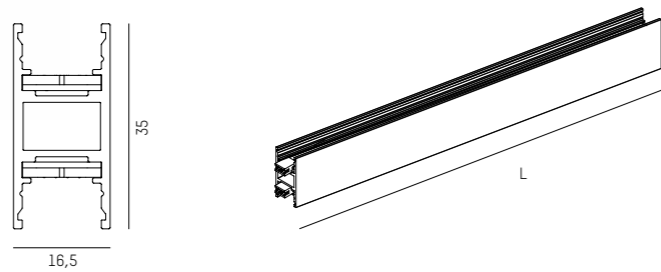

ENDSTÜCK END PIECE	FARBE COLOUR
708-006020000060	black

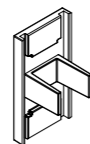

JUNCTION

LINEARVERBINDER LINEAR JUNCTION	FARBE COLOUR
708-005060000060	aluminium

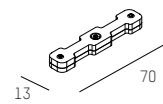

90° VERBINDER 90° JUNCTION	FARBE COLOUR
708-00507000006d	black

inkl. 2 Stk. Platinenverbinder
incl. 2 pce. board junction

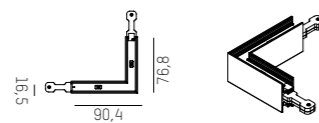

WANDHALTERUNG WALL BRACKET	FARBE COLOUR
708-008020000060	black

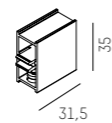

JE PROFILLÄNGE ORDERN ORDER PER PROFILE LENGTH	STÜCK COLOUR
300mm	2
600mm	2
900mm	2
1200mm	2
1500mm	2
1800mm	3
2100mm	3
2400mm	3

POWER FEED

Alle Einspeisungen für ON/Off und Dali Nutzbar, je nach Modell inkl. oder exkl. DALI Repeater, Anschlussmöglichkeit für DALI ist bei allen Modellen möglich.
 ACHTUNG: Kein Push-Dimm-Betrieb möglich

All feeds for ON/Off and Dali Usable, depending on the model incl. or excl. 24V DALI repeater, connection option for DALI is possible with all models.
 ATTENTION: No push dimming operation possible

DALI REPEATER FÜR GALVANISCHE TRENNUNG DALI REPEATER FOR GALVANIC SEPERATION	LEISTUNG POWER
711-sr2400amp	230V

max. 64 DALI Adressen
max. 64 DALI adresses

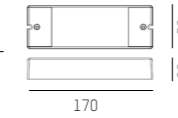

WANDEINSPEISUNG MITTE / ENDE WALL CENTER / END POWER FEED	LEISTUNG POWER	FARBE COLOUR
708-00407000006d	max. 100W	black

Wandhalterung inkl. LED Konverter, inkl. Verbinder und Enddeckel
 Wall base incl. LED driver, incl. connector and end piece

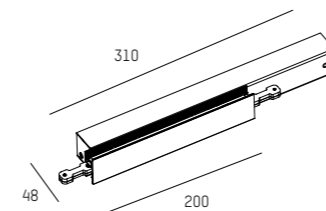

ANSCHLUSSSCHEMA / EXAMPLE OF CONNECTION

schaltbar
switchable

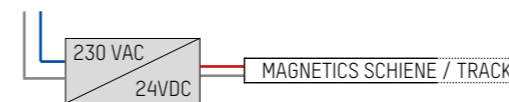

DALI dimmbar
DALI dimmable

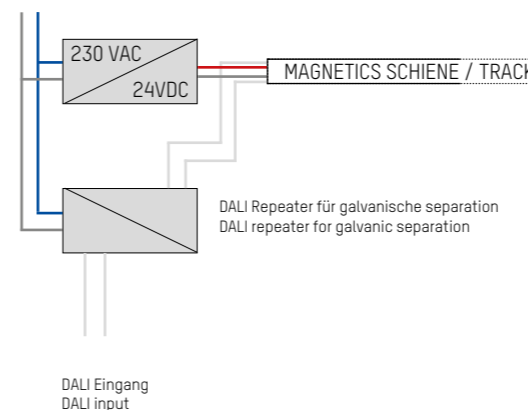

**MAGNETICS H
WALL SYSTEM**
FOR WALL MOUNTING



LIGHT INSERTS

LICHTEINSATZ GERADE / opal weiÙe oder opal schwarze Abdeckung
 LIGHT INSERT STRAIGHT / opal white or black cover

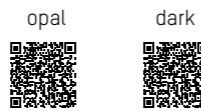

CODE	SYS W	L mm	LUMEN
708-00301COWW06Y	2	150	50 - 135
708-00303COWW06Y	4	300	100 - 270
708-00306COWW06Y	6	450	150 - 405
708-00304COWW06Y	8	600	200 - 540
708-00305COWW06Y	12	900	300 - 810

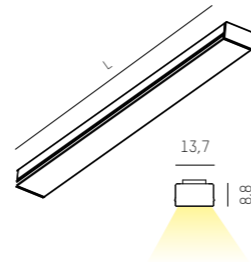

Opal Lichteinsatz
Opal light insert



Opal schwarze Abdeckung - Licht aus
Opal black cover - light off



Opal schwarze Abdeckung - Licht an
Opal black cover - light on

COMPLETE CODE

C = COVER	WW = LIGHT COLOUR	Y = DIMMABLE
☐ opal white = 1	W2 LED 2700K = 23 CRI>90	Ⓢ switchable = 0
☐ opal black = 4	W3 LED 3000K = 29 CRI>90	Ⓣ DALI dim = d
	W35 LED 3500K = 27 CRI>90	
	W4 LED 4000K = 24 CRI>90	

LICHTEINSATZ GRID / chrom oder dark chrom Reflektor
 LIGHT INSERT GRID / chrome or dark chrome reflector



CODE	SYS W	L mm	LUMEN
708-00301ROWW06Y	4	150	110 - 310



Dark Chrom 60° Lichtaustritt
Darkchrome 60° light beam



Chrom asymmetrischer Lichtaustritt
Chrome asymmetric light beam

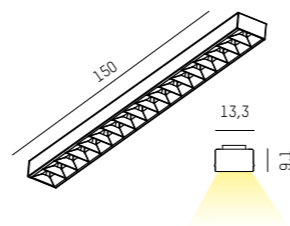

COMPLETE CODE

R = REFLECTOR	WW = LIGHT COLOUR	Y = DIMMABLE
☐ dark chrome - 60° beam = 2 (UGR<16)	W2 LED 2700K = 23 CRI>90	Ⓢ switchable = 0
☐ chrome - asymmetric beam = 3	W3 LED 3000K = 29 CRI>90	Ⓣ DALI dim = d
	W35 LED 3500K = 27 CRI>90	
	W4 LED 4000K = 24 CRI>90	



Intersport Tscherne, Salzburg, Austria
Photo: Joachim Rauch

MAGNETICS LINEAR LIGHT INSERTS

SPOT S EINSATZ / INSERT

mit Linse
with lens

CODE	SYS W	LUMEN
708-00201RRWW06Y	4	290 - 360

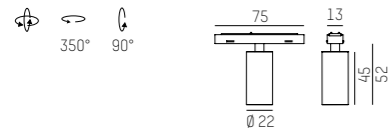
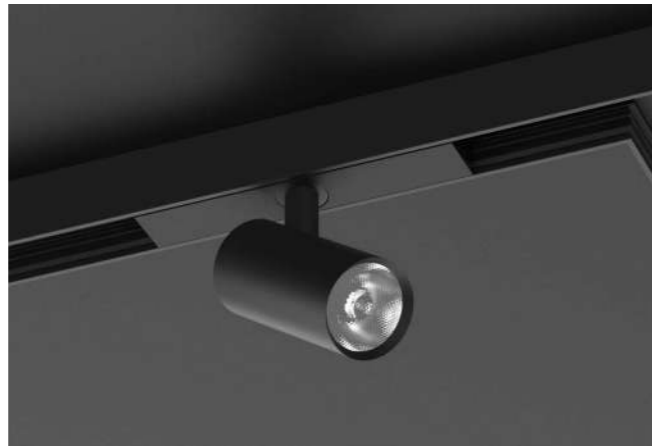
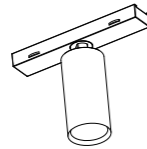

COMPLETE CODE		
RR = LENS	WW = LIGHT COLOUR	Y = DIMMABLE
<ul style="list-style-type: none"> 20° lens = 04 30° lens = 06 	<ul style="list-style-type: none"> W2 LED 2700K = 43 PREMIUM CRI>90 W3 LED 3000K = 49 PREMIUM CRI>90 W3S LED 3500K = 47 PREMIUM CRI>90 W4 LED 4000K = 24 CRI>90 	<ul style="list-style-type: none"> Ⓢ switchable = 0 Ⓣ DALI dim = d

SPOT L EINSATZ / INSERT

mit Linse oder Reflektor
with lens or reflector

CODE	SYS W	LUMEN
708-10203RRWW06Y	11 - 15	640 - 1130

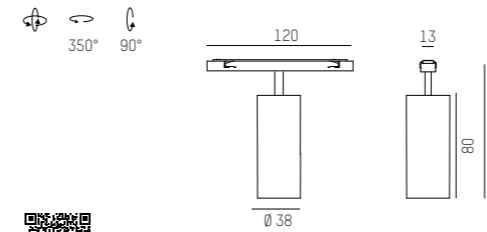
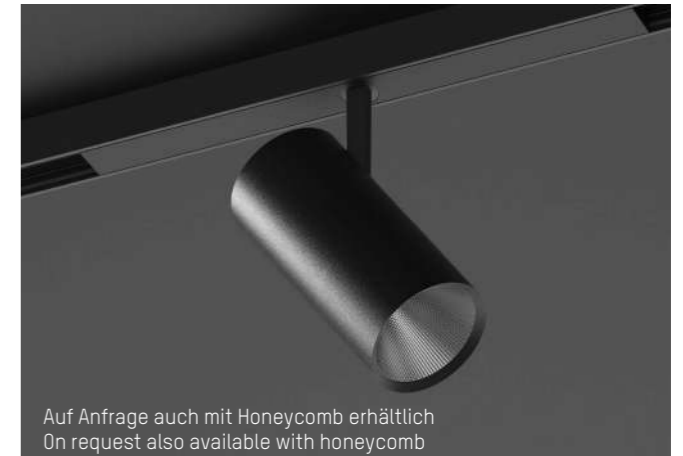
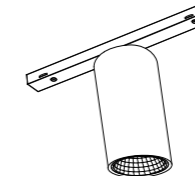

Auf Anfrage auch mit Honeycomb erhältlich
On request also available with honeycomb

COMPLETE CODE			
RR = REFLECTOR OR GLASS LENS	WW = LIGHT COLOUR	Y = DIMMABLE	
<ul style="list-style-type: none"> 14° lens = 04 24° lens = 05 45° lens = 06 	<ul style="list-style-type: none"> 24° chrome = 02 45° chrome = 03 	<ul style="list-style-type: none"> 24° dark chrome = 08 45° dark chrome = 09 	<ul style="list-style-type: none"> W2 LED 2700K = 43 PREMIUM CRI>90 W3 LED 3000K = 49 PREMIUM CRI>90 W3S LED 3500K = 47 PREMIUM CRI>90 W4 LED 4000K = 24 CRI>90
			<ul style="list-style-type: none"> Ⓢ switchable = 0 Ⓣ DALI dim = d

SPOT M EINSATZ / INSERT

mit Reflektor
with reflector

CODE	SYS W	LUMEN
708-00202RRWW06Y	7	210 - 480

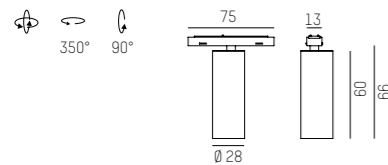
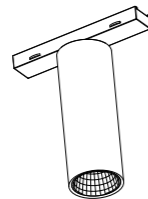

COMPLETE CODE		
RR = REFLECTOR	WW = LIGHT COLOUR	Y = DIMMABLE
<ul style="list-style-type: none"> 24° chrome = 02 38° chrome = 03 24° dark chrome = 08 38° dark chrome = 09 	<ul style="list-style-type: none"> W2 LED 2700K = 43 PREMIUM CRI>90 W3 LED 3000K = 49 PREMIUM CRI>90 W3S LED 3500K = 47 PREMIUM CRI>90 W4 LED 4000K = 24 CRI>90 	<ul style="list-style-type: none"> Ⓢ switchable = 0 Ⓣ DALI dim = d

MAGNETICS SPOT LIGHT INSERTS

SPOT XL EINSATZ / INSERT

X-CHANGE TECHNOLOGY

mit Linse oder Reflektor
with lens or reflector

CODE	SYS W	LUMEN
708-017RRRXX06Y	6	300 - 671

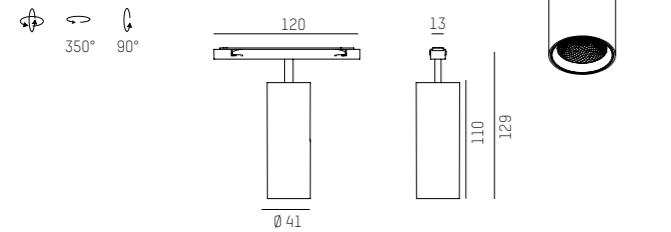

COMPLETE CODE

RRRR = REFLECTOR OR GLASS LENS		WW = LIGHT COLOUR	Y = DIMMABLE
17° lens = 0102	12° chrome = 0101	W24 LED 2400K = 22 CRI>90	Ⓢ switchable = 0
24° lens = 0209	17° chrome = 0202	W2 LED 2700K = 43 PREMIUM CRI>90	Ⓣ DALI dim = d
50° lens = 0307	30° chrome = 0303	W3 LED 3000K = 49 PREMIUM CRI>90	
	50° chrome = 0305	W35 LED 3500K = 47 PREMIUM CRI>90	
		W4 LED 4000K = 24 CRI>90	

SPOT XL EINSATZ / INSERT

X-CHANGE TECHNOLOGY

mit Linse oder Reflektor
with lens or reflector

CODE	SYS W	LUMEN
708-017RRRXX06Y	12	535 - 1198

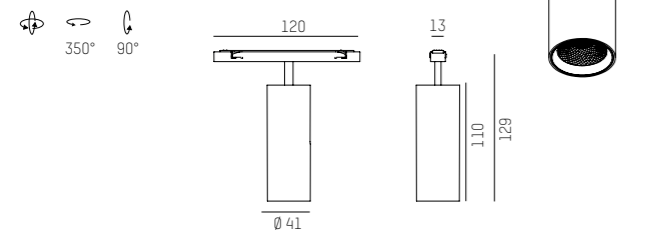

COMPLETE CODE

RRRR = REFLECTOR OR GLASS LENS		WW = LIGHT COLOUR	Y = DIMMABLE
30° lens = 0404	30° chrome = 0403	W24 LED 2400K = 22 CRI>90	Ⓢ switchable = 0
50° lens = 0407	50° chrome = 0405	W2 LED 2700K = 43 PREMIUM CRI>90	Ⓣ DALI dim = d
		W3 LED 3000K = 49 PREMIUM CRI>90	
		W35 LED 3500K = 47 PREMIUM CRI>90	
		W4 LED 4000K = 24 CRI>90	



MAGNETICS SPOT LIGHT INSERTS



Light & Building 2024, Frankfurt, Germany, Photo: Joachim Rauch

SPHERE SD EINSATZ / INSERT

mit satiniertes Glaskugel
with satined glass ball

CODE	SYS W	Ø mm	LUMEN
708-0160100WW06Y	5	60	250 - 260
708-0160200WW06Y	5	80	280 - 290

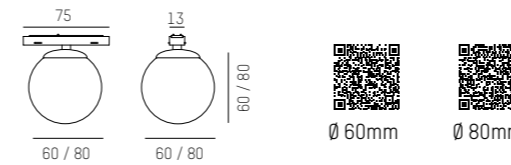
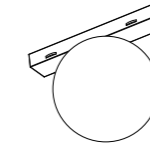

SPHERE PDI EINSATZ / INSERT

mit satiniertes Glaskugel
with satined glass ball

CODE	SYS W	Ø mm	LUMEN
708-0150200WW06Y	5	80	280 - 290

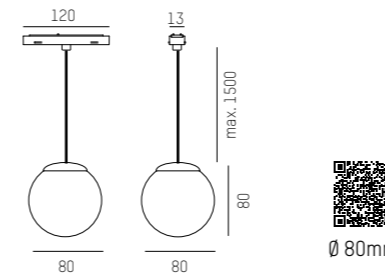
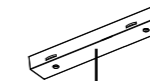

COMPLETE CODE

WW = LIGHT COLOUR		Y = DIMMABLE	
W24	LED 2400K = 22 CRI>90	Ⓢ	switchable = 0
W2	LED 2700K = 23 CRI>90	Ⓣ	DALI dim = d
W3	LED 3000K = 29 CRI>90		

MAGNETICS SPHERE LIGHT INSERTS

VOLARE

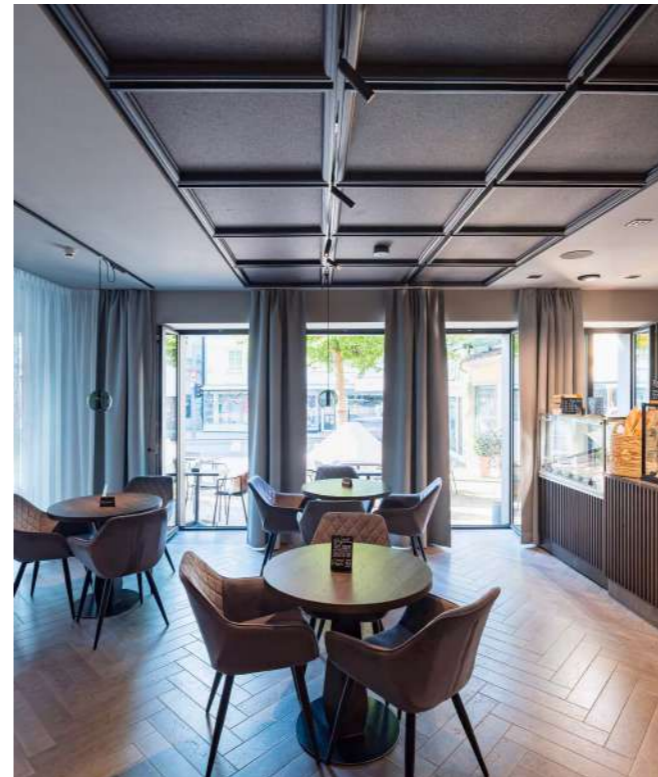

La Sonett, Gmunden, Austria, Photo: Joachim Rauch



Honkey Distillery, Rohrbach, Austria, Photo: Joachim Rauch



Private residence, Austria, Photo: Joachim Rauch

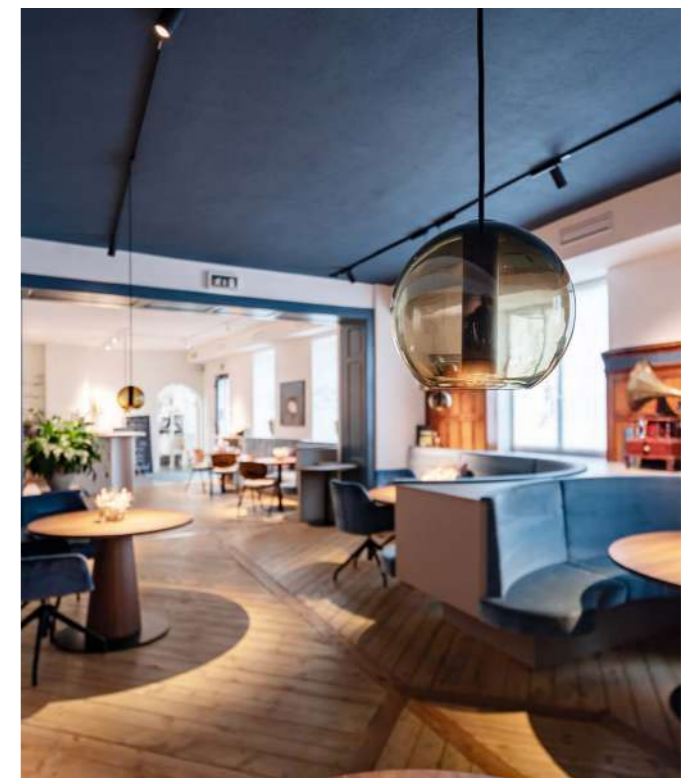

Liepert's Kulinarium, Leutschach, Austria, Photo: Joachim Rauch



Private residence, Austria
 Planing: Ben Elmecker
 Photo: Martin Pröll

VOLARE

THE SMALLEST 2-PHASE TRACK SYSTEM IN THE WORLD

Die Alternative für Menschen, die das Zarte und das Besondere suchen. Minimalismus und Purismus werden in einer 230V 2-Phasen Schiene mit 18x18mm vereint. Volare ist weltweit das kleinste 2-Phasen-Stromschienensystem. Einfachste Montage der Schienen direkt an Wand oder Decke durch vorgebohrte Löcher oder als abgehängte Versionen mittels Seil oder Stangen. Der neue Adapter besticht nicht nur durch seine kompakte Bauform, sondern ist auch völlig unkompliziert in der Schiene zu fixieren.

The alternative for those who are looking for something delicate and special. Minimalism and purism are united in a 230V two-phase 18x18mm rail. Volare is currently the smallest two-phase power rail system worldwide. Pre-drilled holes make rails extremely simple to fit to walls and ceilings or as pendant versions with cables and rods. The new adaptor is not only impressively small but is also extremely simple to fit into the rail.

Design: INHOUSE

VARIATIONS

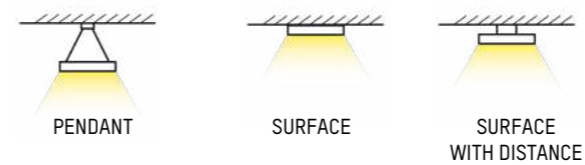

TRACK 18x18mm



COLOURS TRACK



PENDANTS

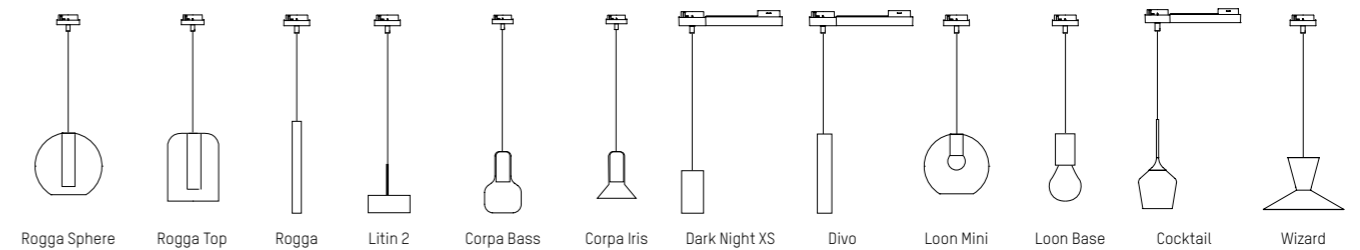

SPOTS

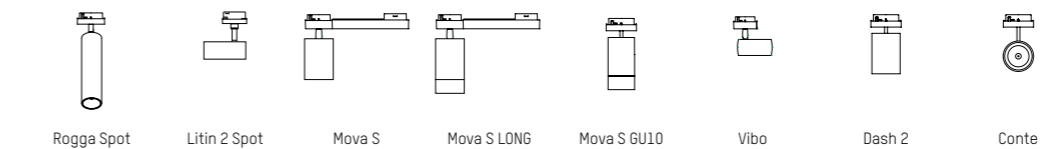

LUMINAIRES

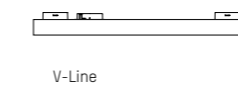

2-PHASE TRACK

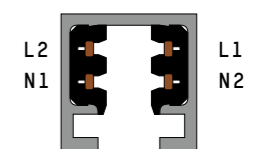

MASSTAB 1:1 / SCALE 1:1

OPTIONS

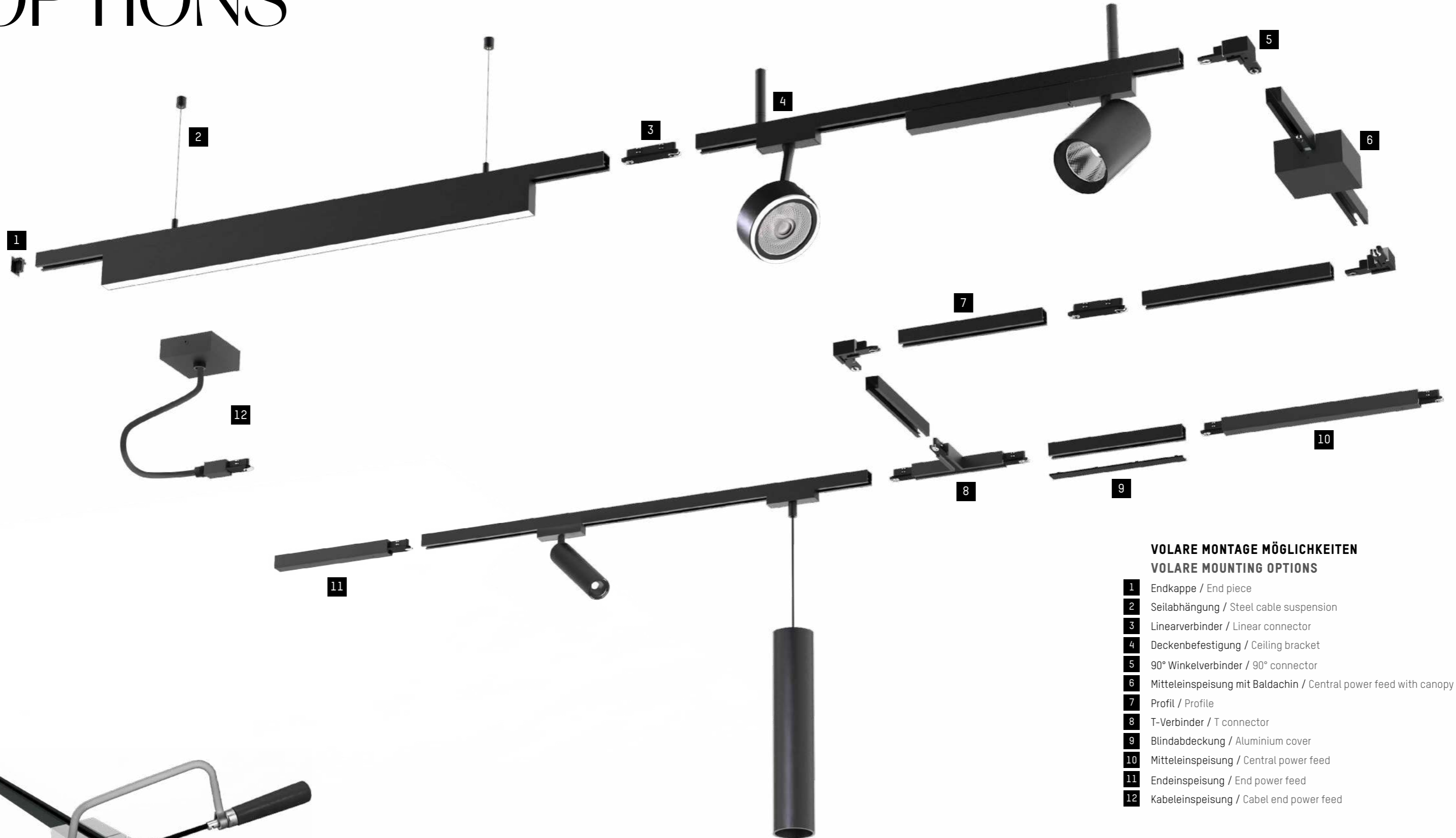

VOLARE MONTAGE MÖGLICHKEITEN VOLARE MOUNTING OPTIONS

- 1 Endkappe / End piece
- 2 Seilabhängung / Steel cable suspension
- 3 Linearverbinder / Linear connector
- 4 Deckenbefestigung / Ceiling bracket
- 5 90° Winkelverbinder / 90° connector
- 6 Mitteleinspeisung mit Baldachin / Central power feed with canopy
- 7 Profil / Profile
- 8 T-Verbinder / T connector
- 9 Blindabdeckung / Aluminium cover
- 10 Mitteleinspeisung / Central power feed
- 11 Endeinspeisung / End power feed
- 12 Kabeleinspeisung / Cabel end power feed

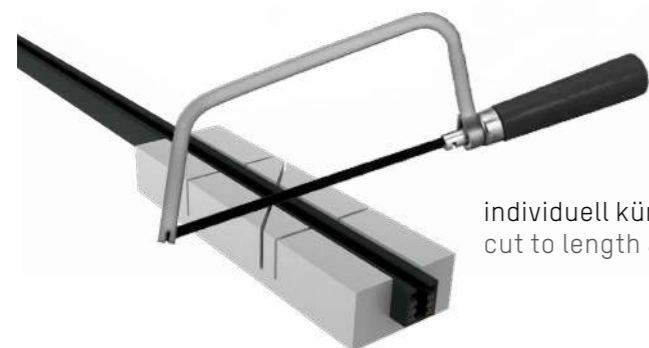

individuell kürzbar
cut to length as required

VOLARE

Einbau | Installation



Ausbau | Removal

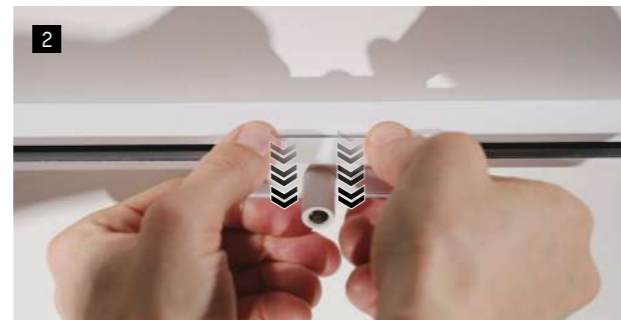

VOLARE DIM

Einbau | Installation



Ausbau | Removal



MONTAGEVIDEO
MOUNTING VIDEO



Private residence, Austria, Photo: Joachim Rauch

ROGGA SPOT

ROGGA SPOT VOLARE

IP20

220-240V AC 50/60Hz Design: INHOUSE

LED Schienenstrahler aus Aluminium · Oberfläche pulverbeschichtet · LED Konverter im Rohr integriert (AC Version) · Online konfigurierbar
 LED track spotlight in aluminium · surface powder-coated · LED converter integrated in the tube (AC version) · can be configured online
 Proiettore LED in alluminio · verniciatura a polveri · alimentatore LED integrato nell' tubo (AC versione) · configurabile online
 Projecteur LED en aluminium · vernissage à poudres · alimentation LED intégrée dans l'tube (AC version) · configurable en ligne

↔
350° 110°

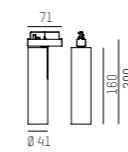

ROGGA AC Volare
6,5 - 12W
300-1220lm

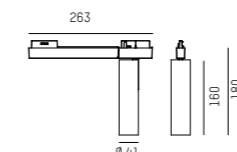

ROGGA LONG DC Volare
6,5 - 12W
300-1220lm

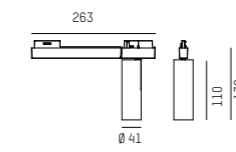

ROGGA SHORT DC Volare
6,5 - 12W
300-1220lm

PHASENSCHNITT DIM
PHASECUT DIM



PHASE-CUT

Optik / optics



Reflektor/
reflector

Dark Reflektor/
dark reflector

Linse/
lens

LFO
lens

Zubehör / accessories



Schutzglas/
safety glass

Wabenraster/
honeycomb

Streulinse/
spread lens



configurable





Galerie am See, Velden, Austria, Photo: Joachim Rauch

MOVA S

MOVA S SPOT VOLARE

220-240V AC 50/60Hz Design: INHOUSE

IP20

LED Schienenstrahler aus Aluminium · Oberfläche pulverbeschichtet · LED Konverter im Adapter integriert · Online konfigurierbar
 LED track spotlight in aluminium · surface powder-coated · LED converter integrated in the adapter · can be configured online
 Proiettore LED in alluminio · verniciatura a polveri · alimentatore LED integrato nell'adattatore · configurabile online
 Projecteur LED en aluminium · vernissage à poudres · alimentation LED intégrée dans l'adaptateur · configurable en ligne

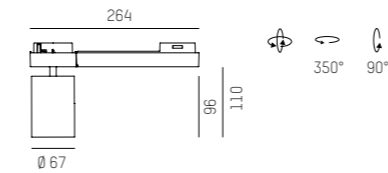

MOVA S Volare
 8 - 20W
 380 - 2240lm

Optik / optics

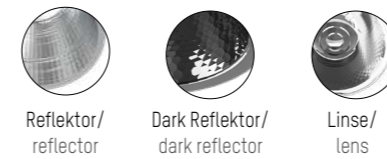

Reflektor/
reflector

Dark Reflektor/
dark reflector

Linse/
lens

Zubehör / accessories



Schutzglas/
safety glass

Wabenraster/
honeycomb

Streulinse/
spread lens

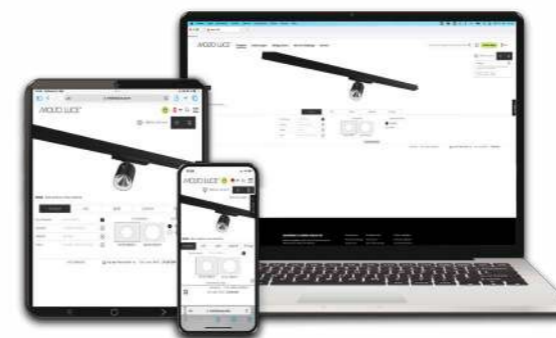

configurable





Private residence, Austria, Photo: F1 Fotodesign, Oliver Mitterhumer

MOVA S LONG

MOVA S L SPOT VOLARE

220-240V AC

50/60Hz

Design: INHOUSE

IP20

LED Schienenstrahler aus Aluminium · Oberfläche pulverbeschichtet · LED Konverter im Adapter integriert · Online konfigurierbar
 LED track spotlight in aluminium · surface powder-coated · LED converter integrated in the adapter · can be configured online
 Proiettore LED in alluminio · verniciatura a polveri · alimentatore LED integrato nell'adattatore · configurabile online
 Projecteur LED en aluminium · vernissage à poudres · alimentation LED intégrée dans l'adaptateur · configurable en ligne

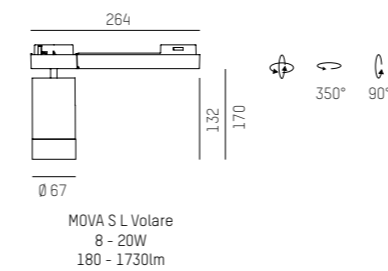

Optik / optics

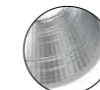
Reflektor/
reflectorDark Reflektor/
dark reflectorLinse/
lens

Zubehör / accessories

Schutzglas/
safety glassWabenraster/
honeycombStreulinse/
spread lens



MOVA S GU10

MOVA S GU10 VOLARE

220-240V AC

50/60Hz

QPAR 16 / GU10 / Retrofit max. 9W

Design: INHOUSE

IP20

LED Schienenstrahler aus Aluminium · Oberfläche pulverbeschichtet · Passend für LED Retrofit QPAR 16 · exkl. Leuchtmittel

LED track spotlight made of aluminium · surface powder-coated · suitable for LED Retrofit QPAR 16 · Without lamps

Proiettore LED in alluminio · verniciatura a polveri · compatibile con lampadine LED Retrofit QPAR16 · Lampadine escluse

Projecteur LED en aluminium moulé sous pression · vernissage à poudres · compatible avec les ampoules LED QPAR16 Retrofit · sans ampoules

CODE

495-42000000XX0

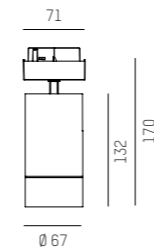

LEUCHTMITTEL 6W CRI>90

BULB 6W CRI>90

30-752517

30-707692

LICHTFARBE

COLOUR

2700K / 355lm

3000K / 375lm



COMPLETE CODE

XX = COLOUR

grey = 44

white = 55

black = 66



DASH 2

DASH 2 VOLARE

220-240V AC 50/60Hz Design: INHOUSE UGR<19

IP20

Schienenstrahler aus Aluminium · Oberfläche pulverbeschichtet · Strahler 350° dreh-, 90° schwenkbar
Track spotlight made of aluminium - powder-coated surface - Spotlight 350° rotatable, 90° swivelling
Proiettore da binario in alluminio · Superficie verniciata a polveri · Testa girevole 350°, orientabile 90°
Projecteur sur rail en aluminium - Surface revêtue de poudre - Tête orientable à 350°, pivotante à 90°

CODE	SYS W	LUMEN
599-103010RWWXX0	10	510 - 580

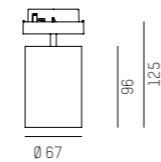

COMPLRTE CODE

R = BEAM ANGLE

- spot 17° = 2
- medium 24° = 3
- flood 40° = 4

WW = LIGHT COLOUR

- LED 2700K = 23 CRI>90
- LED 3000K = 29 CRI>90
- LED 4000K = 24 CRI>90

XX = COLOUR

- grey = 04
- white = 05
- black = 06





Parkhotel, Graz, Austria, Photo: Joachim Rauch

VIBO

VIBO VOLARE

220-240V AC 50/60Hz Design: INHOUSE UGR<16

IP20 CE

Schienenstrahler aus Aluminium · Oberfläche pulverbeschichtet · Spezielle Linsenoptik ohne Streulicht · Dekoring Weiß oder Schwarz pulverbeschichtet
 Track spotlight in aluminium · surface powder-coated · Special lens optics without scattered light · decoration ring black or white powder-coated
 Faretto da binario in alluminio · verniciatura a polvere · Ottica speciale senza luce diffusa · anello decorativo verniciato a polvere in nero o bianco
 Projecteur sur rail en aluminium · vernissage à poudre · lentille optique sans lumière parasite · anneau décoratif laqué noir ou blanc

VIBO VOLARE DIMM

CODE	SYS W	LUMEN
668-00501RRWWXXY	8	340 - 470

dimmbar / dimmable

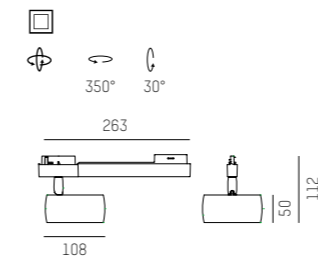

VIBO VOLARE

CODE	SYS W	LUMEN
668-00401RRWWXX0	8	340 - 470

nicht dimmbar / not dimmable

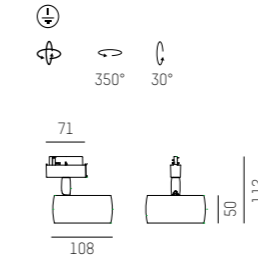

DEKORRING für 2 färbige Versionen
 DECOR RING for bi-coloured versions

CODE	FARBE COLOUR
668-000105	W
668-000106	S



DIMM



SWITCHABLE



COMPLETE CODE

RR = REFLECTOR	WW = LIGHT COLOUR	X = COLOUR ADAPTER	X = COLOUR LUMINAIRE	Y = DIMMABLE
<ul style="list-style-type: none"> 10° spot = 02 23° medium = 05 35° flood = 08 	<ul style="list-style-type: none"> W2 LED 2700K = 23 CRI>90 W3 LED 3000K = 29 CRI>90 W4 LED 4000K = 24 CRI>90 	<ul style="list-style-type: none"> 6 grey = 4 W white = 5 S black = 6 	<ul style="list-style-type: none"> W white = 5 S black = 6 	<ul style="list-style-type: none"> L LOXONE AIR dim = r B SMART BLUETOOTH dim = b C CASAMBI dim = c





Private residence, Austria, Photo: Joachim Rauch

LITIN 2 SPOT

LITIN 2 SPOT VOLARE

IP20

220-240V AC 50/60Hz Design: INHOUSE

Stromschienenstrahler aus Aluminium · Oberfläche pulverbeschichtet · mit satiniertem bündigem Diffusor aus PMMA oder mit Linsenoptik erhältlich
 Track spotlight in aluminium · surface powder-coated surface · available with satinized flush PMMA diffuser or with lens optics
 Proiettore da binario in alluminio · superficie verniciata a polvere · disponibile con diffusore a filo satinato in PMMA o con lente
 Spot pour rail en aluminium · surface thermolaquée · disponible avec un diffuseur affleurant satiné en PMMA ou avec une technologie de lentille

CODE	SYS W	LUMEN
540-051RRWWDDXXO	10	530 - 840

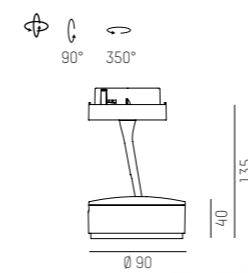

COMPLETE CODE				
RR = REFLECTOR	WW = LIGHT COLOUR	DD = DECORRING COLOUR	X = COLOUR ADAPTER	XX = COLOUR LUMINAIRE
opal diffusor = 10	LED 2700K = 13 CRI>90	white = 05	grey = 4	grey = 04
24° medium lens = 22	LED 3000K = 19 CRI>90	black = 06	white = 5	white = 05
40° flood lens = 23	LED 4000K = 14 CRI>90	gold = 1d	black = 6	black = 06
		copper = 1b		

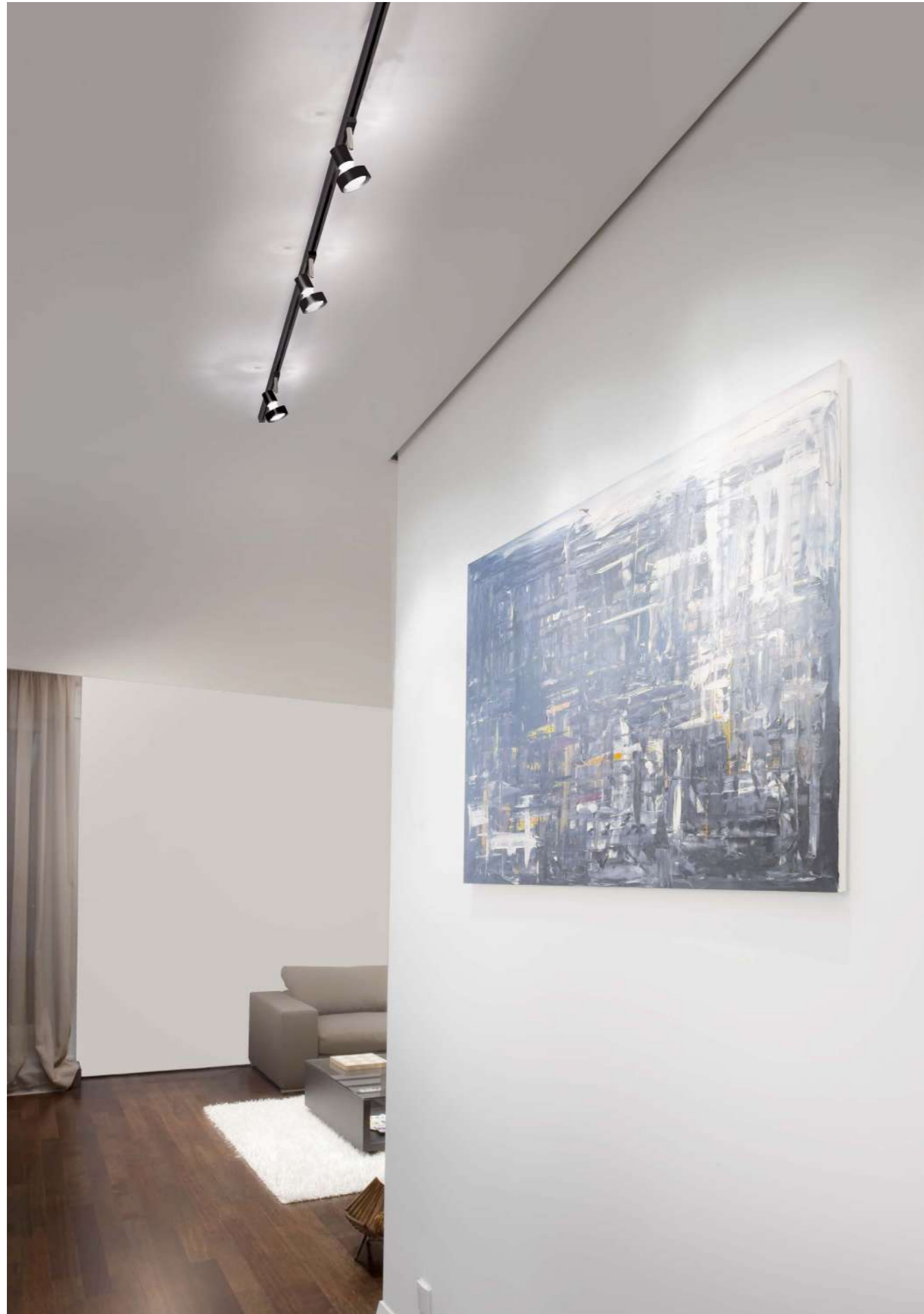

CONTE

CONTE VOLARE

220-240V AC

50/60Hz

QPAR 16/20 / GU10 / Retrofit max. 9W

Design: INHOUSE

IP20

Strahler aus Aluminium · Oberfläche in Weiß, Schwarz, Perlchrom oder Chrom · Leuchtenkopf 340° drehbar und 90° schwenkbar

Spotlight range made of aluminium · white, black, pearl chrome or chrome · spotlight head 340° swiveling and 90° tilting

Gamma faretti in alluminio · superficie bianca, nero, cromo satinato o cromo · testa proiettore girevole a 340° e inclinabile a 90°

Gamme des projecteurs en aluminium · superficie blanc, noir, chrome matt ou chrome · tête projecteur tournant à 340° et pivotant à 90°

CODE

659-00275000XX

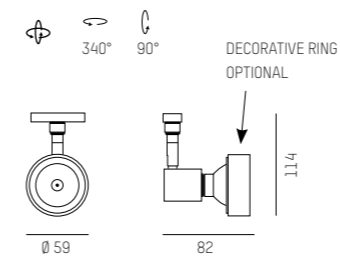

CONTE DEKORRING	FÜR	FARBE
CONTE DECORRING	FOR	COLOUR
659-000011	QPAR16	chrome
659-000012	QPAR16	pearl chrome
659-000015	QPAR16	white
659-000016	QPAR16	black

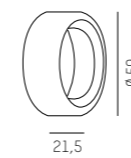

LEUCHTMITTEL 6W CRI>90

BULB 6W CRI>90

30-752517

30-707692

LICHTFARBE

COLOUR

2700K / 355lm

3000K / 375lm



COMPLETE CODE

XX = COLOUR

pearl chrome = 42

white = 55

black = 66



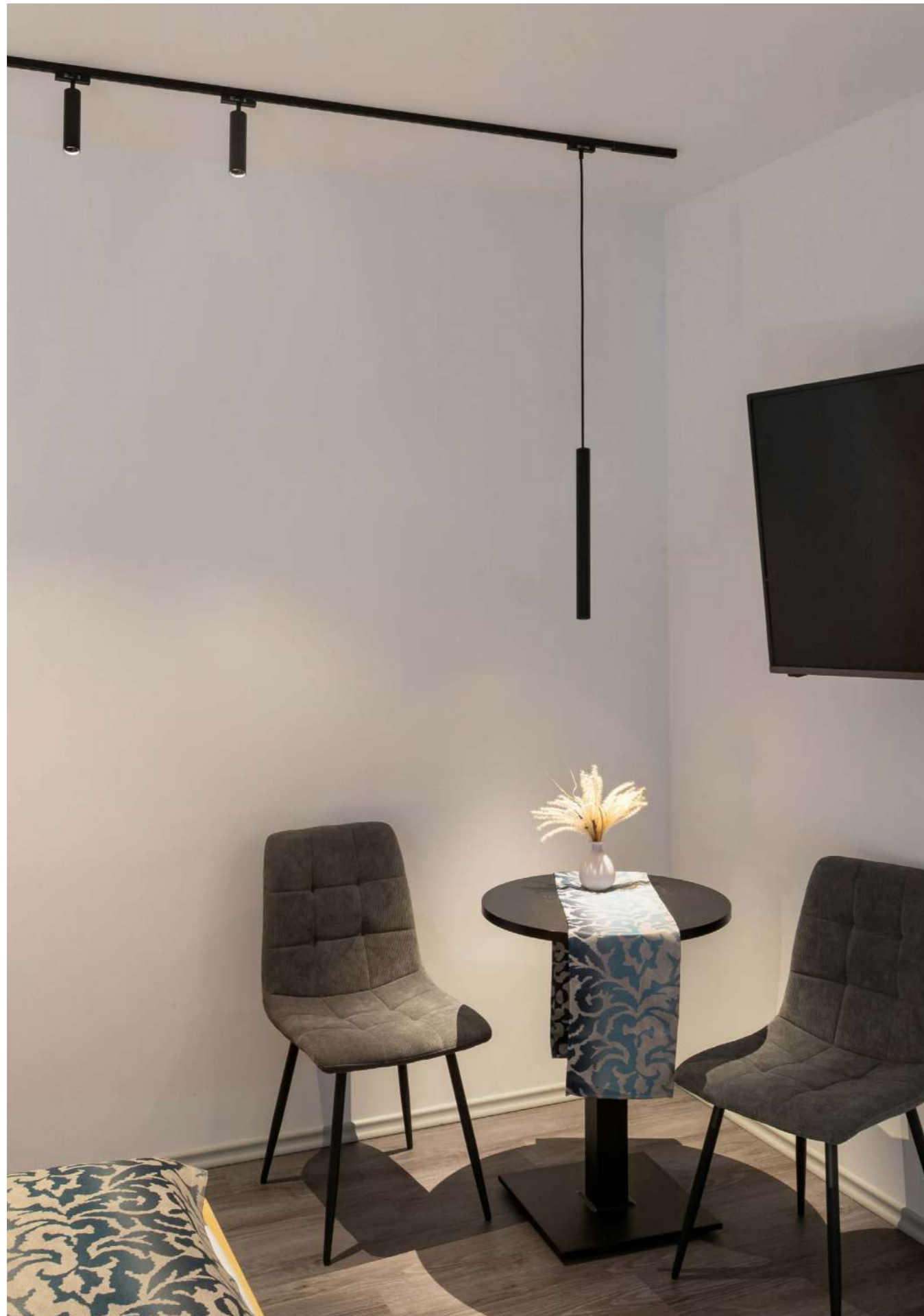

Hotel Lichtenauer, Aspang, Austria, Photo: Joachim Rauch

ROGGA PD

ROGGA PD VOLARE

220-240V AC 50/60Hz Design: INHOUSE

IP20

LED Pendelleuchte aus Aluminium · Oberfläche pulverbeschichtet · LED Konverter im Rohr integriert (AC Version) · Online konfigurierbar
 LED pendant in aluminium · surface powder-coated · LED converter integrated in the tube (AC version) · can be configured online
 Sospensione LED in alluminio · verniciatura a polveri · alimentatore LED integrato nell' tubo (AC versione) · configurabile online
 Suspensdue Projecteur LED en aluminium · vernissage à poudres · alimentation LED intégrée dans l'tube (AC version) · configurable en ligne

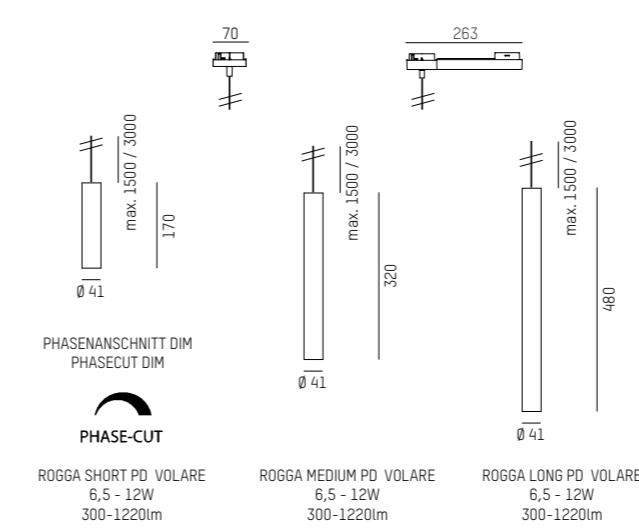

Optik / optics



Zubehör / accessories

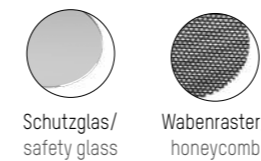

configurable





Liepert's Kulinarium Leutschach, Austria, Photo: Joachim Rauch

ROGGA PD

ROGGA SPHERE / TOP PD VOLARE

220-240V AC 50/60Hz Design: INHOUSE

IP20

LED Pendelleuchte aus Aluminium · Oberfläche pulverbeschichtet · LED Konverter im Rohr integriert (AC Version) · Online konfigurierbar
 LED pendant in aluminium · surface powder-coated · LED converter integrated in the tube (AC version) · can be configured online
 Sospensione LED in alluminio · verniciatura a polveri · alimentatore LED integrato nell' tubo (AC versione) · configurabile online
 Suspensie Projecteur LED en aluminium · vernissage à poudres · alimentation LED intégrée dans l'tube (AC version) · configurable en ligne

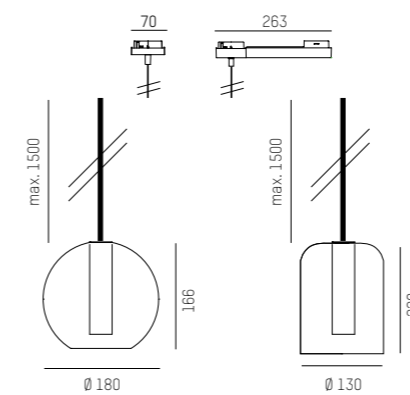

ROGGA SPHERE PD Volare
6,5 - 12W
300-1220lm

ROGGA TOP PD Volare
6,5 - 12W
300-1220lm

PHASENSCHNITT DIM
PHASECUT DIM



PHASE-CUT

Optik / optics

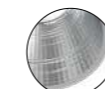

Reflektor/
reflector

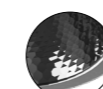

Dark Reflektor/
dark reflector



Linse/
lens



LFO
lens

Zubehör / accessories



Schutzglas/
safety glass

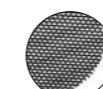

Wabenraster/
honeycomb



configurable





NCYAN Innovation für Menschen, St. Jakob, Austria, Photo: Joachim Rauch

DARK NIGHT XS

DARK NIGHT XS VOLARE

220-240V AC 50/60Hz Design: INHOUSE

IP20

LED Pendelleuchte aus Aluminium · Oberfläche pulverbeschichtet · Reflektor in 4 Farben erhältlich · inkl. 3000mm Abhängung
 LED pendant in aluminium · surface powder-coated · reflector available in 4 colours · incl. 3000mm suspension
 Sospensione LED in alluminio · verniciato a polvere in bianco o nero · Riflettore disponibile in 4 colori. Incl. 3000mm di sospensione
 Lampe suspendue LED en aluminium · vernissé à poudres · réflecteur disponible en 4 couleurs · avec 3000mm de suspension

CODE	SYS W	LUMEN
684-007RR0BWWXXY	16 - 17	1160 - 1290

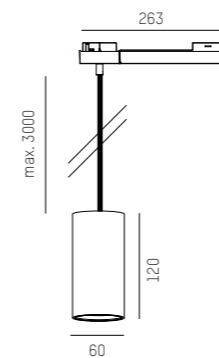

KABELHALTER / CABLE HOLDER

CODE

305-0001



Reflektorfarben / reflector colours



COMPLETE CODE						
RR = REFLECTOR	B = BEAM ANGLE	WW = LIGHT COLOUR	X = COLOUR ADAPTER	X = COLOUR LUMINAIRE	Y = DIMMABLE	
= 02	40° = 5	LED 2700K = 43 PREMIUM CRI>90	grey = 4	white = 5	switchable = 0	
= 03	60° = 8	LED 3000K = 49 PREMIUM CRI>90	white = 5	black = 6	LOXONE AIR dim = r	
= 04		LED 4000K = 24 CRI>90	black = 6		SMART BLUETOOTH dim = b	
= 06					CASAMBI dim = c	





DIVO

DIVO VOLARE

220-240V AC 50/60Hz Design: INHOUSE

IP20

Zylindrische LED Pendelleuchte · Leuchtenkörper erhältlich in zwei Längen · Oberfläche pulverbeschichtet · Ausstrahlwinkel 36°
 Cylindrical LED pendant luminaire · lamp body available in two lengths · surface powder-coated · beam angle 36°
 Lampada LED a sospensione di forma cilindrica · corpo lampada disponibile in due lunghezze · superficie verniciata a polveri · fascio d'apertura 36°
 Lampe suspensue cylindrique à LED · corps de lampe disponible en deux longueurs · vernissé à poudres · faisceau d'ouverture 36°

DIVO SHORT VOLARE

CODE	SYS W	LUMEN
192-209020002WXXY	12	680

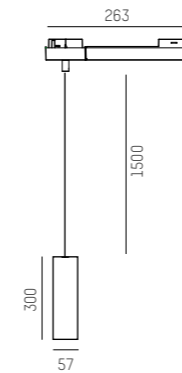

DIVO LONG VOLARE

CODE	SYS W	LUMEN
192-209030002WXXY	12	720

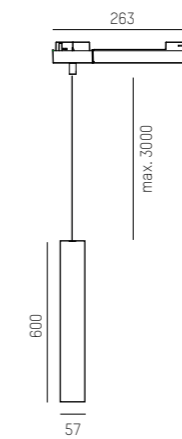

KABELHALTER / CABLE HOLDER

CODE

305-0001



SHORT



LONG



COMPLETE CODE

W = LIGHT COLOUR	X = COLOUR LUMINAIRE	X = COLOUR ADAPTER	Y = DIMMABLE
W2 LED 2700K = 3 CRI>90	W white = 5	G grey = 4	S switchable = 0
W3 LED 3000K = 9 CRI>90	S black = 6	W white = 5	L LOXONE AIR dim = r
		S black = 6	B SMART BLUETOOTH dim = b
			C CASAMBI dim = c



Molto Luce Showroom, Munich, Germany, Photo: Joachim Rauch

LITIN 2 PD

LITIN 2 PD VOLARE

220-240V AC

50/60Hz

Design: INHOUSE

IP20

LED Pendelleuchte · aus Aluminium · Oberfläche pulverbeschichtet · mit satiniertem bündigem Diffusor aus PMMA oder mit Linsenoptik erhältlich
 LED pendant in aluminium · surface powder-coated surface · available with satined flush PMMA diffuser or with lens optics
 Sospensione LED in alluminio · superficie verniciata a polvere · disponibile con diffusore a filo satinato in PMMA o con lente
 Suspension LED en aluminium · surface thermolaquée · disponible avec un diffuseur affleurant satiné en PMMA ou avec une technologie de lentille

CODE	SYS W	LUMEN
540-021RRWWDDXXX0	10	530 - 840

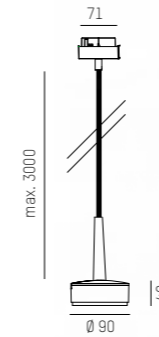

KABELHALTER / CABLE HOLDER

CODE

305-0001



COMPLETE CODE

RR = REFLECTOR	WW = LIGHT COLOUR	DD = DECORRING COLOUR	X = COLOUR ADAPTER	XX = COLOUR LUMINAIRE
opal diffuser = 10	LED 2700K = 13 CRI>90	white = 05	grey = 4	grey = 04
24° medium lens = 22	LED 3000K = 19 CRI>90	black = 06	white = 5	white = 05
40° flood lens = 23	LED 4000K = 14 CRI>90	gold = 1d	black = 6	black = 06
		copper = 1b		



Honkey Distillery, Rohrbach-Berg, Austria, Photo: Joachim Rauch

LOON

LOON VOLARE

220-240V AC

50/60Hz

Design: INHOUSE

IP20

Dekorative designreduzierte Hängeleuchte · Hochwertig gearbeitete Lampenfassung E27 aus Aluminium · Inkl. 2500mm Kabel in Schwarz oder Weiß
 Decorative design reduced pendant · high quality lamp socket E27 made of aluminium · Incl. 2500mm cable in black or white
 Lampada decorativa a sospensione · portalampada di alta qualità E27 in alluminio · cavo da 2500mm in bianco o nero incluso
 Lampe décorative suspendue · douille en aluminium E27 de haute qualité · câble noir ou blanc de 2500 mm inclus

CODE

636-029000X000X00

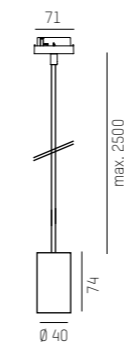

KABELHALTER / CABLE HOLDER

CODE

305-0001



COMPLETE CODE

X = COLOUR ADAPTER

grey = 4
 white = 5
 black = 6

X = COLOUR LUMINAIRE

white = 5
 black = 6



Katharinen Apotheke, Freistadt, Austria, Photo: Joachim Rauch

LOON MINI BALL

LOON MINI VOLARE / LOON MINI BALL VOLARE

220-240V AC 50/60Hz Design: INHOUSE D45 / E14 / Retrofit max. 4W

IP20

Dekorative Hängeleuchte im Retro-Design · hochwertige Glaskugel mundgeblasen in 3 Farben · speziell konstruierte Fassung für bündige Montage
 Decorative suspended luminaire in retro design · high-quality blown glass ball in 3 different colours · special socket construction for flush mounting
 Sospensione con design decorativo · sfera di vetro soffiato in 3 colori differenti · portalampada speciale per montaggio a filo
 Suspension decorative · boule en verre soufflé 3 couleurs au choix · douille de lampe spéciale.

LOON MINI VOLARE

CODE
636-019000X000600

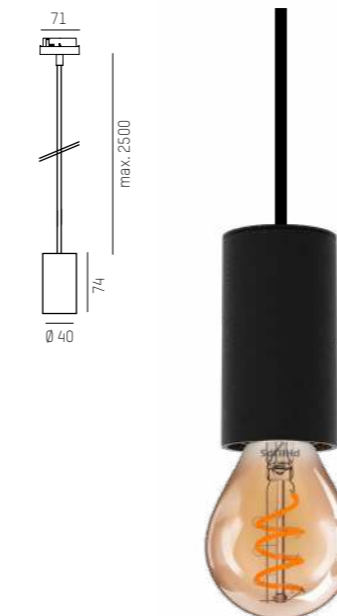

LOON MINI BALL VOLARE

CODE	GLASS
636-019111X000600	
636-019112X000600	
636-019113X000600	



KABELHALTER / CABLE HOLDER

CODE
305-0001



LOON MINI



LOON MINI BALL



COMPLETE CODE FOR ADAPTER		
X = COLOUR		
grey = 4	white = 5	black = 6



Private residence, Austria, Planing: Ben Elmecker, Photo: Martin Pröll

CORPA

CORPA VOLARE

220-240V AC 50/60Hz Design: Rainer Mutsch QPAR 16 / GU10 / Retrofit max. 9W

IP20

Dekorative Hängeleuchte · Oberfläche schwarz pulverbeschichtet · kombinierbar mit 3 verschiedenen mundgeblasenen Gläsern
 Decorative pendant lamp · surface black powder-coated · can be combined with 3 different mouth-blown glasses
 Lampada decorativa a sospensione · verniciato a polveri in nero · combinabile con 3 diversi vetri soffiati
 Lampe décorative suspendue · vernissé à poudres en noir · combinable avec 3 verres soufflés

CORPA IRIS S VOLARE

CODE	GLASS
257-029111X000600	
257-029112X000600	
257-029113X000600	

CORPA IRIS L VOLARE

CODE	GLASS
257-029121X000600	
257-029122X000600	
257-029123X000600	

CORPA BASS VOLARE

CODE	GLASS
257-029131X000600	
257-029133X000600	

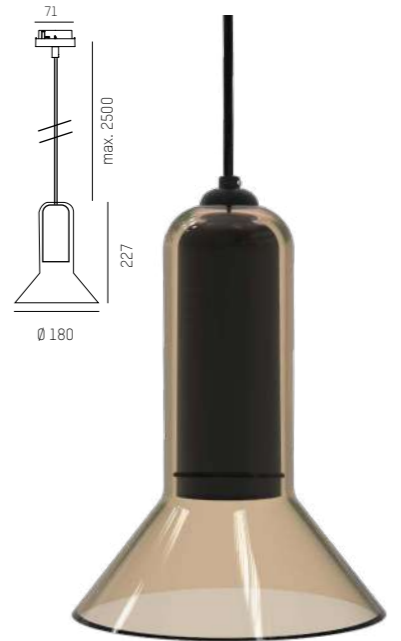
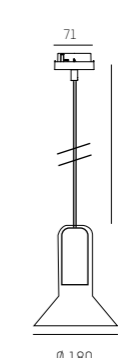
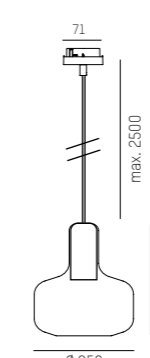
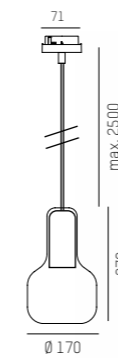

KABELHALTER / CABLE HOLDER

CODE

305-0001



CORPA IRIS S



CORPA IRIS L



CORPA BASS



LEUCHTMITTEL 6W CRI>90

BULB 6W CRI>90

30-752517

30-707692

LICHTFARBE

COLOUR

2700K / 355lm

3000K / 375lm



COMPLETE CODE FOR ADAPTER

X = COLOUR

grey = 4

white = 5

black = 6



COCKTAIL

COCKTAIL VOLARE

IP20

220-240V AC 50/60Hz Design: Klaus Nolting

Dekorative Hängeleuchte · Oberfläche schwarz pulverbeschichtet · kombinierbar mit 3 verschiedenen mundgeblasenen Gläsern
 Decorative pendant lamp · surface black powder-coated · can be combined with 3 different mouth-blown glasses
 Lampada decorativa a sospensione · verniciato a polveri in nero · combinabile con 3 diversi vetri soffiati
 Lampe décorative suspendue · vernissé à poudres en noir · combinable avec 3 verres soufflés

COCKTAIL S VOLARE

CODE	SYS W	LUMEN
110-01911XX00W60Y	10	250 - 300

COCKTAIL M VOLARE

CODE	SYS W	LUMEN
110-01912XX00W60Y	10	250 - 300

COCKTAIL L VOLARE

CODE	SYS W	LUMEN
110-01913XX00W60Y	10	250 - 300



KABELHALTER / CABLE HOLDER

CODE

305-0001



COCKTAIL S



COCKTAIL M



COCKTAIL L



COMPLETE CODE																											
W = LIGHT COLOUR	X = COLOUR GLASS	X = COLOUR ADAPTER	Y = DIMMABLE																								
<table border="0"> <tr> <td>W2</td> <td>LED 2700K = 3 CRI>90</td> </tr> <tr> <td>W3</td> <td>LED 3000K = 9 CRI>90</td> </tr> </table>	W2	LED 2700K = 3 CRI>90	W3	LED 3000K = 9 CRI>90	<table border="0"> <tr> <td>S6</td> <td>smoked grey = 1</td> </tr> <tr> <td>B</td> <td>brown = 2</td> </tr> <tr> <td>V</td> <td>violett = 3</td> </tr> </table>	S6	smoked grey = 1	B	brown = 2	V	violett = 3	<table border="0"> <tr> <td>G</td> <td>grey = 4</td> </tr> <tr> <td>W</td> <td>white = 5</td> </tr> <tr> <td>S</td> <td>black = 6</td> </tr> </table>	G	grey = 4	W	white = 5	S	black = 6	<table border="0"> <tr> <td>S</td> <td>switchable = 0</td> </tr> <tr> <td>L</td> <td>LOXONE AIR dim = r</td> </tr> <tr> <td>B</td> <td>SMART BLUETOOTH dim = b</td> </tr> <tr> <td>C</td> <td>CASAMBI dim = c</td> </tr> </table>	S	switchable = 0	L	LOXONE AIR dim = r	B	SMART BLUETOOTH dim = b	C	CASAMBI dim = c
W2	LED 2700K = 3 CRI>90																										
W3	LED 3000K = 9 CRI>90																										
S6	smoked grey = 1																										
B	brown = 2																										
V	violett = 3																										
G	grey = 4																										
W	white = 5																										
S	black = 6																										
S	switchable = 0																										
L	LOXONE AIR dim = r																										
B	SMART BLUETOOTH dim = b																										
C	CASAMBI dim = c																										



WIZARD

WIZARD VOLARE

220-240V AC 50/60Hz A60/E27 max. 45W Design: Serge & Robert Cornelissen

IP20

Hängeleuchte mit E27-Fassung · Frei schwenkbarer Schirm aus Aluminium · Lichtstimmung durch direkten und indirekten Lichtaustritt
 Suspension with E27 socket · flexible adjustable shade made of aluminium · lighting mood through direct and indirect light emission
 Sospensione con portalampana E27 · paralume flessibile e regolabile in alluminio · emissione luminosa diretta ed indiretta
 Suspension avec douille E27 · abat-jour en aluminium thermolaquée réglable de manière flexible · directe et indirecte de la lumière

WIZARD M VOLARE

CODE
114-0191000WXY500

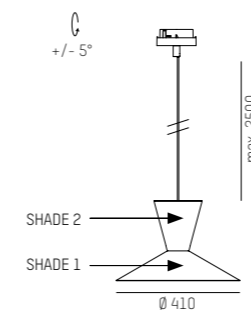

WIZARD L VOLARE

CODE
114-0291000WXY500

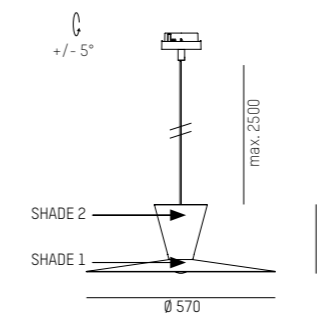

KABELHALTER / CABLE HOLDER

CODE
305-0001



WIZARD M



WIZARD L



COMPLETE CODE		
W = COLOUR ADAPTER	X = COLOUR SHADE 1	Y = COLOUR SHADE 2
grey = 4	white = 5	white = 5
white = 5	black = 6	black = 6
black = 6	gold = 7	gold = 7
	copper = 8	copper = 8



La Sonett, Gmunden, Austria, Photo: Joachim Rauch

V-LINE

V-LINE VOLARE

220-240V AC

50/60Hz

Design: INHOUSE

IP20

Stromschienenleuchte aus stranggepresstem Aluprofil · Oberfläche pulverbeschichtet · LED Konverter im Leuchtenprofil integriert
 Track luminaire · extruded aluminium profile · surface powder-coated · with LED converter in profile
 Lampada in alluminio estruso per binario · verniciato a polvere · converter LED integrato nel profilo estruso
 Luminaire sur rail en aluminium extrudé · vernissage à poudres · convertiseur intégré dans le profil

V-LINE VOLARE DIMM

CODE	SYS W	LUMEN
694-1100110 WWXXY	9	580 - 660

dimmbar / dimmable

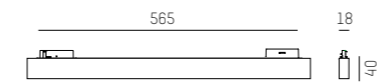

V-LINE VOLARE

CODE	SYS W	LUMEN
694-1100210 WWXX0	11	730 - 820

nicht dimmbar / not dimmable

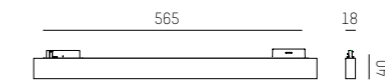

DEMONTAGEWERKZEUG / REMOVAL TOOL

652-0000100000

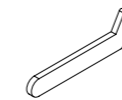
für V-Line Leuchten
for V-Line luminaires

COMPLETE CODE

WW = LIGHT COLOUR	XX = COLOUR LUMINAIRE	Y = DIMMABLE																
<table border="1"> <tr> <td>W2</td> <td>LED 2700K = 23 CRI>90</td> </tr> <tr> <td>W3</td> <td>LED 3000K = 29 CRI>90</td> </tr> <tr> <td>W4</td> <td>LED 4000K = 24 CRI>90</td> </tr> </table>	W2	LED 2700K = 23 CRI>90	W3	LED 3000K = 29 CRI>90	W4	LED 4000K = 24 CRI>90	<table border="1"> <tr> <td>W</td> <td>white = 05</td> </tr> <tr> <td>S</td> <td>black = 06</td> </tr> </table>	W	white = 05	S	black = 06	<table border="1"> <tr> <td>Ⓐ</td> <td>LOXONE AIR dim = r</td> </tr> <tr> <td>Ⓑ</td> <td>SMART BLUETOOTH dim = b</td> </tr> <tr> <td>Ⓒ</td> <td>CASAMBI dim = c</td> </tr> </table>	Ⓐ	LOXONE AIR dim = r	Ⓑ	SMART BLUETOOTH dim = b	Ⓒ	CASAMBI dim = c
W2	LED 2700K = 23 CRI>90																	
W3	LED 3000K = 29 CRI>90																	
W4	LED 4000K = 24 CRI>90																	
W	white = 05																	
S	black = 06																	
Ⓐ	LOXONE AIR dim = r																	
Ⓑ	SMART BLUETOOTH dim = b																	
Ⓒ	CASAMBI dim = c																	



LITIN 2



STYLISH ACCENTS WITH ELEGANT DESIGN

LITIN ist eine formschöne und variantenreiche Leuchtenfamilie aus Aluminium. Die pulverbeschichtete Oberfläche ist in den Farben Schwarz und Weiß erhältlich. Mit einem Dekorring in Gold, Bronze, Weiß oder Schwarz lassen sich stilvolle Akzente setzen. Zwei unterschiedliche Ausstrahlwinkel sowie ein satiniertes bündiges Diffusor oder mit Linsenoptik schaffen ein perfektes Lichtbild. Der Leuchtenkopf ist bis zu 350° drehbar und 90° schwenkbar.

LITIN is an elegant and varied luminaire range made of aluminium. The powder-coated surface is available in black and white. A decorative ring of gold, bronze, white or black adds a stylish touch. Two different beam angles as well as a glossy flush diffuser or lens optic create the perfect brightness. The luminaire head can swivel to 350° and tilt to 90°.

Design: INHOUSE

VARIATIONS

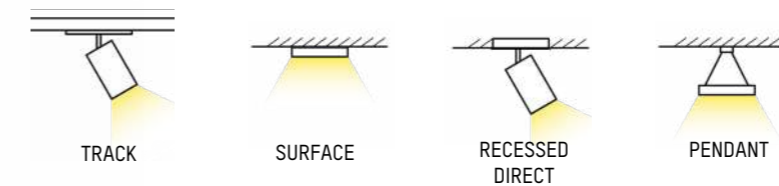

CORE COLOURS

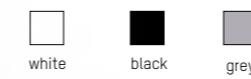

CREATIVE COLOURS

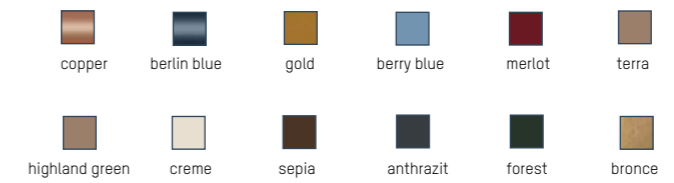

OPTICS

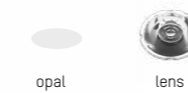

LED COLOURS





Der Schrenk, Passail, Austria, Photo: Joachim Rauch

LITIN 2

LITIN 2 TRACK

220-240V AC 50/60Hz Design: INHOUSE

IP20

Stromschienenstrahler aus Aluminium · Oberfläche pulverbeschichtet · mit satiniertem bündigem Diffusor aus PMMA oder mit Linsenoptik erhältlich
 Track spotlight in aluminium · surface powder-coated surface · available with satined flush PMMA diffuser or with lens optics
 Proiettore da binario in alluminio · superficie verniciata a polvere · disponibile con diffusore a filo satinato in PMMA o con lente
 Spot pour rail en aluminium · surface thermolaquée · disponible avec un diffuseur affleurant satiné en PMMA ou avec une technologie de lentille

CODE	SYS W	LUMEN
540-061RRWWDDXXX0	10	530 - 840

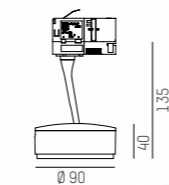
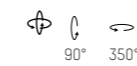

COMPLETE CODE			
RR = REFLECTOR	WW = LIGHT COLOUR	DD = DECORRING COLOUR	XXX = COLOUR LUMINAIRE
<ul style="list-style-type: none"> opal diffusor = 10 24° medium lens = 22 40° flood lens = 23 	<ul style="list-style-type: none"> LED 2700K = 13 CRI>90 LED 3000K = 19 CRI>90 LED 4000K = 14 CRI>90 	<ul style="list-style-type: none"> grey = 04 white = 05 black = 06 gold = 1d copper = 1b 	<ul style="list-style-type: none"> grey = 404 white = 505 black = 606



Light & Building fair stand, Frankfurt, Germany, Photo: Joachim Rauch

LITIN 2

LITIN 2 PD

220-240V AC

50/60Hz

Design: INHOUSE

IP20

Pendelleuchte aus Aluminium · Oberfläche pulverbeschichtet · mit satiniertem bündigem Diffusor aus PMMA oder mit Linsenoptik erhältlich
 Pendant in aluminium · surface powder-coated surface · available with satined flush PMMA diffuser or with lens optics
 Sospensione in alluminio · superficie verniciata a polvere · disponibile con diffusore a filo satinato in PMMA o con lente
 Suspension en aluminium · surface thermolaquée · disponible avec un diffuseur affleurant satiné en PMMA ou avec une technologie de lentille

CODE	SYS W	LUMEN
540-041RRWWDDXXX0	10	530 - 840

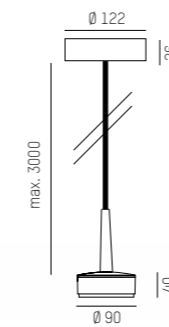

KABELHALTER / CABLE HOLDER

CODE

305-0001



COMPLETE CODE

RR = REFLECTOR	WW = LIGHT COLOUR	DD = DECORRING COLOUR	XXX = COLOUR LUMINAIRE
opal diffuser = 10	LED 2700K = 13 CRI>90	grey = 04	grey = 404
24° medium lens = 22	LED 3000K = 19 CRI>90	white = 05	white = 505
40° flood lens = 23	LED 4000K = 14 CRI>90	black = 06	black = 606
		gold = 1d	
		copper = 1b	





LITIN 2

LITIN 2 SD

220-240V AC

50/60Hz

Design: INHOUSE

IP20

Deckenaufbauleuchte aus Aluminium · Oberfläche pulverbeschichtet · mit satiniertem bündigem Diffusor aus PMMA oder mit Linsenoptik erhältlich
 Surface mounted ceiling luminaire in aluminium · surface powder-coated surface · available with satined flush PMMA diffuser or with lens optics
 Lampada a plafone in alluminio · superficie verniciata a polvere · disponibile con diffusore a filo satinato in PMMA o con lente
 Plafonnier en aluminium · surface thermolaquée · disponible avec un diffuseur affleurant satiné en PMMA ou avec une technologie de lentille

CODE	SYS W	LUMEN
540-011RRWWDDXXX0	10	530 - 840

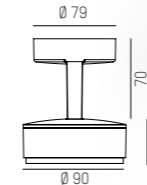

COMPLETE CODE

RR = REFLECTOR	WW = LIGHT COLOUR	DD = DECORRING COLOUR	XXX = COLOUR LUMINAIRE
opal diffuser = 10	LED 2700K = 13 CRI>90	grey = 04	grey = 404
24° medium lens = 22	LED 3000K = 19 CRI>90	white = 05	white = 505
40° flood lens = 23	LED 4000K = 14 CRI>90	black = 06	black = 606
		gold = 1d	
		copper = 1b	



LITIN 2

LITIN 2 R

220-240V AC

50/60Hz

Design: INHOUSE

IP20

Deckeneinbauleuchte aus Aluminium · Oberfläche pulverbeschichtet · mit satiniertem bündigem Diffusor aus PMMA oder mit Linsenoptik erhältlich
 Recessed mounted ceiling luminaire in aluminium · surface powder-coated surface · available with satinised flush PMMA diffuser or with lens optics
 Lampada ad incasso in alluminio · superficie verniciata a polvere · disponibile con diffusore a filo satinato in PMMA o con lente
 Eencasté pour plafond en aluminium · surface thermolaquée · disponible avec un diffuseur affleurant satiné en PMMA ou avec une technologie de lentille

CODE	SYS W	LUMEN
540-071RRWWDDXXX0	10	530 - 840

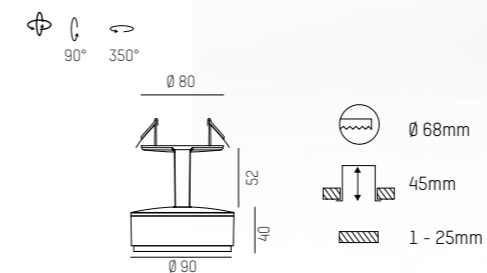

COMPLETE CODE

RR = REFLECTOR	WW = LIGHT COLOUR	DD = DECORRING COLOUR	XXX = COLOUR LUMINAIRE
<ul style="list-style-type: none"> opal diffusor = 10 24° medium lens = 22 40° flood lens = 23 	<ul style="list-style-type: none"> LED 2700K = 13 CRI>90 LED 3000K = 19 CRI>90 LED 4000K = 14 CRI>90 	<ul style="list-style-type: none"> grey = 04 white = 05 black = 06 gold = 1d copper = 1b 	<ul style="list-style-type: none"> grey = 404 white = 505 black = 606





ROGGA



Glanzer Homes, Längenfeld, Austria, Photo: hochundquerformat



Private residence, Austria, Photo: Joachim Rauch

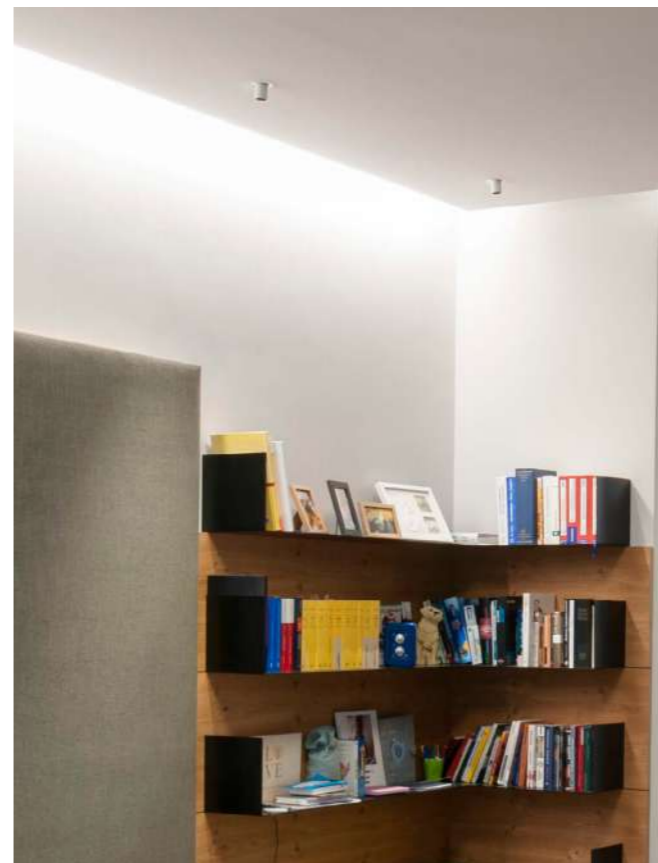

Private residence, Austria, Photo: Joachim Rauch

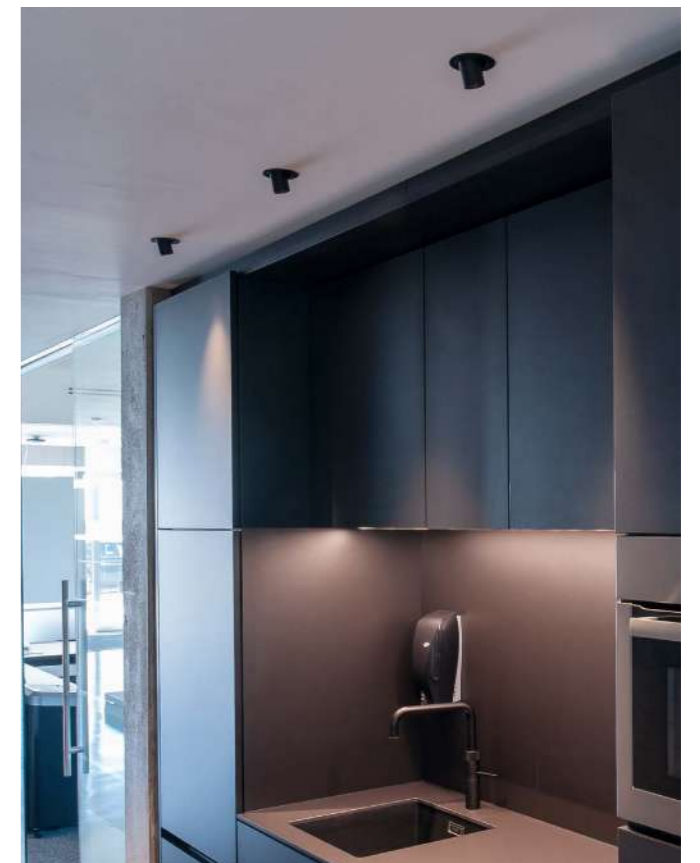

Hopferwieser und Steinmayr, Amstetten, Austria, Photo: Joachim Rauch

ROGGA



Light & Building Stand
Frankfurt, Germany
Photo: Joachim Rauch

ELGANCE MEETS SOPHISTICATED TECHNOLOGY

Die vielfältige Strahler-Serie ROGGA entspricht einer innovativen Fusion aus Eleganz und Modularität. Mit dem zeitlos geradlinigen Design und einer bemerkenswerten Funktionalität setzt ROGGA neue Maßstäbe. Dank der FULL-X-Change-Technologie können sowohl LED, 3-Phasen-Schienenadapter und Optiken werkzeuglos getauscht werden. Zusätzlich können diverse optische Accessoires wie Wabenraster oder Schutzglas werkzeuglos im Nachgang ergänzt werden. Dies bietet ein Höchstmaß an Flexibilität und Anpassungsfähigkeit. Die Produktfamilie von ROGGA besticht durch eine Vielfalt, die seinesgleichen sucht, setzt ein klares Statement im Raum, fügt sich aber dennoch immer harmonisch in die jeweilige Umgebungsarchitektur ein.

The ROGGA spotlight series represents an innovative fusion of elegance and modularity. With its timeless, linear design and remarkable functionality, ROGGA sets new standards. Thanks to FULL-X-Change technology, both LEDs, 3-phase track adapters, and optics can be replaced without tools. Additionally, various optical accessories such as honeycomb grids or protective glass can be added later without tools. This offers the highest level of flexibility and adaptability. The ROGGA product family stands out with an unparalleled variety, making a clear statement in any space while always harmonizing with the surrounding architecture.

Design: INHOUSE

VARIATIONS

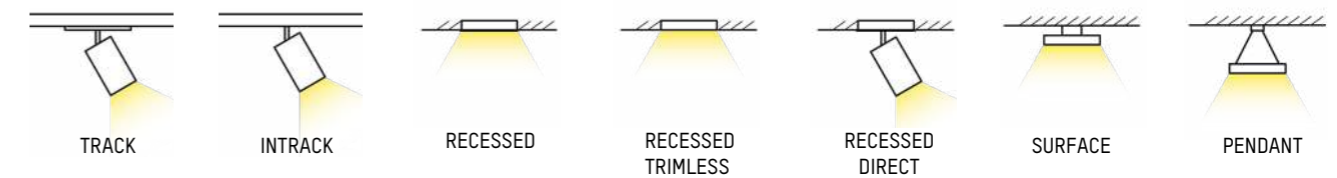

CORE COLOURS

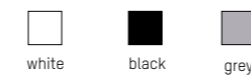

CREATIVE COLOURS

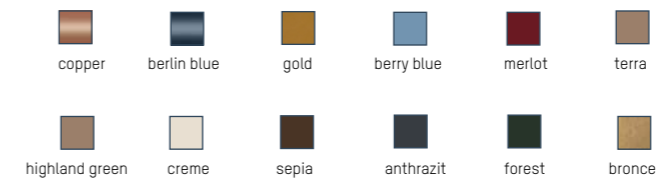

ANODIZED



OPTICS

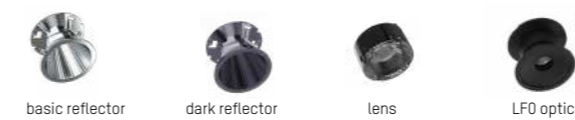

ACCESSOIRES



LED COLOURS

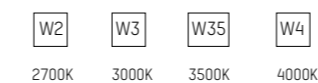

POWER & LUMEN

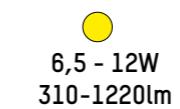

SPECIALS

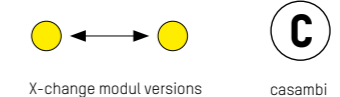

ROGGA TRACK

350° 110°



ROGGA S TRACK



ROGGA M TRACK



ROGGA S X-CHANGE TRACK



ROGGA M X-CHANGE TRACK

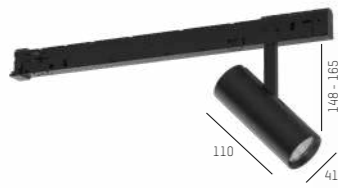

ROGGA S INTRACK



ROGGA M INTRACK



ROGGA VOLARE VERSIONS
see page: 166-167

ROGGA PD

ROGGA PD MOUNTING OPTIONS

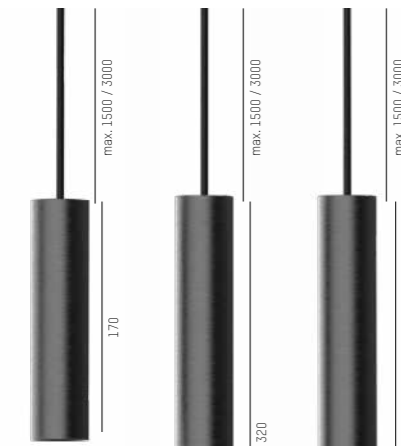

ROGGA S PD



ROGGA SPHERE PD



ROGGA M PD

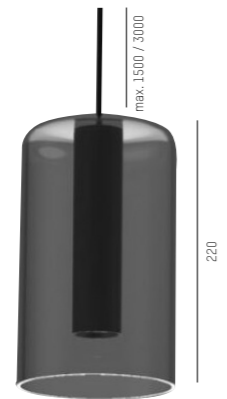

ROGGA TOP PD



surface



recessed
for easy click system
housing



recessed
for cutout \varnothing 68mm



track



ROGGA PD VOLARE VERSIONS
see page: 182-185

ROGGA R



ROGGA R
for easy click system
housing



ROGGA R
for cutout \varnothing 68mm

HOUSING WITH TRIM
easy click system

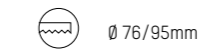

HOUSING TRIMLESS
easy click system



ROGGA TURN R
for easy click system
housing



ROGGA TURN S RD
for easy click system
housing



ROGGA TURN M RD
for easy click system
housing

ROGGA SD

350° 110°

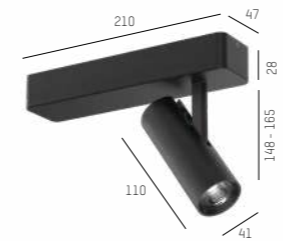

ROGGA S SD 1 FLAME

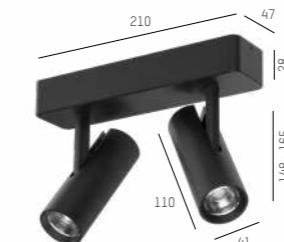

ROGGA S SD 2 FLAME

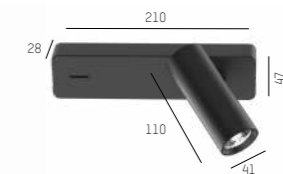

ROGGA S W
with switch

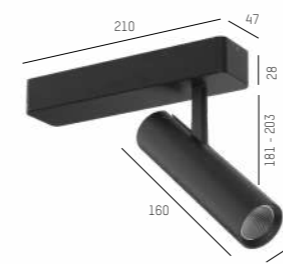

ROGGA M SD 1 FLAME



ROGGA M SD 2 FLAME

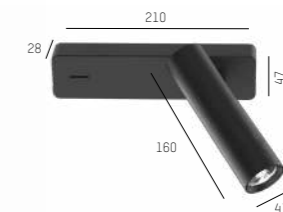

ROGGA M W
with switch

ROGGA OVERVIEW



Hotel Adebar, Dingolfing, Germany, Photo: Joachim Rauch



REFLECTOR CHROME

REFLECTOR DARK

LENS

LFO

BEAM ANGLES
 Superspot 12°
 Spot 17°
 Medium 24°
 Flood 50°

BEAM ANGLES
 Flood 50°

BEAM ANGLES
 Spot 17°
 Medium 30°
 Flood 50°

BEAM ANGLES
 Medium 30°
 Flood 50°



ACCESSOIRES (NOT FOR LFO)

Honeycomb
 Spread lens horizontal or vertical
 Protection glass

ROGGA OPTICS

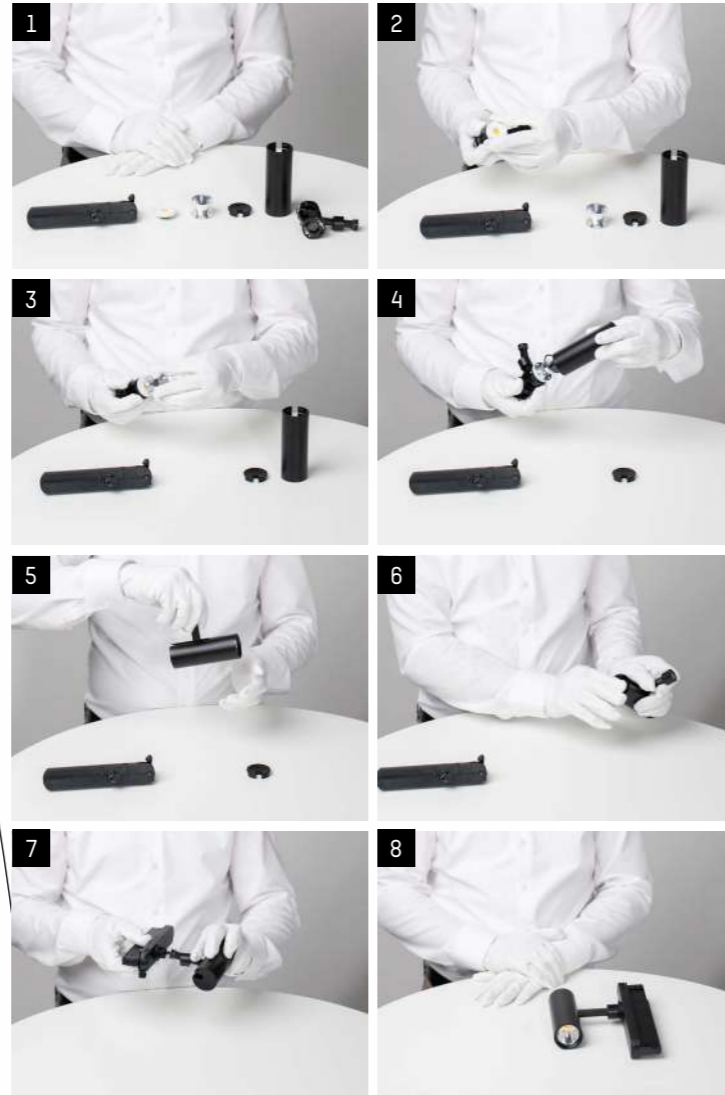

ROGGA FULL-X-Change ist dank der Molto Luce X-Change Technology modular aufgebaut, sodass einzelne Komponenten wie die Lichtquelle (COB-Modul), 3-Phasen-Schienen-Adapter, Optik, Schutzglas oder Wabenraster problemlos ausgetauscht werden können. Dies bietet mehr Flexibilität, Energieeffizienz und Nachhaltigkeit und erhöht die Lebensdauer der Produkte maßgeblich.

ROGGA FULL-X-Change is modular, thanks to Molto Luce X-Change Technology, allowing individual components such as the light source (COB module), 3-phase track adapter, optics, protective glass, or honeycomb grids to be easily replaced. This provides greater flexibility, energy efficiency, and sustainability, significantly extending the products' lifespan.



ROGGA X-CHANGE

Core Colours.

Die Farben Schwarz, Weiß und Grau bestimmen unser Kernsortiment.
The colours black, white and grey define our core range.



Creative Colours.

Ob Beerenblau, Merlot oder Hochlandgrün...
Das Rohr der Rogga Produktfamilie in Creative Colours harmonieren perfekt mit den Farben der modernen Architektur.

Be it Berryblue, Merlot or Highlandgreen...
The tube of the Rogga product family in Creative Colours harmonise perfectly with the colours of modern architecture.



Anodized.

Darüber hinaus ist das Rohr der Rogga Serie in den eloxierten Oberflächen champagner oder schiefer konfigurierbar.

Additionally, the tube of the Rogga series can be configured in the anodized finishes of champagne or slate.



ROGGA COLOURS

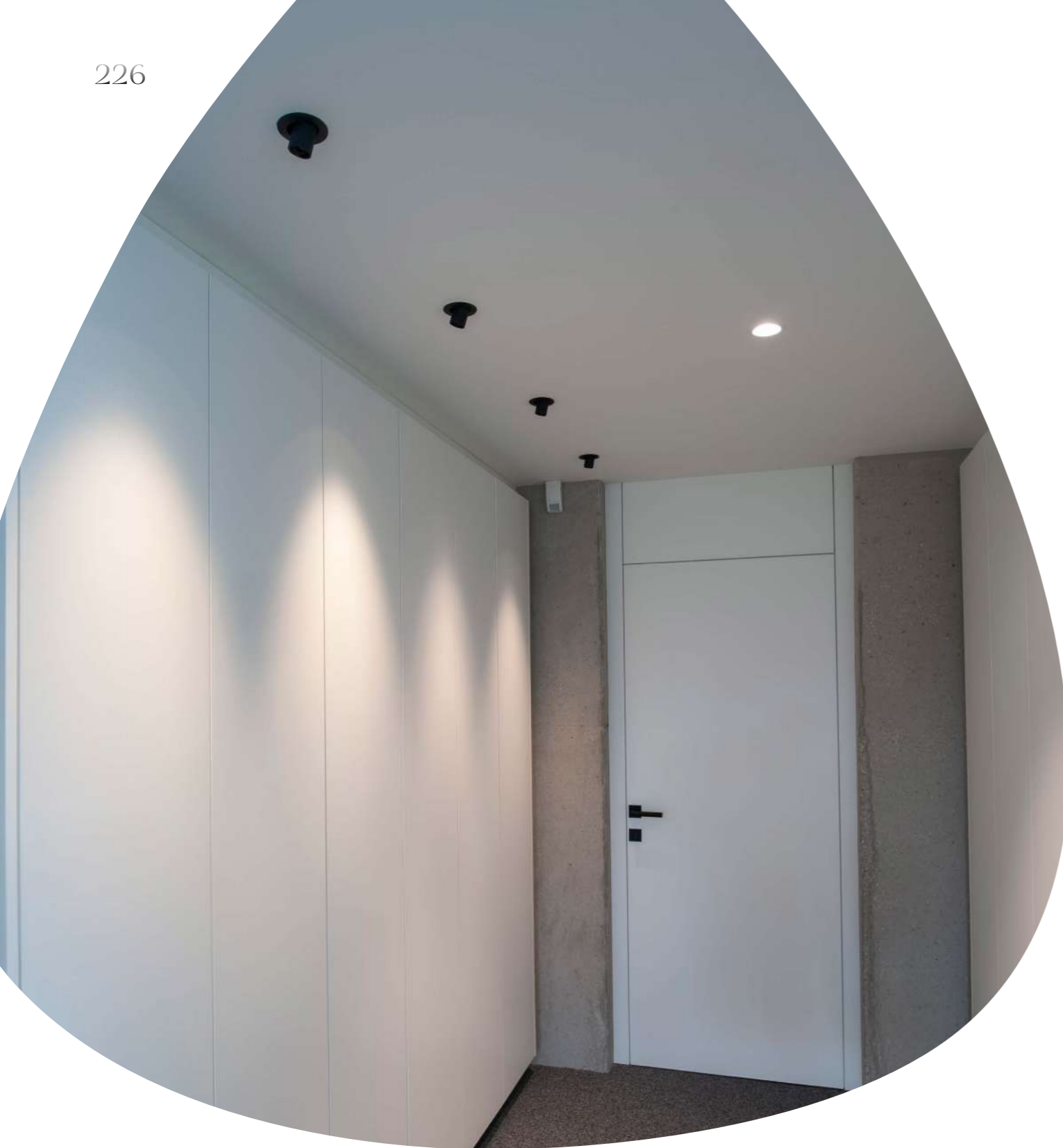

MOUNTING INSTRUCTIONS



Deckenloch ausschneiden und Einbaurahmen mittels höhenverstellbaren Halteklammern fixieren. Konverter bei vorgesehener Ausnehmung des Einbaurahmens in die Decke einlegen.

Cut a ceiling hole and fix the recessed frame using height-adjustable retaining clips. Insert the converter into the ceiling at the designated recess of the recessed frame.



Decke spachteln und malen. Vor dem Einbau des Strahlers Malerschutz abnehmen.

Fill and paint the ceiling. Remove the paint protection before installing the spotlight.



ROGGA R am Konverter anschließen und die Absturzsicherung am Strahlergehäuse einhängen.

ROGGA R with the converter and attach the strain relief to the spotlight housing.



Strahler in die Führungsschienen des Gehäuses einsetzen und werkzeuglos mittels Federtechnologie in das Gehäuse einklicken. Die Demontage erfolgt durch leichtes Drücken des Strahlers rein in die Decke – dadurch entriegelt sich der Federmechanismus.

Insert the spotlight into the guide rails of the housing and click it into place tool-free using spring technology. To remove, gently press the spotlight further into the ceiling to unlock the spring mechanism.

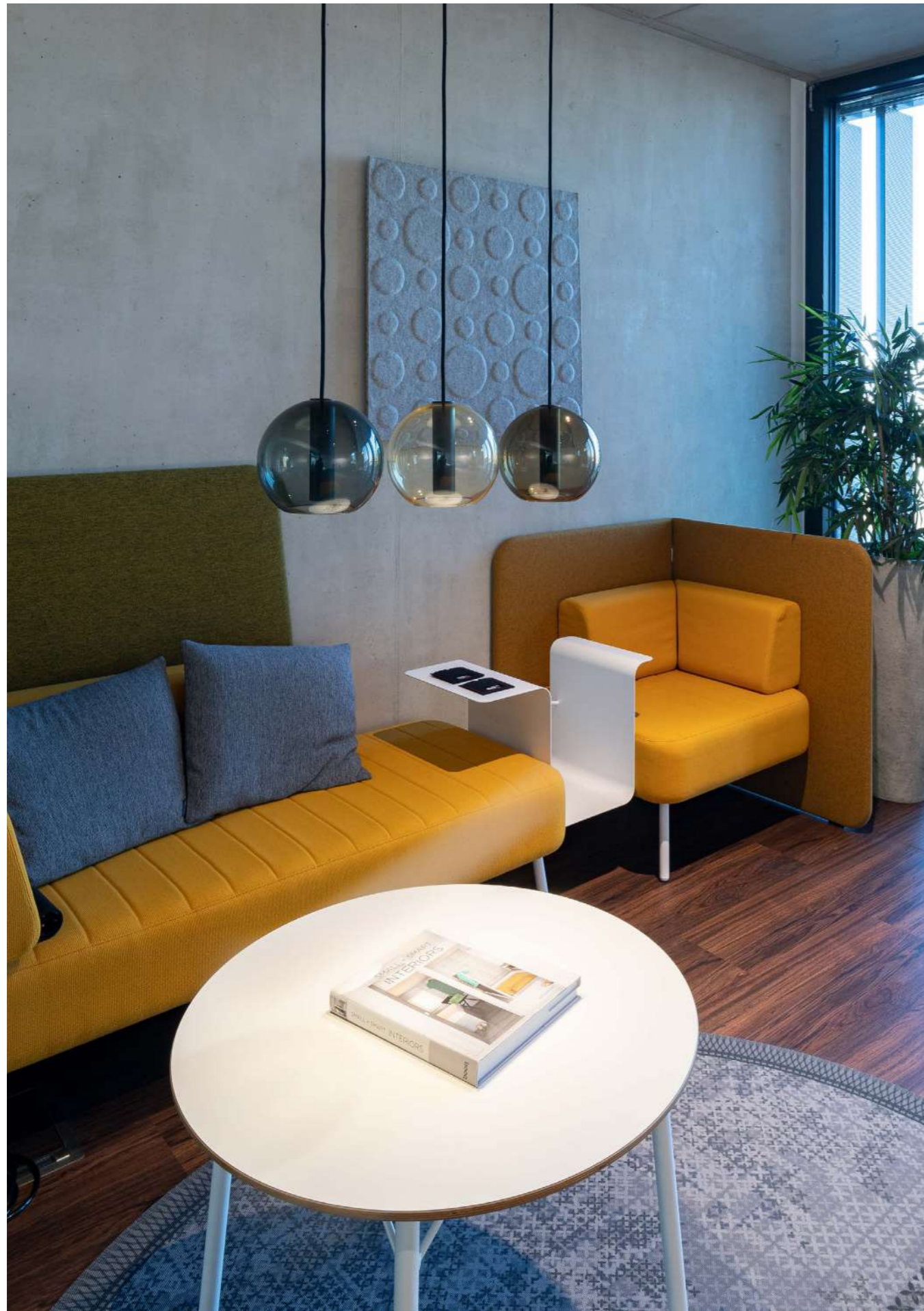

Wiesner & Hager Graz, Austria, Photo: Joachim Rauch

ROGGA CONFIGURATOR

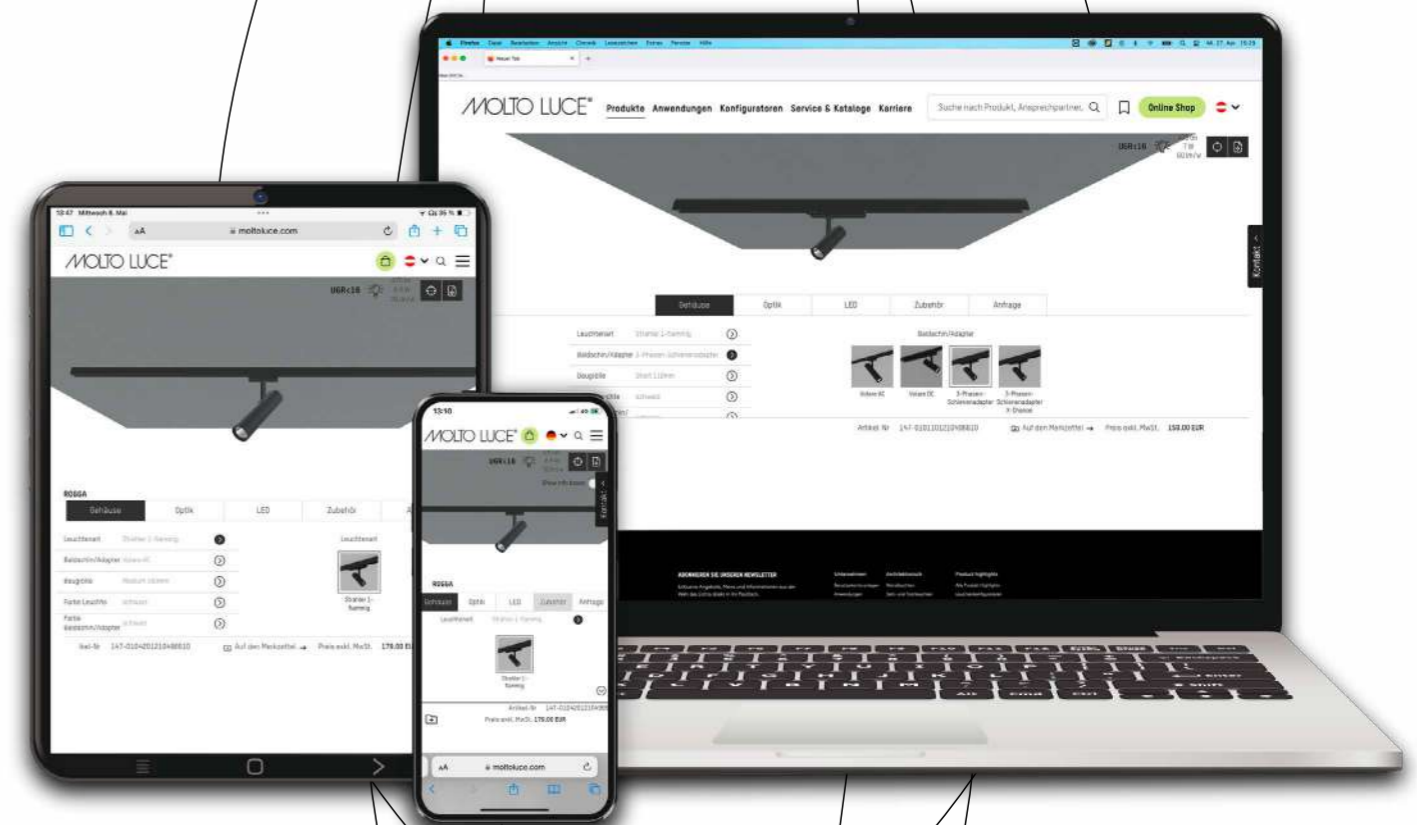
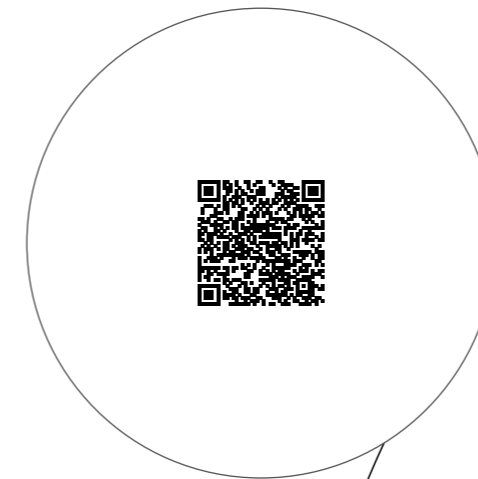



BLINDSPOT



Simens Recreation Area, Sofia, Bulgaria, Photo: Dian Stancer



Photo by W+K photography

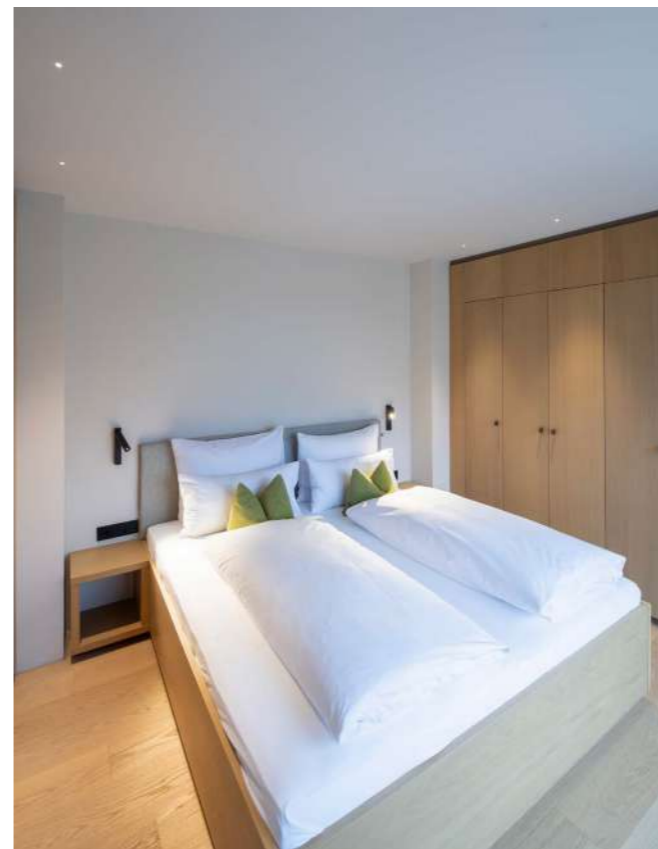

Hotel Bergeblick, Bad Tölz, Germany, Photo: Joachim Rauch

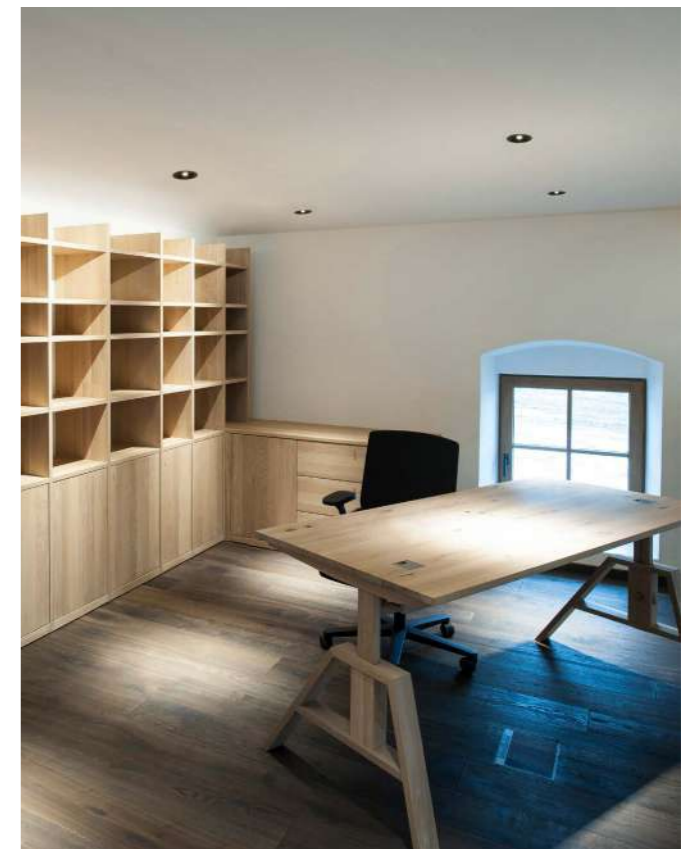

Private residence, Austria, Photo: Joachim Rauch



Photo by W+K photography

BLINDSPOT

TECHNOLOGY OUT OF THE SMALLEST SPACE

Beinahe unsichtbar bringt BLINDSPOT Beleuchtung in den Raum. Das Licht wird von der speziellen LFO Linse der Marke Bartenbach an der Lichtaustrittsöffnung auf 10mm reduziert und anschließend wieder auf 30° bzw. 55° aufgeweitet. LFO Linsen erzielen zudem beeindruckende Werte bei der Entblendung, was den Sehkomfort deutlich verbessert. Highlight ist die Version mit Mineralfaserplatte, bei der der Spot bis auf eine Lichtaustrittsöffnung von 13,5 mm gänzlich in der Decke verschwindet. Alles was bleibt, ist ein spannendes Lichtelebnis im Raum.

Blindspot brings light into a room almost invisible. The light is reduced to 10mm by the special LFO lens of the Bartenbach brand at the light emission opening and then widened again to 30° or 55°. The impressive glare control of the LFO lens significantly improves visual comfort. Particularly interesting is the version with mineral fiber plate, through which the spot disappears completely into the ceiling up to a light exit opening of 13.5 mm in diameter. All that remains is an exciting lighting experience in the room.

Design: Serge & Robert Cornelissen

VARIATIONS

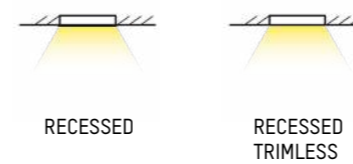

LED COLOURS

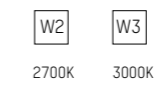

CORE COLOURS



CREATIVE COLOURS

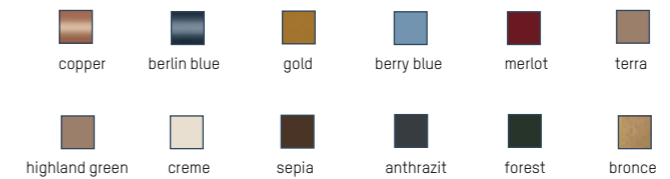

SPECIALS



MOUNTING



LFO Lens- Technology by Bartenbach

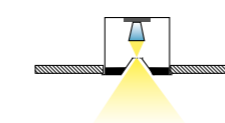



Hotel Vivo Ademaj, Schierling, Germany, Photo: Joachim Rauch

BLINDSPOT TURN R

BLINDSPOT TURN R

700mA UGR<16 Design: Serge & Robert Cornelissen

IP20

Einbauspot aus Aluminium · Oberfläche pulverbeschichtet · zurückversetzte Linse · Lichtaustrittsfläche von nur 10 mm
 Recessed LED spotlight in aluminium · surface powder coated · recessed lenses · light exit field with only 10 mm
 Incasso LED in alluminio · superficie verniciata a polveri · lenti spostati indietro · dispositivo d'illuminazione di soli 10 mm
 Encastré en aluminium · surface laquée en poudres · lentes déplacés au fond · plus que 10mm de surface d'émission de lumière

CODE	LED W	LUMEN
640-00101RRWWXX	9	400 - 430

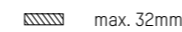
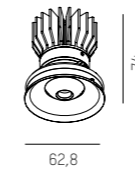

EINBAURAHMEN RECESSED FRAME

- 640-000035
- 640-000036



MONTAGERING MOUNTING RING

- 640-000010



WERKZEUG ZU MONTAGERING TOOL FOR MOUNTING RING

- 640-000020



DEMONTAGEWERKZEUG DISASSEMBLING TOOL

- 640-000040



Blindspot Turn R with recessed frame



Blindspot Turn R without recessed frame

LED CONVERTER	mA	DIM	FOR
30-880206	700	not dimmable	1 x BLINDSPOT R
24-151403	700	DALI dimmable	1 x BLINDSPOT R
700-3004	700	CASAMBI dimmable	1 x BLINDSPOT R



COMPLETE CODE		
RR = REFLECTOR	WW = LIGHT COLOUR	XX = COLOUR
30° medium = 01	LED 2700K = 23 CRI>90	white = 55
55° flood = 03	LED 3000K = 29 CRI>90	black = 66



Simens Recreation Area, Sofia, Bulgaria, Photo: Dian Stancer

BLINDSPOT R

BLINDSPOT R

700mA UGR<16 Design: Serge & Robert Cornelissen

IP20

LED Einbauspot aus Aluminium · Oberfläche: Mineralfaserplatte natur, überstreichbar · zurückversetzte Linse mit verschiedenen Abstrahlwinkeln
 Trimless recessed LED spotlight in aluminium · surface: mineral fiber board nature, paintable · recessed lense with different beam-angles
 Incasso LED a scomparsa in alluminio · superficie in fibra naturale tinteggiabile · lenti spostati indietro con varie emissioni
 Encastré LED sans cadre en aluminium · surface en peintable fibre naturelle · lentilles déplacés au fond avec d'émissions différentes

CODE	LED W	LUMEN
640-00201RRWW00	9	400 - 430

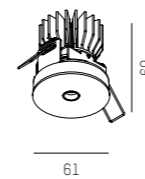

MONTAGERING
MOUNTING RING
640-000010



Blindspot R with mounting ring flush mounted

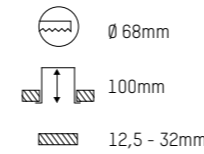

WERKZEUG ZU MONTAGERING
TOOL FOR MOUNTING RING
640-000020



DEMONTAGEWERKZEUG
DISASSEMBLING TOOL
640-000040



LED CONVERTER	mA	DIM	FOR
30-880206	700	not dimmable	1 x BLINDSPOT R
24-151403	700	DALI dimmable	1 x BLINDSPOT R
700-3004	700	CASAMBI dimmable	1 x BLINDSPOT R

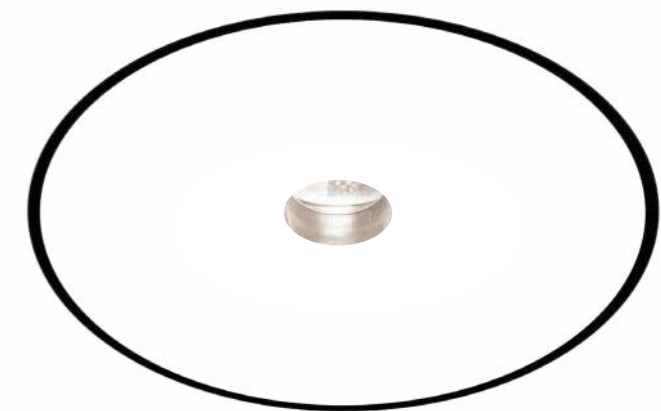

Blindspot R with mounting ring and shadow gap



COMPLETE CODE

RR = REFLECTOR

- 30° medium = **01**
- 55° flood = **03**

WW = LIGHT COLOUR

- LED 2700K = **23** CRI>90
- LED 3000K = **29** CRI>90





Burg Vital Resort, Lech, Austria, Photo: Joachim Rauch

RIDE SPOT R

RIDE SPOT R

220-240V AC

Design: INHOUSE

IP20

Schwenkbarer LED Einbauspot aus Aluminium · Oberfläche pulverbeschichtet oder eloxiert · facettierte Linse · Ausführung ein- oder zweiflammig
 Tilting recessed spotlight in aluminium t · surface powder coated or anodised · faceted lenses · single or double headed
 Incasso LED orientabile in alluminio · superficie verniciata a polveri o anodizzata · lente sfaccettata · mono o doppia testa
 Encastré orientable à LED en aluminium · surface laquée en poudre ou anodisée · lentille à facettes · mono ou double spot

RIDE SPOT 1 R

CODE	SYS W	LUMEN
577-00601RRWWXXO	4	140 - 160

inkl. Konverter / nicht dimmbar
 incl. converter / not dimmable

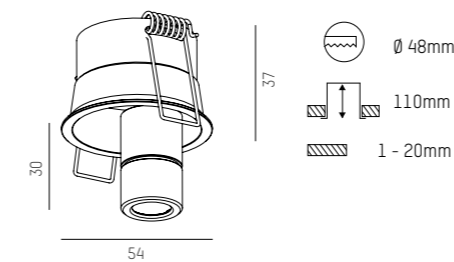

RIDE SPOT 2 R

CODE	SYS W	LUMEN
577-00602RRWWXXY	7	290 - 320

inkl. Konverter / incl. converter

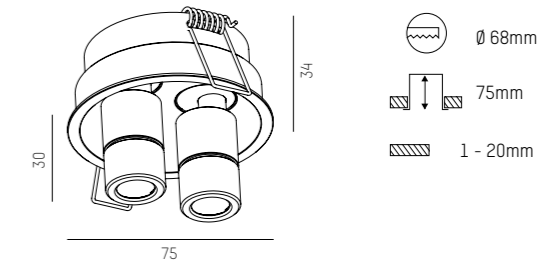

COMPLETE CODE			
RR = BEAM ANGLE	WW = LIGHT COLOUR	XX = COLOUR	Y = DIMMABLE
<ul style="list-style-type: none"> spot 12° = 01 medium 21° = 02 	<ul style="list-style-type: none"> LED 2700K = 23 CRI>90 LED 3000K = 29 CRI>90 LED 4000K = 24 CRI>90 	<ul style="list-style-type: none"> white = 05 black = 06 alu anodized = 08 	<ul style="list-style-type: none"> switchable = 0 analog dimm 1-10V = a DALI dimm = d



Sporthotel Gut Brandlhof, Saalfelden, Austria, Photo: Joachim Rauch

GRID TRIMLESS R

GRID TRIMLESS R

700mA

UGR<19

Design: INHOUSE

IP20

Rahmenloser LED Einbauspot · Oberfläche pulverbeschichtet · zurückversetzte Linsen · perfekte Entblendung durch Hochglanzraster
 Trimless recessed LED spotlight · surface powder-coated · recessed lenses with different beam-angles · perfect anti-glare due to high-gloss grid
 Incasso LED a scomparsa · superficie verniciata a polveri · lenti spostati indietro con varie emissioni · controllo anti-abbagliato per griglia lucida
 Encastré LED sans cadre · surface laquée en poudre · lentilles décalées au fond avec d'émissions différentes · control anti-éblouie pour grille brillé

GRID R EINBAUBOX RAHMENLOS GRID R RECESSING BOX TRIMLESS

BOX	COLOUR
629-205	white

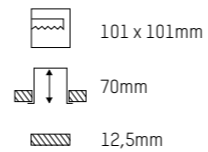
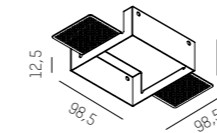

GRID R LICHTEINSATZ GRID R LIGHT INSERT

CODE	LED W	LUMEN
629-0301RWWX	10	920 - 1220
629-0302RWWX	16,5	1370 - 1800

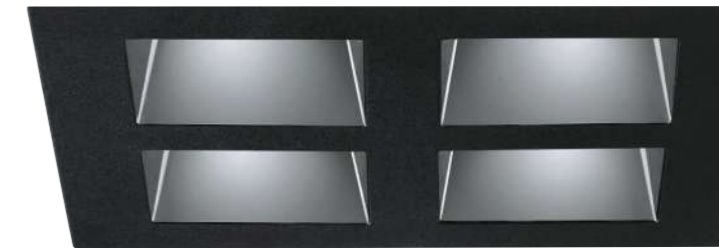
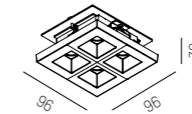

LED CONVERTER	mA	DIM	FOR
30-880206	700	not dimmable	1 x GRID TRIMLESS R
24-151403	700	DALI dimmable	1 x GRID TRIMLESS R
700-3004	700	CASAMBI dimmable	1 x GRID TRIMLESS R



COMPLETE CODE		
R = REFLECTOR	WW = LIGHT COLOUR	X = COLOUR
15° spot = 1	LED 2700K = 46 PREMIUM CRI>90	white = 5
30° medium = 2	LED 3000K = 49 PREMIUM CRI>90	black = 6
45° + 15° asymm = 3	LED 3500K = 47 PREMIUM CRI>90	
	LED 4000K = 24 CRI>90	



Private residence, Norway, Photo: AKB Lighting as

GRID R

GRID R

700mA

UGR<19

Design: INHOUSE

IP20

LED Einbauspot · Oberfläche pulverbeschichtet · zurückversetzte Linsen · perfekte Entblendung durch Hochglanzraster
 Recessed LED spotlight · surface powder-coated · recessed lenses with different beam-angles · perfect anti-glare due to high-gloss grid
 Incasso LED · superficie verniciata a polveri · lenti spostati indietro con varie emissioni · controllo anti-abbagliato per griglia lucida
 Encastré LED · surface laquée en poudre · lentes déplacés au fond avec d'émissions différentes · control anti-ébloui pour grille brillé

GRID R EINBAUBOX GRID R RECESSING BOX

BOX

629-10X

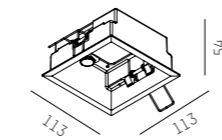

106 x 106mm

90mm

8 - 30mm

GRID R LICHTEINSATZ GRID R LIGHT INSERT

CODE

629-0301RWWX

LED W

10

LUMEN

920 - 1220

629-0302RWWX

16,5

1370 - 1800

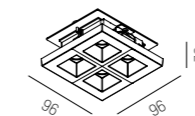

Lichteinsatz höhenverstellbar mittels Verstellerschrauben
 Light insert height-adjustable with adjusting screw

UNIVERSAL BETONEINBAUGEHÄUSE UNIVERSAL CONCRETE HOUSING

GEHÄUSE / HOUSING

332-1001

MATERIAL

zinc-plated

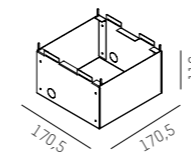

ABDECKUNG QUADRATISCH inkl. Zentrierteil COVER SQUARE inkl. centering

FÜR GEHÄUSE / FOR HOUSING

332-1502

MATERIAL

zinc-plated

nicht geeignet für Sichtbeton
 not adapted for exposed concrete

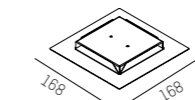

106 x 106mm

LED CONVERTER	mA	DIM	FOR
30-880206	700	not dimmable	1 x GRID R
24-151403	700	DALI dimmable	1 x GRID R
700-3004	700	CASAMBI dimmable	1 x GRID R



COMPLETE CODE		
R = REFLECTOR	WW = LIGHT COLOUR	X = COLOUR
15° spot = 1	LED 2700K = 46 PREMIUM CRI>90	white = 5
30° medium = 2	LED 3000K = 49 PREMIUM CRI>90	black = 6
45° + 15° asymm = 3	LED 3500K = 47 PREMIUM CRI>90	
	LED 4000K = 29 CRI>90	



Brautschatz, Götzis, Austria, Photo: Joachim Rauch

GRID TURN R

GRID TURN R

220-240V AC

UGR<19

Design: INHOUSE

IP20

LED Halbeinbaustrahler aus Aluminium · Oberfläche pulverbeschichtet · zurückversetzte Linsen · perfekte Entblendung durch Hochglanzraster
 Semi-recessed LED spotlight in aluminium · surface powder-coated · recessed lenses · perfect anti-glare due to high-gloss grid
 Semi-incasso a LED in alluminio · superficie verniciata a polveri · lenti spostati indietro · controllo anti-abbagliato per griglia lucida
 Semi-encastré à LED en aluminium · surface laquée en poudre · lentilles déplacés au fond · contrôle anti-éblouie pour grille brillé

CODE	SYS W	LUMEN
629-0401RWWXXY	8,5	920 - 1220
629-0402RWWXXY	14,5	1370 - 1800

inkl. Konverter / incl. converter

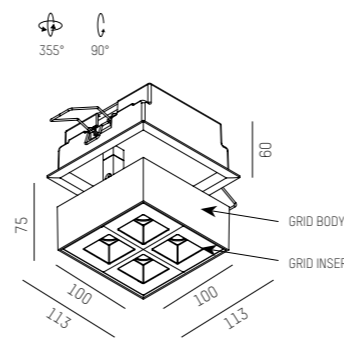

- 106 x 106mm
- 90mm
- 8 - 30mm



COMPLETE CODE				
R = REFLECTOR	WW = LIGHT COLOUR	X = COLOUR BODY	X = COLOUR INSERT	Y = DIMMABLE
15° spot = 1	LED 2700K = 46 PREMIUM CRI>90	white = 5	white = 5	switchable = 0
30° medium = 2	LED 3000K = 49 PREMIUM CRI>90	black = 6	black = 6	DALI dim = ddd
45° + 15° asymm = 3	LED 3500K = 47 PREMIUM CRI>90			
	LED 4000K = 29 CRI>90			



Private residence, Norway, Photo: AKB Lighting as

GRID SD

GRID SD / GRID TURN SD

220-240V AC UGR<19 Design: INHOUSE

IP20

LED Aufbaustrahler aus Aluminium · Oberfläche pulverbeschichtet · zurückversetzte Linsen · perfekte Entblendung durch Hochglanzraster
 LED spotlight in aluminium · surface powder-coated · recessed lenses · perfect anti-glare due to high-gloss grid
 Faretto a LED in alluminio · superficie verniciata a polveri · lenti spostati indietro · controllo anti-abbagliato per griglia lucida
 Spot à LED en aluminium · surface laquée en poudre · lentilles décalées au fond · control anti-ébloui pour grille brillé

GRID SD

CODE	SYS W	LUMEN
629-0501RWWXXY	8,5	920 - 1220
629-0502RWWXXY	14,5	1370 - 1800

inkl. Konverter / incl. converter

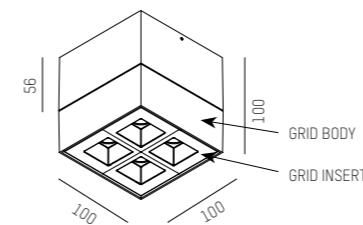

GRID TURN SD

CODE	SYS W	LUMEN
629-0601RWWXXY	8,5	920 - 1220
629-0602RWWXXY	14,5	1370 - 1800

inkl. Konverter / incl. converter

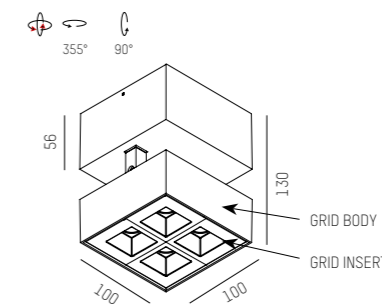

COMPLETE CODE				
R = REFLECTOR	WW = LIGHT COLOUR	X = COLOUR BODY	X = COLOUR INSERT	Y = DIMMABLE
15° spot = 1	LED 2700K = 46 PREMIUM CRI>90	white = 5	white = 5	switchable = 0
30° medium = 2	LED 3000K = 49 PREMIUM CRI>90	black = 6	black = 6	DALI dim = ddd
45° + 15° asymm = 3	LED 3500K = 47 PREMIUM CRI>90			
	LED 4000K = 29 CRI>90			



VIBO R

VIBO R

500mA

UGR<16

Design: INHOUSE

IP20  

Einbaustrahler aus Aluminium · Oberfläche pulverbeschichtet · spezielle Linsenoptik ohne Streulicht · Dekoring pulverbeschichtet
 Recessed spotlight in aluminium · surface powder-coated · special lens optics without scattered light · decoration ring powder-coated
 Incasso in alluminio · superficie verniciata a polveri · ottica speciale senza luce diffusa · anello decorativo verniciato a polvere
 Encastré en aluminium · surface laquée en poudre · lentille optique sans lumière parasite · anneau décoratif laquée en poudre





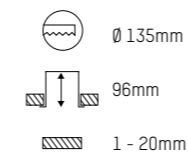
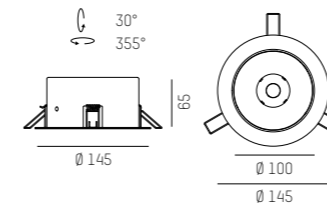



CODE	LED W	LUMEN
668-00301RRWWXX	6	340 - 470

DEKORRING für 2 farbige Versionen DECOR RING for bi-coloured versions	FARBE COLOUR
668-000105	white
668-000106	black



LED CONVERTER	mA	DIM	FOR
24-141131	500	not dimmable	1 x VIBO R
24-151403	500	DALI dimmable	1 x VIBO R
700-3004	500	CASAMBI dimmable	1 x VIBO R



COMPLETE CODE		
RR = REFLECTOR	WW = LIGHT COLOUR	XX = COLOUR
 10° spot = 02	 LED 2700K = 23 CRI>90	 white = 55
 23° medium = 05	 LED 3000K = 29 CRI>90	 black = 66
 35° flood = 08	 LED 4000K = 24 CRI>90	



VIBO SD

VIBO SD

220-240V AC

UGR<16

Design: INHOUSE

IP20

LED Aufbaustrahler aus Aluminium · Oberfläche pulverbeschichtet · zurückversetzte Linsen · perfekte Entblendung durch Hochglanzraster
 LED spotlight in aluminium · surface powder-coated · recessed lenses · perfect anti-glare due to high-gloss grid
 Faretto a LED in alluminio · superficie verniciata a polveri · lenti spostati indietro · controllo anti-abbagliato per griglia lucida
 Spot à LED en aluminium · surface laquée en poudre · lentilles déplacées au fond · contrôle anti-éblouie pour grille brillée

VIBO SD

CODE	SYS W	LUMEN
668-00101RRWWXX0	8	340 - 470

nicht dimmbar / not dimmable

VIBO SD DIMM

CODE	SYS W	LUMEN
668-00201RRWWXXd	8	340 - 470

DALI dimmbar / DALI dimmable

DEKORRING für 2 farbige Versionen DECOR RING for bi-coloured versions	FARBE COLOUR
668-000105	white
668-000106	black



COMPLETE CODE		
RR = REFLECTOR	WW = LIGHT COLOUR	XX = COLOUR
10° spot = 02	LED 2700K = 23 CRI>90	white = 55
23° medium = 05	LED 3000K = 29 CRI>90	black = 66
35° flood = 08	LED 4000K = 24 CRI>90	



VALO



Hotel Vivo Ademaj Schierling, Germany, Photo: Joachim Rauch

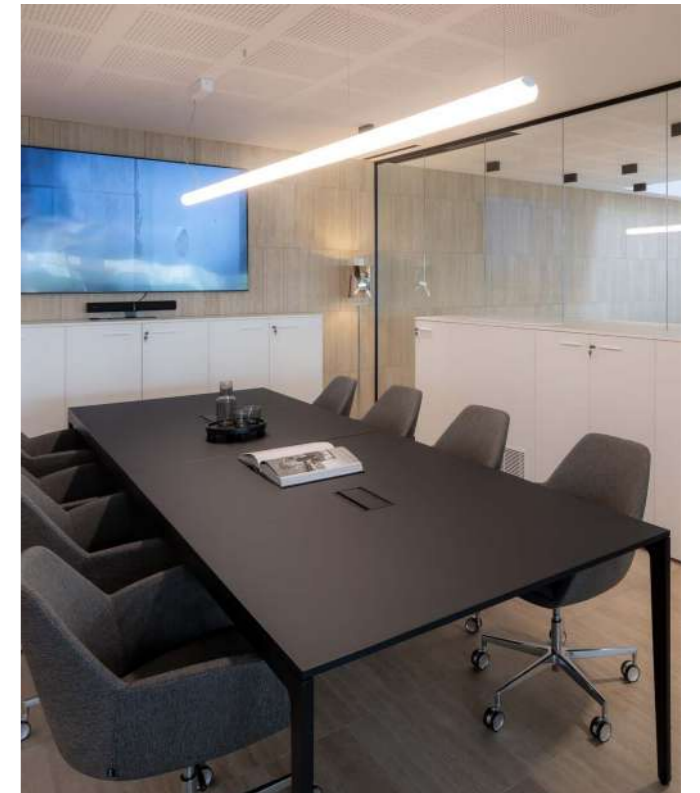

Ristrutturazione nuova sede Tyrolit, Bassano del Grappa, Italy
Photo: Marco Zanta



Intersport Tscherne, Salzburg, Austria, Photo: Joachim Rauch

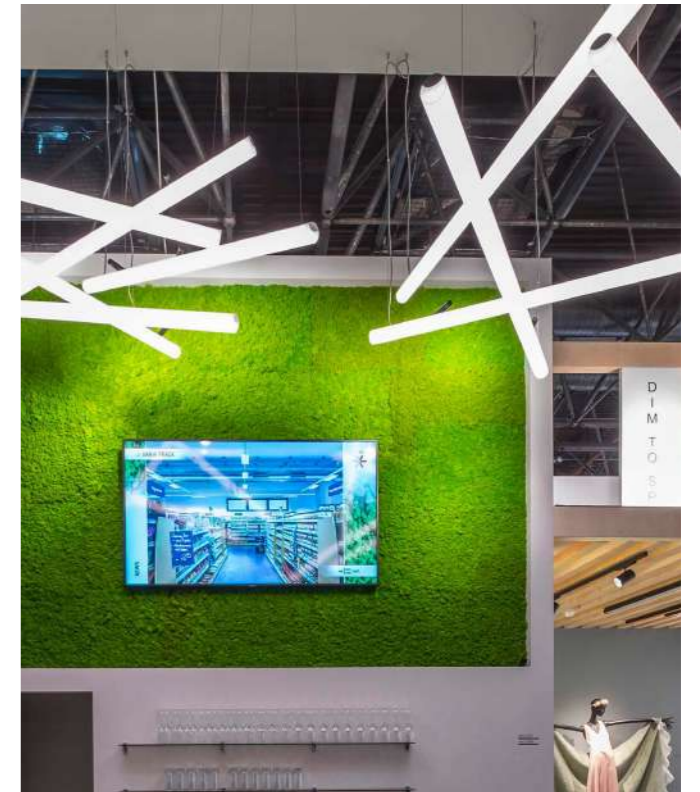

Euroshop Fair, Düsseldorf, Germany, Photo: Molto Luce



Mode Rudolfo, Wels, Austria
Photo: Joachiim Rauch

MORE THAN A TUBE

Unser schlichtes und zurückhaltendes 48V Lichtrohrsystem mit einem Durchmesser von nur 7cm schafft eine optimale Verbindung aus Grundlicht und Akzentuierung. Eine nicht sichtbar im opalen Kunststoffrohr eingelassene 48V Stromschiene bietet die Möglichkeit, die homogene Grundbeleuchtung der VALO optional mit Spots zu erweitern. Mit den 1-flammig sowie 2-flammig erhältlichen Strahlern lassen sich gekonnt Highlights im Raum in Szene setzen. Für ein hohes Maß an Flexibilität in der Lichtgestaltung sind die Strahlereinsätze frei in der Schiene platzierbar und lassen sich sowohl horizontal als auch vertikal schwenken.

Our simple and modest 48V light tube system with a diameter of only 7 cm perfectly combines basic lighting and accentuation. With the 48V track embedded invisibly in the opal plastic tube, it is possible to expand VALO's homogenous basic lighting optionally with spots. The spotlights, available in a one-lamp or two-lamp version, create individual accents in interior spaces. The fact that the spotlight inserts can be individually placed in the rail offers a high degree of flexibility for lighting design. On top of that, they can be swivelled horizontally as well as vertically.

Design: INHOUSE

VARIATIONS

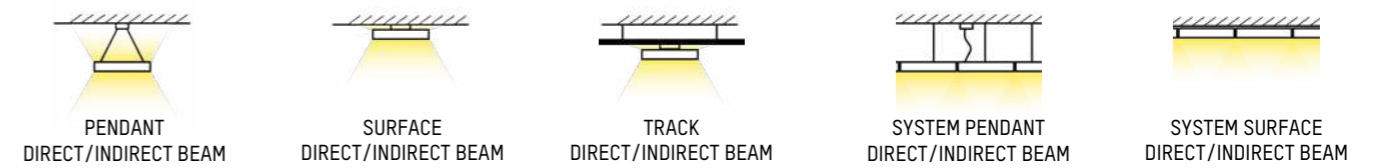

FORM

linear

LED COLOURS

W2 2700K W3 3000K W4 4000K

CORE COLOURS



SYSTEM INSERTS

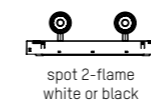
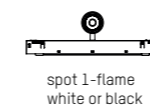

LIGHT BEAM

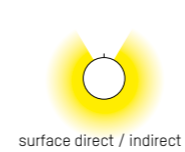
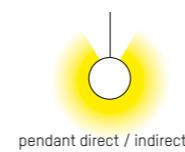

VALO



Work Experience Space , Cologne, Germany, Photo: Project Rheinland AG

VALO HV PDI

IP20

VALO HV PDI
220-240V AC 50/60Hz Design: INHOUSE

Zylindrische Pendelleuchte · sehr homogene Ausleuchtung · 230V Spannungsversorgung, ohne rückseitige 48V Stromschiene
Pendant in cylindric shape · homogeneous lighting · 230V power supply, without rear 48V power rail
Lampada a sospensione con struttura cilindrica · alimentazione 230V, senza barra di alimentazione 48V posteriore
Lampe à suspension avec couvercle cylindrique · alimentation 230V, sans rail d'alimentation arrière 48V

CODE	SYS W	L mm	LUMEN
720-0073210 WWXXY	26	1146	2920 - 3000

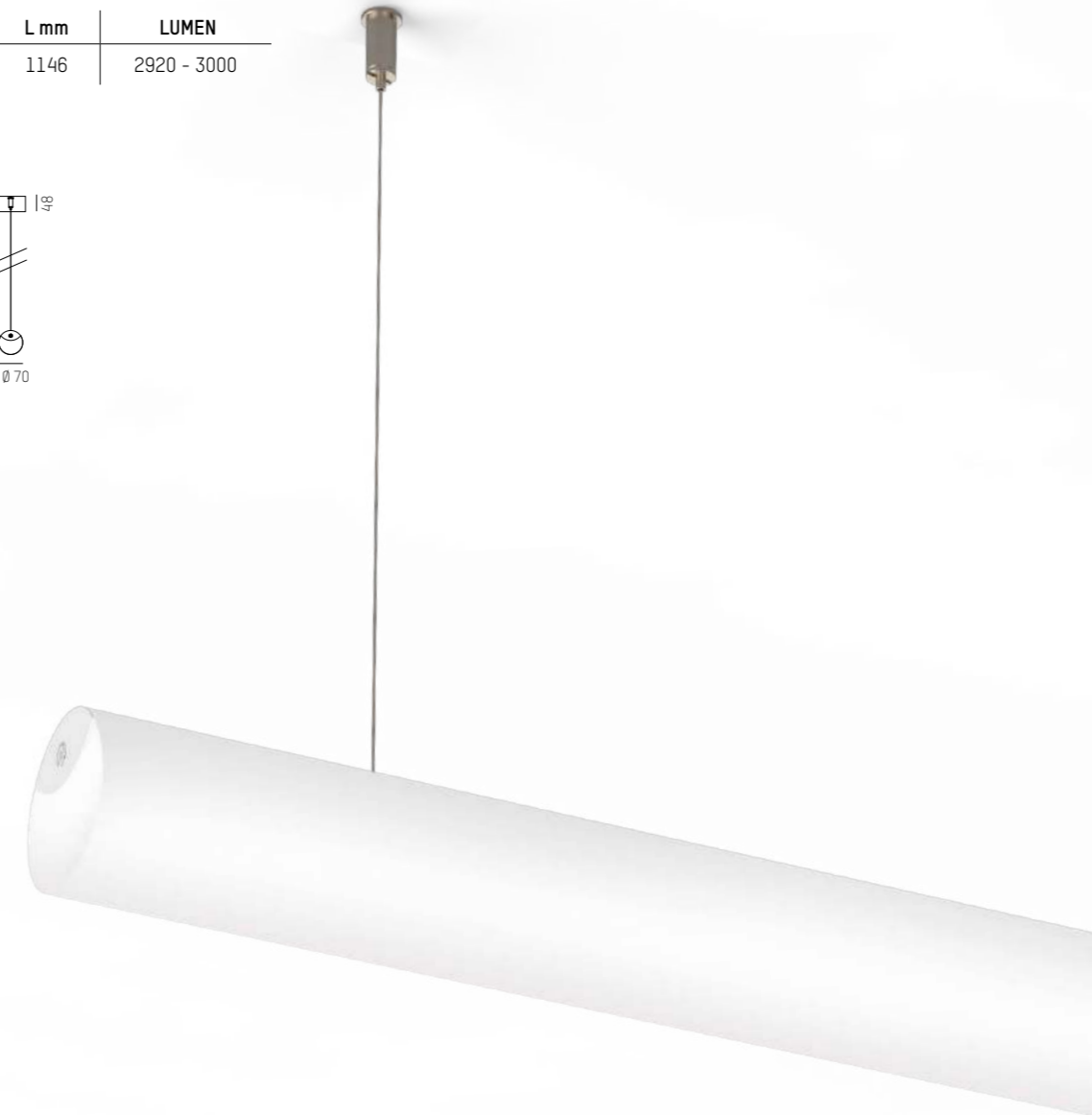
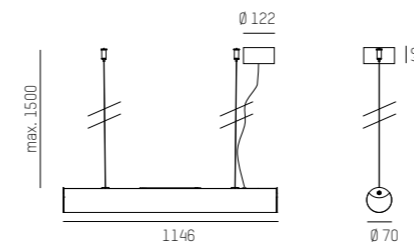

COMPLETE CODE														
WW = LIGHT COLOUR	XX = COLOUR	Y = DIMMABLE												
<table border="1"> <tr> <td>W2</td> <td>LED 2700K = 23 CRI>90</td> </tr> <tr> <td>W3</td> <td>LED 3000K = 29 CRI>90</td> </tr> <tr> <td>W4</td> <td>LED 4000K = 24 CRI>90</td> </tr> </table>	W2	LED 2700K = 23 CRI>90	W3	LED 3000K = 29 CRI>90	W4	LED 4000K = 24 CRI>90	<table border="1"> <tr> <td>W</td> <td>white = 55</td> </tr> </table>	W	white = 55	<table border="1"> <tr> <td>Ⓢ</td> <td>switchable = 0</td> </tr> <tr> <td>Ⓣ</td> <td>DALI dim = d</td> </tr> </table>	Ⓢ	switchable = 0	Ⓣ	DALI dim = d
W2	LED 2700K = 23 CRI>90													
W3	LED 3000K = 29 CRI>90													
W4	LED 4000K = 24 CRI>90													
W	white = 55													
Ⓢ	switchable = 0													
Ⓣ	DALI dim = d													



Bioclean, Hasselager, Denmark, Photo: onthespot

VALO PDI

VALO PDI

220-240V AC

50/60Hz

Design: INHOUSE

IP20

Zylindrische Hängeleuchte · homogene Ausleuchtung · deckenseitige 48V Stromschiene · 48V Konverter im Baldachin · Spot Einsätze nachrüstbar
 Pendant in cylindric shape · homogeneous lighting · 48V Track on the top side · 48V Driver included in canopy · spot insert can be edited
 Lampada a sospensione con struttura cilindrica · binario superiore da 48V · convertitore 48V nel rosone · spot intercambiabili anche dopo l'installazione
 Lampe à suspension avec couvercle cylindrique · rail de plafond 48V · convertisseur 48V dans la verrière · les inserts spot pouvant être réaménagés

CODE	SYS W	L mm	LUMEN
720-0023110WWXXY	15	586	1170 - 1290
720-0023210WWXXY	30	1146	2340 - 2580
720-0023310WWXXY	45	1706	3510 - 3870
720-0023410WWXXY	60	2266	4680 - 5170
720-0023510WWXXY	90	3386	7020 - 7750

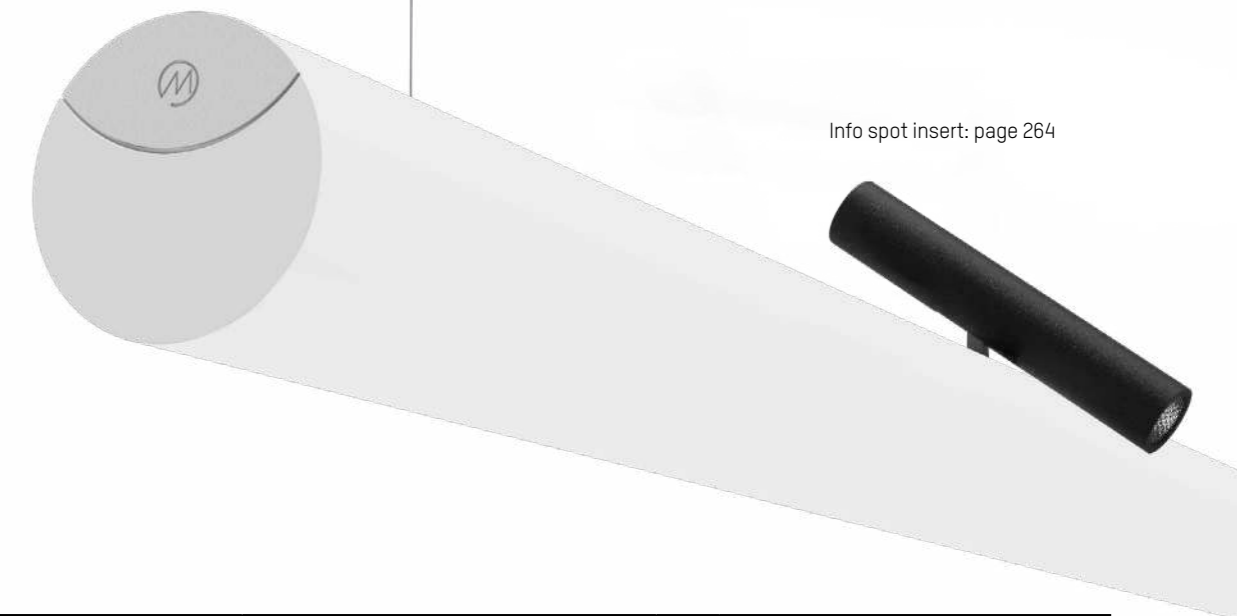
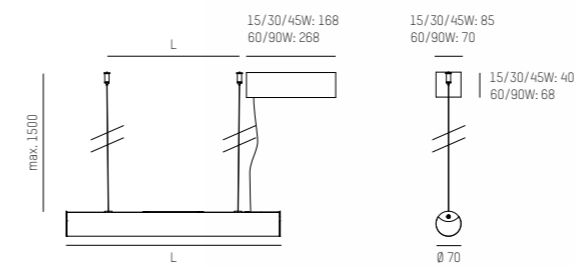

Info spot insert: page 264



COMPLETE CODE

WW = LIGHT COLOUR	XX = COLOUR	Y = DIMMABLE
W2 LED 2700K = 23 CRI>90	W white = 55	S switchable = 0
W3 LED 3000K = 29 CRI>90		D DALI dim = d
W4 LED 4000K = 24 CRI>90		B BLUETOOTH dim = b



VALO SDI

VALO SDI

220-240V AC

50/60Hz

Design: INHOUSE

IP20

Zylindrische Wand- Deckenleuchte · sehr homogene Ausleuchtung · 48V Konverter im Baldachin
 Wall- Surface luminaries in cylindric shape · homogeneous lighting · 48V Driver included in canopy
 Lampada da parete / soffitto con struttura cilindrica · convertitore 48V nel rosone intercambiabili anche dopo l'installazione
 Lampe de plafond / murale avec couvercle cylindrique · rconvertisseur 48V dans la verrière pouvant être réaménagés

CODE	SYS W	L mm	LUMEN
720-0033110WWXXY	15	586	1170 - 1290
720-0033210WWXXY	30	1146	2340 - 2580
720-0033310WWXXY	45	1706	3510 - 3870
720-0033410WWXXY	60	2266	4680 - 5170
720-0033510WWXXY	90	3386	7020 - 7750

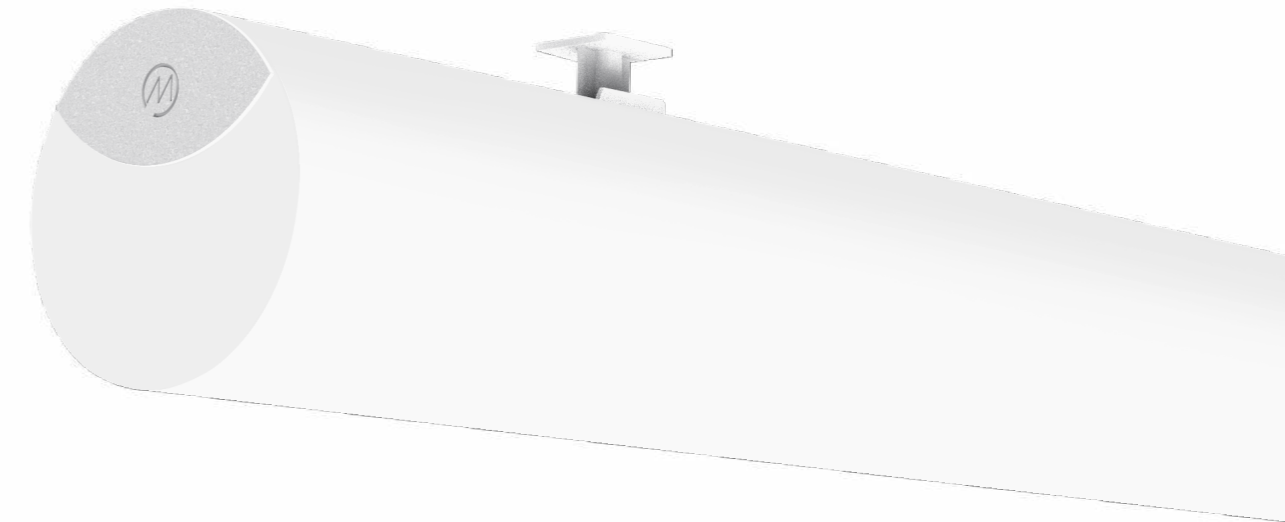
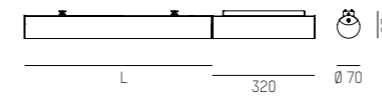

COMPLETE CODE

WW = LIGHT COLOUR	XX = COLOUR	Y = DIMMABLE
W2 LED 2700K = 23 CRI>90	W white = 55	Ⓢ switchable = 0
W3 LED 3000K = 29 CRI>90		Ⓣ DALI dim = d
W4 LED 4000K = 24 CRI>90		Ⓟ BLUETOOTH dim = b



Molto Luce, Weißkirchen, Austria, Photo: Joachim Rauch

VALO TRACK

VALO TRACK

220-240V AC 50/60Hz Design: INHOUSE

IP20

Zylindrische Stromschienenleuchte · sehr homogene Ausleuchtung · 230V Spannungsversorgung, ohne rückseitige 48V Stromschiene
 Pendant in cylindric shape · homogeneous lighting · 230V power supply, without rear 48V power rail
 Lampada a sospensione con struttura cilindrica · alimentazione 230V, senza barra di alimentazione 48V posteriore
 Lampe à suspension avec couvercle cylindrique · alimentation 230V, sans rail d'alimentation arrière 48V

CODE	SYS W	L mm	LUMEN
720-0083210WWXXY	26	1146	2920 - 3000

355°

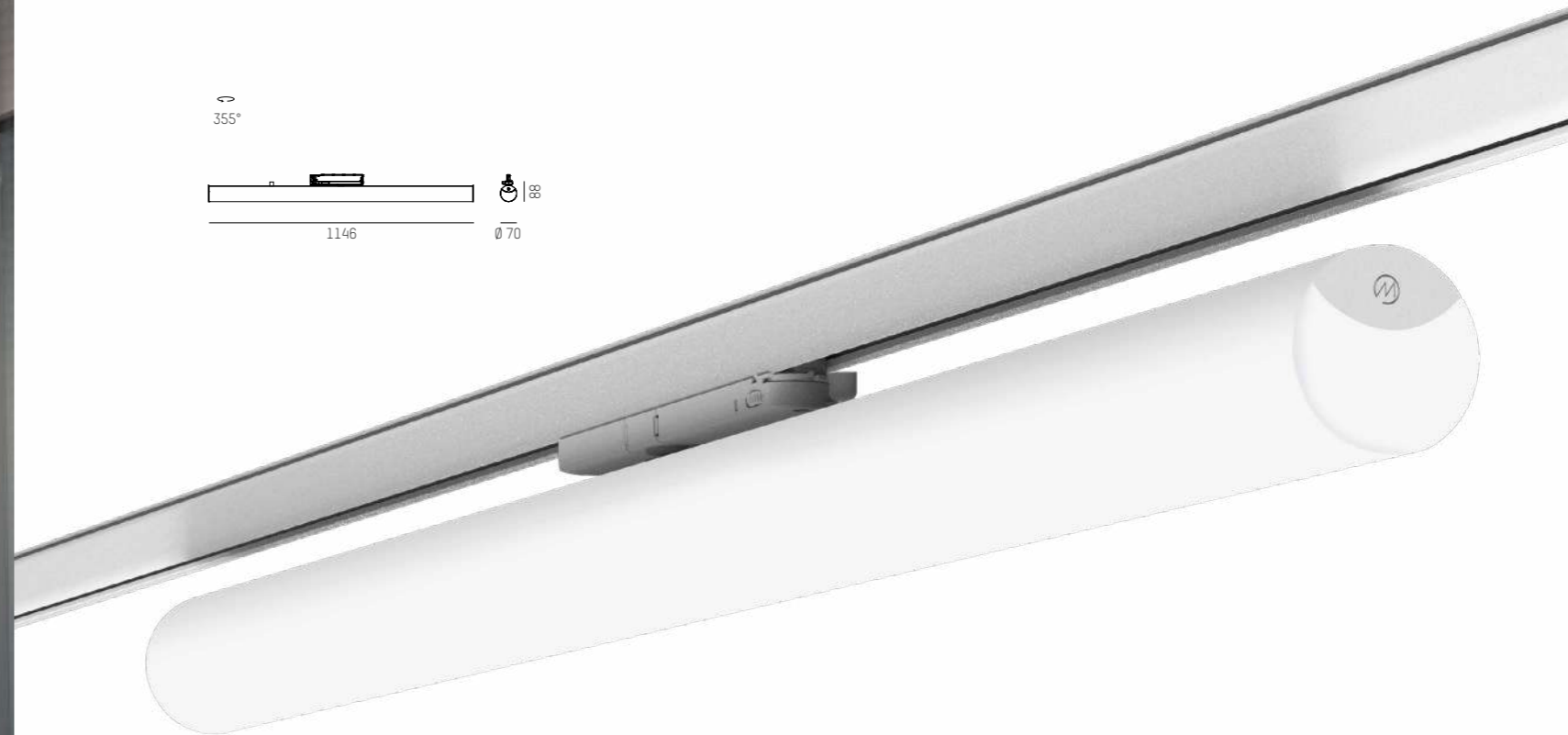
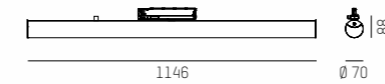

COMPLETE CODE

WW = LIGHT COLOUR	XX = COLOUR	Y = DIMMABLE
W2 LED 2700K = 23 CRI>90	W white = 55	S switchable = 0
W3 LED 3000K = 29 CRI>90		P PULSE DALI dim = p
W4 LED 4000K = 24 CRI>90		B BLUETOOTH dim = b

VALO SYSTEM

VALO SYSTEM TUBE

48V DC 50/60Hz

IP20

Zylindrische Systemleuchte · deckenseitige 48V Stromschiene · Spot Einsätze an jeder Stelle einsetzbar (bei abgehängten Lichtsystemen)
 System luminaires in cylindrical shape · 48V Track on the top side · spot insert can be edited (for suspended lighting systems)
 Lampada da sistema cilindrica · binario superiore da 48V · inserti spot inseribili in qualsiasi punto (per sistemi di illuminazione a sospensione)
 Lampe système cylindrique · voie de plafond 48V · les inserts spot peuvent être utilisés partout (pour les systèmes d'éclairage suspendus)

CODE	SYS W	L mm	LUMEN
720-0013110WWXXY	12	586	1170 - 1290
720-0013210WWXXY	24	1146	2340 - 2580
720-0013310WWXXY	36	1706	3510 - 3870
720-0013410WWXXY	48	2266	4680 - 5170
720-0013510WWXXY	72	3386	7020 - 7750



ENDDECKELSET - 2 Stk.
 END PIECE SET - 2 pcs.
 720-001180000050
 FARBE COLOUR
 white

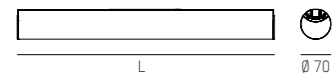

COMPLETE CODE		
WW = LIGHT COLOUR	XX = COLOUR	Y = DIMMABLE
LED 2700K = 23 CRI>90	white = 55	switchable = 0
LED 3000K = 29 CRI>90		DALI dim = d
LED 4000K = 24 CRI>90		BLUETOOTH dim = b

VALO SYSTEM SPOT

48V DC 50/60Hz

IP20

System Spot Einsatz · 1- und 2- flammige Version · schaltbar, DALI oder Smart Bluetooth dimmbar · Oberfläche pulverbeschichtet
 System Spot insert · 1- and 2- spot version · switchable, DALI or Smart Bluetooth dimmable · surface powder-coated
 Proiettore da sistema · versione ad 1 o 2 spot · on/off, DALI o dimmerabile Smart Bluetooth · superficie verniciata a polveri
 Encart pour spot sur le système · version spot 1 ou 2 · on/off, DALI- ou Smart Bluetooth dimmable · surface lacquée en poudre

VALO SYSTEM SPOT 1-FLAME

CODE	SYS W	L mm	LUMEN
720-004410RWWXXY	7	170	600 - 730

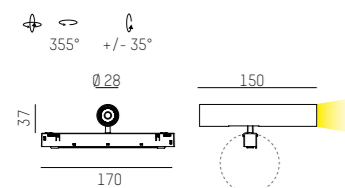

VALO SYSTEM SPOT 2-FLAME

CODE	SYS W	L mm	LUMEN
720-004420RWWXXY	14	170	2x 600 - 2x 730

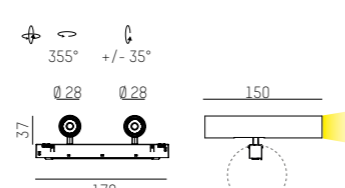

COMPLETE CODE			
R = REFLECTOR	WW = LIGHT COLOUR	XX = COLOUR	Y = DIMMABLE / DIMMABLE
24° spot = 1	LED 2700K = 43 PREMIUM CRI>90	white = 55	switchable = 0
38° flood = 3	LED 3000K = 49 PREMIUM CRI>90	black = 66	DALI dim = d (only single spot)
	LED 4000K = 24 CRI>90		BLUETOOTH dim = b (only single spot)

PRODUCTS

COMPONENTS

ENDEINSPEISUNG PDI END POWER FEED PDI	FARBE COLOUR
720-001230000050	white

Für Pendelsysteme
 inkl. 48V Konverter max. 150W
 for system pendant mounting
 incl. 48V driver max. 150W

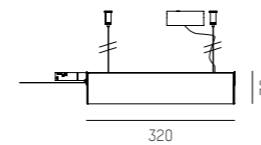

MITTELSPEISUNG PDI CENTER POWER FEED PDI	FARBE COLOUR
720-001240000050	white

Für Pendelsysteme
 inkl. 48V Konverter max. 150W
 for system pendant mounting
 incl. 48V driver max. 150W

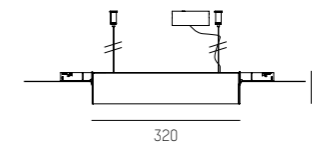

ABHÄNGUNG SUSPENSION	LÄNGE LENGTH
720-001050000000	max. 1500mm
720-001060000000	max. 4000mm

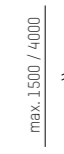

ENDEINSPEISUNG SDI END POWER FEED SDI	FARBE COLOUR
720-001080000050	white

Für Wand-/ Deckensysteme
 inkl. 48V Konverter max. 150W
 for system wall ceiling mounting
 incl. 48V driver max. 150W

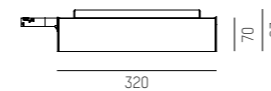

MITTELSPEISUNG SDI CENTER POWER FEED SDI	FARBE COLOUR
720-001090000050	white

Für Wand-/ Deckensysteme
 inkl. 48V Konverter max. 150W
 for system wall ceiling mounting
 incl. 48V driver max. 150W

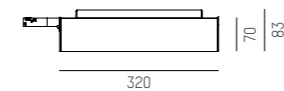

INDIREKTABDECKUNG WEISS INDIRECT COVER WHITE	LÄNGE LENGTH
720-001110000000	586mm
720-001120000000	1146mm
720-001130000000	1706mm
720-001140000000	2266mm
720-001150000000	3386mm
720-001220000000	per meter



BALDACHIN AUFBAU CANOPY SURFACE	FARBE COLOUR	LEISTUNG POWER
720-001210000550	white	max. 70W
720-001210000660	black	max. 70W
720-001160000550	white	max. 150W
720-001160000660	black	max. 150W

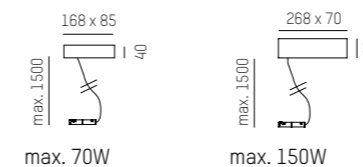

BALDACHIN EINBAU CANOPY RECESSED	FARBE COLOUR	LEISTUNG POWER
720-001170000550	white	max. 150W
720-001170000660	black	max. 150W

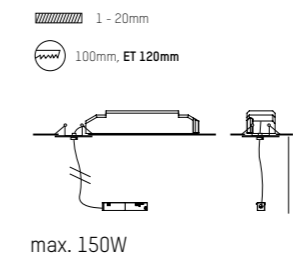

DEMONTAGEWERKZEUG DEMOUNTING TOOL

720-001010000000
 für Wand-/ Deckenleuchten
 for wall- ceiling luminaires

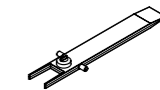

LINEARVERBINDER LINEAR JUNCTION	FARBE COLOUR
720-001020000050	white

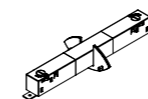

FLEXVERBINDER FLEXIBLE JUNCTION	FARBE COLOUR
720-001040000050	white



WANDMONTAGESSET WALL MOUNTING SET	FARBE COLOUR
720-001250000000	white

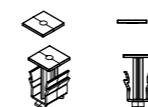

DECKENMONTAGESSET CEILING MOUNTING SET	FARBE COLOUR
720-001070000000	white



PRODUCTS

BACK TO CONTENT

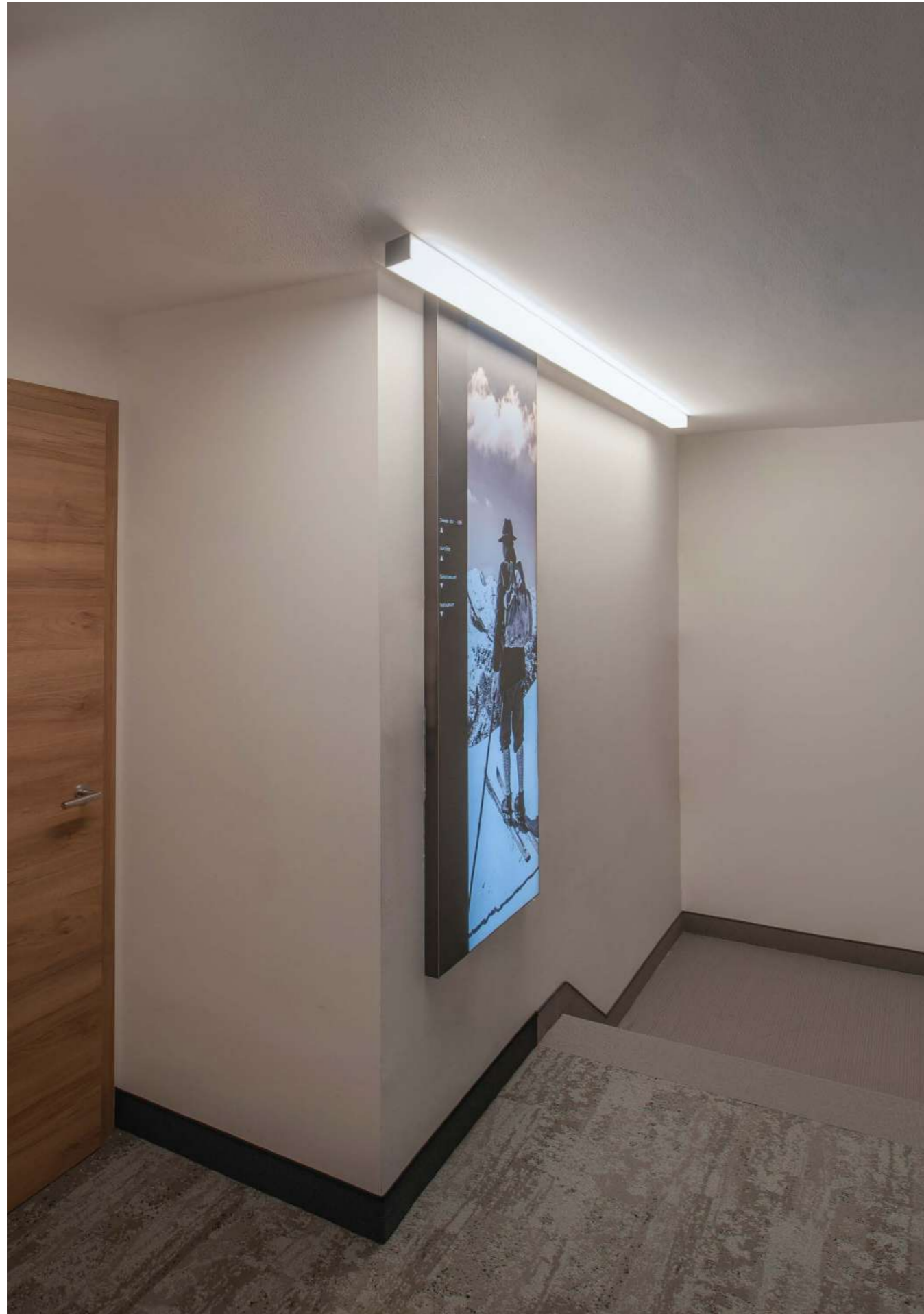

Hotel Christoph, Elmau, Austria, Photo: Joachim Rauch

THE LINE SD

THE LINE SD

220-240V AC 50/60Hz Design: INHOUSE

IP20

Aufbauleuchte aus stranggepresstem Aluminiumprofil · Enddeckel grau pulverbeschichtet · zweiseitig abstrahlende opale PMMA Abdeckung
 Surface luminaire made of extruded aluminium · end pieces grey powder coated · light emission on 2 sides, PMMA diffuser
 Plafone o da parete in alluminio estruso · tappi finali verniciata in polvere grigia · diffusore opale in PMMA, biemissione
 Plafonnier ou à paroi en aluminium extrudé · emboutes de fermeture vernissés a poudres gris · diffuseur opale en PMMA

CODE	SYS W	L mm	LUMEN
536-211WW8Y	17	601	1820 - 1910
536-212WW8Y	34	1163	3640 - 3820
536-213WW8Y	51	1731	5460 - 5730
536-214WW8Y	68	2293	7280 - 7640
536-215WW8Y	85	2861	9100 - 9550
536-216WW8Y	102	3423	10920 - 11460
536-217WW8Y	119	3991	12740 - 13370
536-218WW8Y	136	4553	14560 - 15280

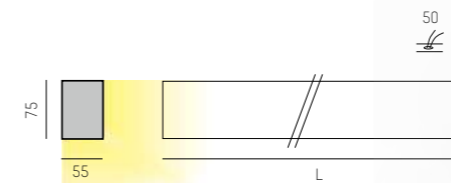

Sonderlängen auf Anfrage
 custom length upon request

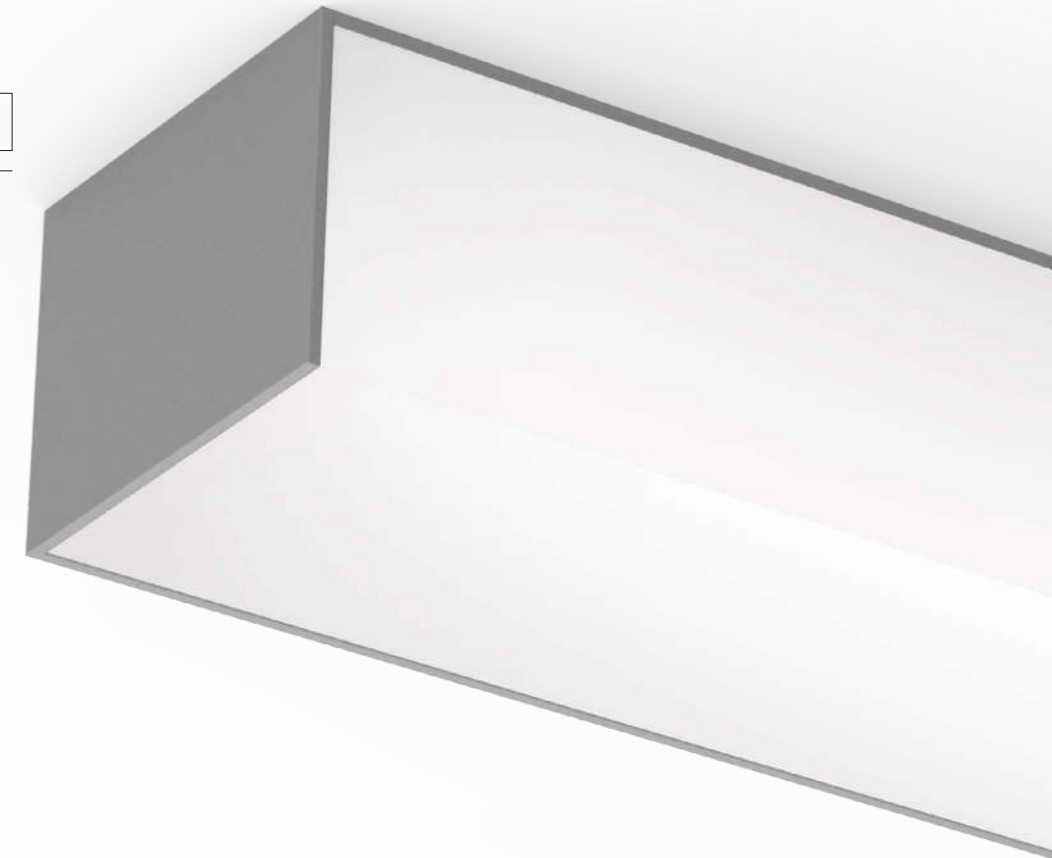

COMPLETE CODE	
WW = LIGHT COLOUR	Y = DIMMABLE
W3 LED 3000K = 19 CRI>80	Ⓢ switchable = no addition
W4 LED 4000K = 14 CRI>80	Ⓣ DALI dim = code + ddd



Private residence, Austria, Photo: Joachim Rauch

THE LINE SYSTEM

PROFILE

PROFIL SYSTEM PROFILE SYSTEM	LÄNGE LENGTH	PMMA ABDECKUNG OPAL PMMA COVER OPAL	LÄNGE LENGTH
536-22000	4600mm	536-23001	4600mm
536-22018	per running meter	536-23010	per running meter

ACHTUNG: Abdeckung, Lichteinsätze und Systemteile separat ordern
ATTENTION: order covers, light inserts and components separately

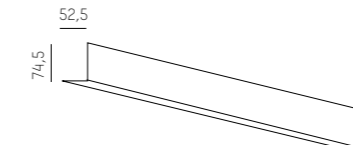
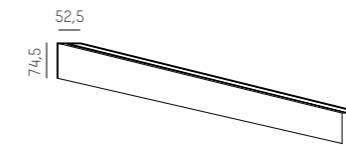

LIGHT INSERTS

IP20

Einspeisung durchgangsverdrahtet 1,5mm², steckfertig, inkl. Verbindungskabel, Achtung: Lumenwerte inkl. Abdeckung
Feed through wired 1,5mm², ready to plug in, incl. connector cable, Attention: Lumendata are with cover

LOW OUTPUT

CODE	SYS W	L mm	LUMEN
536-241WWY	17	567	1820 - 1910
536-242WWY	34	1129	3640 - 3820

HIGH OUTPUT

CODE	SYS W	L mm	LUMEN
536-241WWhY	23	567	2290 - 2400
536-242WWhY	45	1129	4580 - 4800

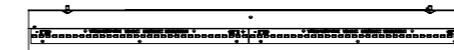

COMPLETE CODE

WW = LIGHT COLOUR	Y = DIMMABLE
LED 3000K = 19 CRI>80	switchable = no addition
LED 4000K = 14 CRI>80	DALI dim = code + ddd

COMPONENTS

EINSPEISUNG POWER FEED	KABEL CABLE	ENDECKELSET END PIECE SET	FARBE COLOUR	LINEARVERBINDER LINEAR JUNCTION
536-270	3 x 0,75mm ²	536-268		536-258
536-270d	5 x 0,75mm ²			

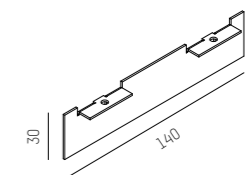
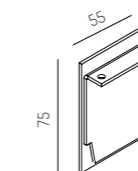
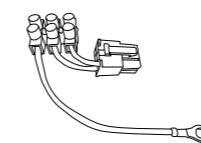

Set 2 Stk. inkl. Erdungskabel
set 2 pcs. incl. ground cable

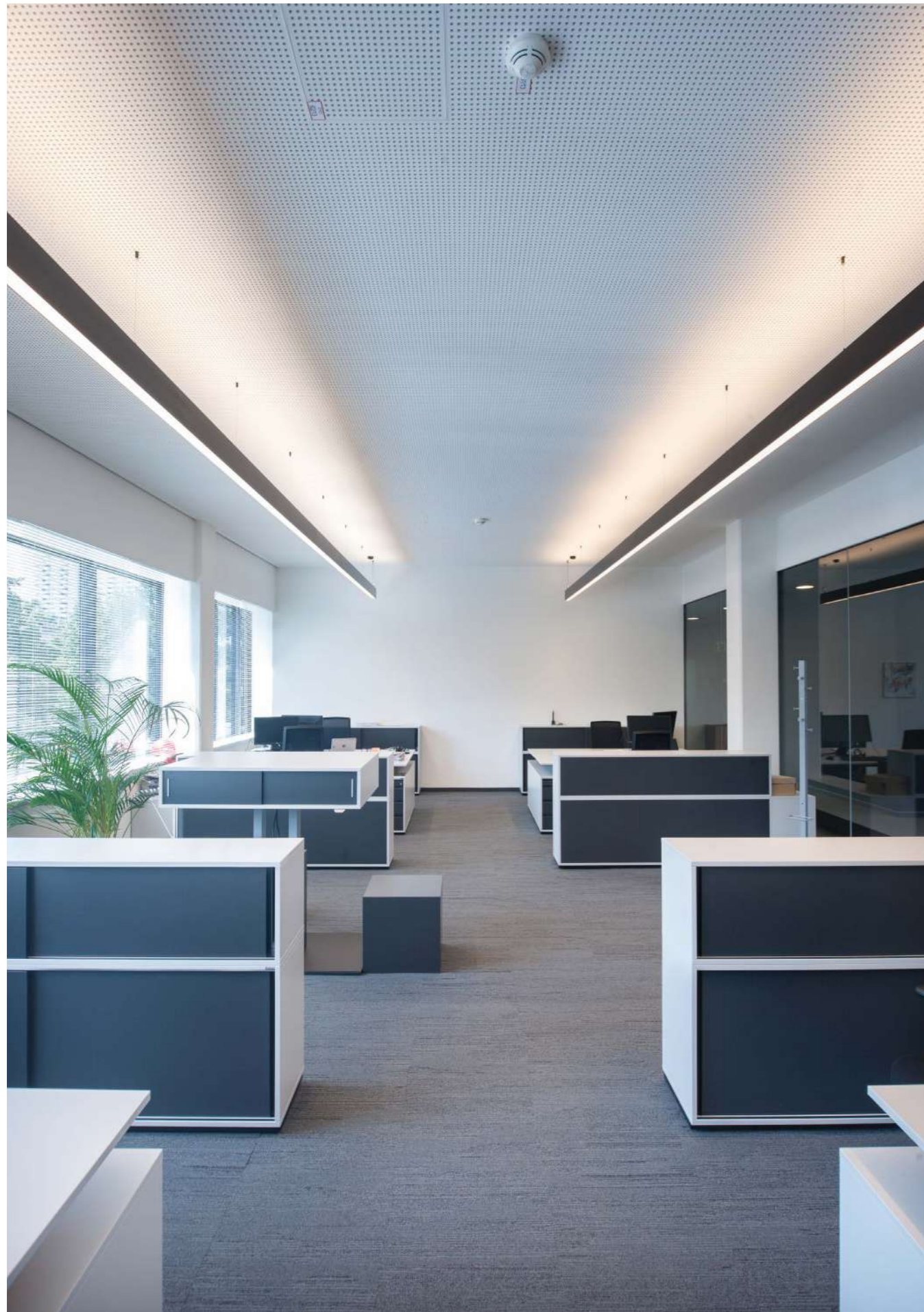

Hilti Headquarter, Vienna, Austria, Photo: Joachim Rauch

LOG UP/DOWN PDI

LOG OUT UP/DOWN PDI OPAL / MICROPRISMA IP20

220-240V AC 50/60Hz Design: INHOUSE

LED Pendelleuchte aus Aluminiumprofil · Oberfläche pulverbeschichtet oder eloxiert · Abdeckung mit Mikroprismenoptik oder Opaldiffusor
 LED pendant from aluminium profile · surface powder-coated or anodized · opal or microprismatic diffuser
 Sospensione con profilo in alluminio · superficie verniciata a polveri o anodizzata · diffusore opale o microprismatico
 Suspension en profilé d'aluminium · surface lacquée en poudre ou anodisée · diffuseur opal ou en microprisme

CODE	SYS W	L mm	LUMEN
581-401WXCCY	42	870	3500 - 3920
581-411WXCCY	54	1156	4670 - 5230
581-421WXCCY	68	1441	5840 - 6540
581-431WXCCY	108	2299	9350 - 10470
581-441WXCCY	136	2869	11690 - 13090
581-451WXCCY	162	3442	14030 - 15710
581-461WXCCY	202	4297	17540 - 19640

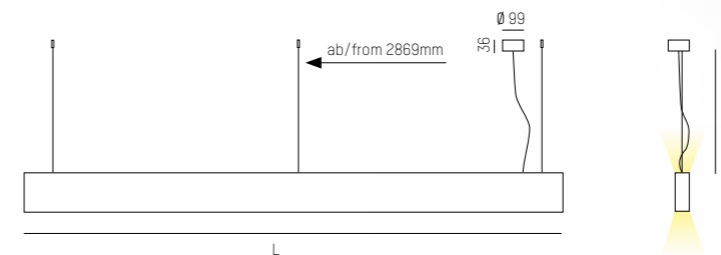
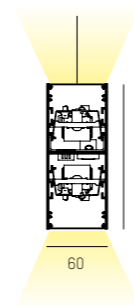

COMPLETE CODE			
W = LIGHT COLOUR	X = COLOUR	C = COVER	Y = DIMMABLE
LED 3000K = 9 CRI>80	white = 5	opal = pm	switchable = no addition
LED 4000K = 10 CRI>80	black = 6	microprismatic = mp UGR<19	DALI dim = code + ddd
	alu anodized = 8		

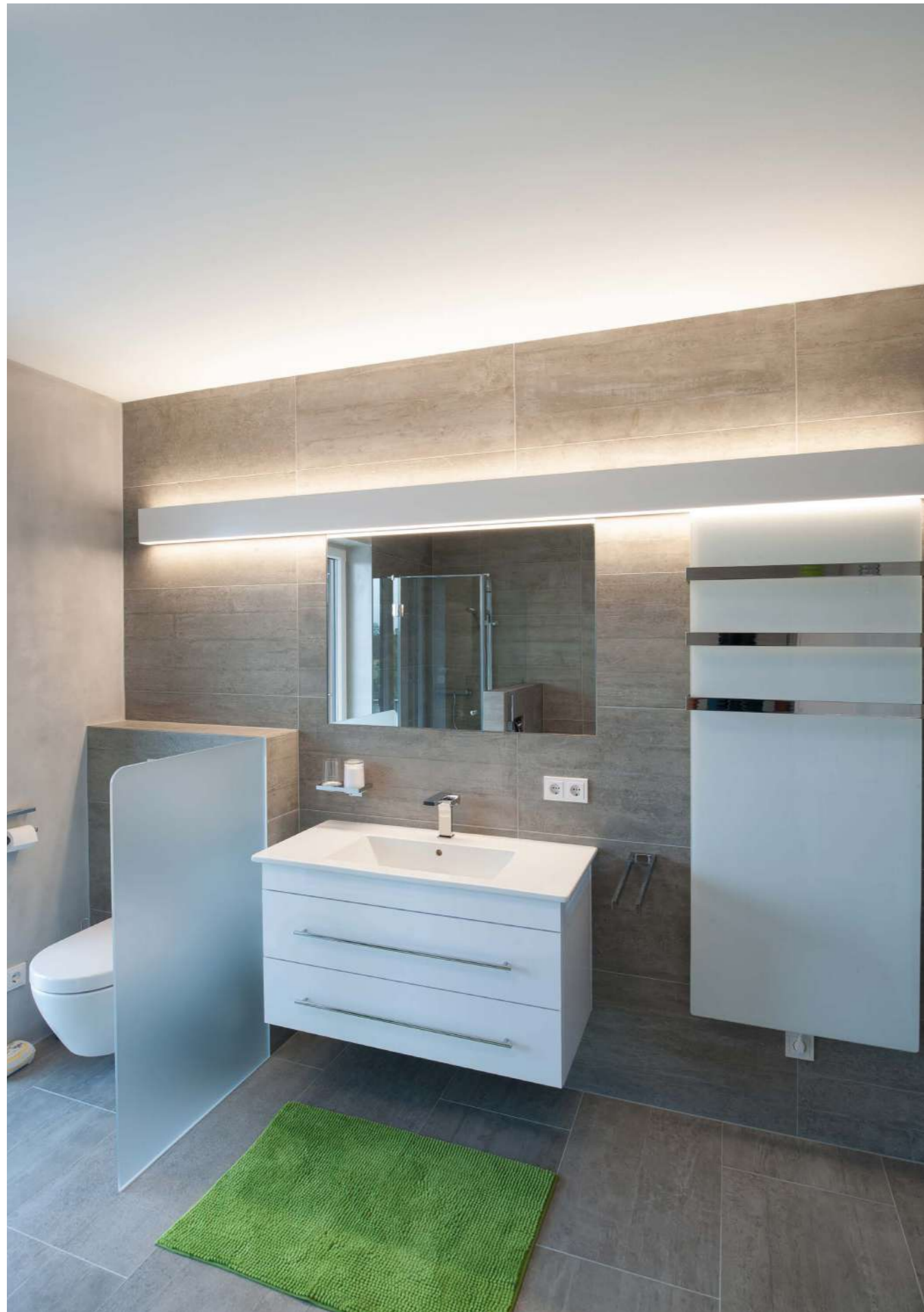

Private residence, Austria ,Photo: Joachim Rauch

LOG UP/DOWN W

LOG OUT UP/DOWN W OPAL / MICROPRISMA IP20

220-240V AC 50/60Hz Design: INHOUSE

LED Wandleuchte aus Aluminiumprofil · Oberfläche pulverbeschichtet oder eloxiert · Abdeckung mit Mikroprismenoptik oder Opaldiffusor
 LED wall luminaire from aluminium profile · surface powder-coated or anodized · opal or microprismatic diffuser
 Lampada a parete con profilo in alluminio · superficie verniciata a polveri o anodizzata · diffusore opale o microprismatico
 Applique LED en profilé d'aluminium · surface lacquée en poudre ou anodisée · diffuseur opal ou en microprisme

CODE	SYS W	L mm	LUMEN
581-40WXCCY	42	870	3500 - 3920
581-41WXCCY	54	1156	4670 - 5230
581-42WXCCY	68	1441	5840 - 6540
581-43WXCCY	108	2299	9350 - 10470
581-44WXCCY	136	2869	11690 - 13090
581-45WXCCY	162	3442	14030 - 15710
581-46WXCCY	202	4297	17540 - 19640

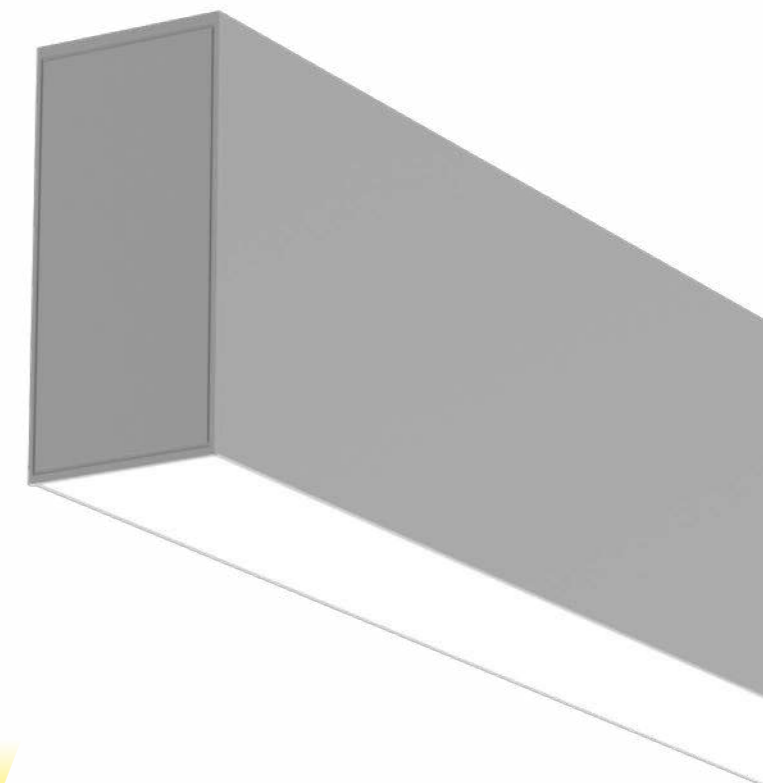
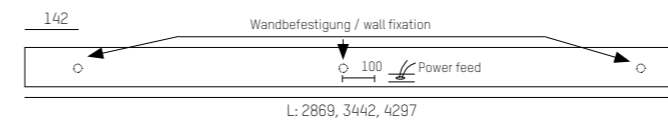
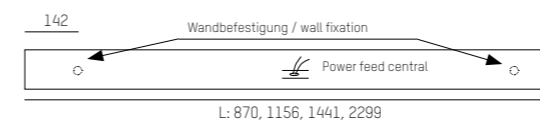
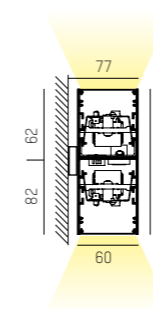

COMPLETE CODE			
W = LIGHT COLOUR	X = COLOUR	C = COVER	Y = DIMMABLE
LED 3000K = 9 CRI>80	white = 5	opal = pm	switchable = no addition
LED 4000K = 10 CRI>80	black = 6	microprismatic = mp UGR<19	DALI dim = code + ddd
	alu anodized = 8		

PROFILE

PROFILSYSTEM PROFILE SYSTEM	LÄNGE LENGHT	FÜR LICHTEINSATZ FOR LIGHT INSERT	PROFIL OBJEKT PROFILE OBJECT	LÄNGE LENGHT	ENDECKEL END PIECE	SET SET
581-2X583	583mm	SYS 2 x 15W	581-1X4500	4500mm	581-06X inkl. Erdungskabel incl. ground cable	2 pcs.
581-2X869	869mm	SYS 2 x 21W				
581-2X1155	1155mm	SYS 2 x 27W				
581-2X2300	2300mm	SYS 4 x 27W				
581-2X3445	3445mm	SYS 6 x 27W				
581-2X1440	1440mm	SYS 2 x 34W				
581-2X2870	2870mm	SYS 4 x 34W				
581-2X4300	4300mm	SYS 6 x 34W				

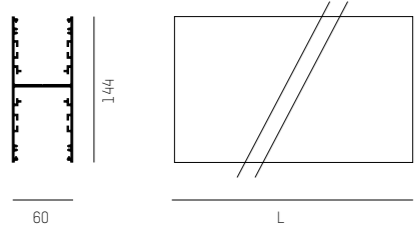
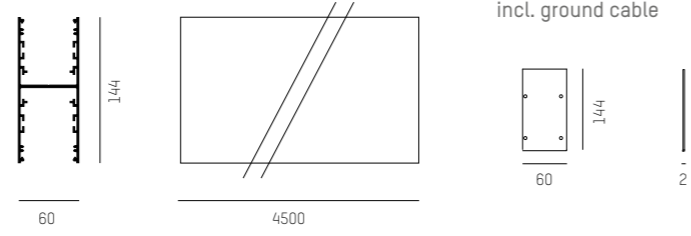

Abdeckungen, Lichteinsätze und Zubehör separat ordern
Order covers, light inserts and components separately



LOG OUT UP/DOWN SYSTEM

COMPLETE CODE FORPROFILE		
X = COLOUR		
w white = 5	s black = 6	AE alu anodized = 8

LIGHT INSERTS

LICHTEINSÄTZE LIGHT INSERTS	LÄNGE LENGHT	SYS SYS	LM LM
528-20WY	571mm	SYS 15W	1730 - 1830
528-24WY	857mm	SYS 21W	2600 - 2740
528-25WY	1143mm	SYS 27W	3470 - 3660
528-26WY	1428mm	SYS 34W	4340 - 4580

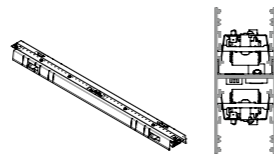

COMPLETE CODE FORPROFILE			
W = LIGHT COLOUR		Y = DIMMABLE	
w3 LED 3000K = 9 CRI>80	w4 LED 4000K = 10 CRI>80	Ⓢ switchable = no addition	Ⓣ DALI dim = code + ddd

3 CIRCUIT TRACK

SCHIENE TRACK	LÄNGE LENGHT
208-1910510X	1000mm
208-1910520X	2000mm
208-1910530X	3000mm

MONTAGESSET MOUNTING SET	FÜR FOR
581-09	3 circuit track

Distanz: jede 1000mm - 1 set
distance: every 1000mm - 1 set

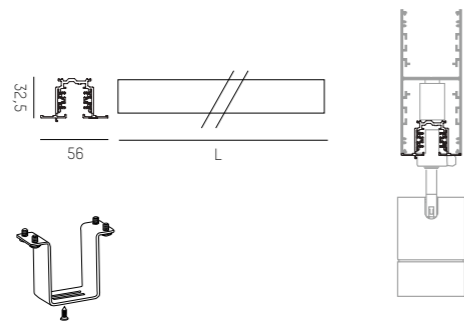

Zubehör für 3-Phasen Stromschiene: Seite 060-065
Components for 3-circuit track: page 060-065

COMPLETE CODE FORPROFILE		
X = COLOUR		
s black = 2	w white = 3	g grey = 5

LOG UP/DOWN SYSTEM

COVERS

MIKROPRISMA MICROPRISMA	LÄNGE LENGHT	PMMA OPAL PMMA OPAL	LÄNGE LENGHT	PMMA KLAR PMMA CLEAR	LÄNGE LENGHT	ALUMINIUMABDECKUNG ALUMINIUM COVER	LÄNGE LENGHT
528-970583	582mm	528-405583	582mm	581-980583	582mm	528-27X3200	3200mm
528-970869	868mm	528-405869	868mm	528-980869	868mm		
528-9701155	1154mm	528-4051155	1154mm	528-9801155	1154mm		
528-9701440	1439mm	528-4051440	1439mm	528-9801440	1439mm		
528-9702300	2298mm	528-4052300	2298mm	528-9802300	2298mm		
528-9702870	2869mm	528-4052870	2869mm	528-9802870	2869mm		
528-9703445	3443mm	528-4053445	3443mm	528-9803445	3443mm		
528-9704300	4298mm	528-4054300	4298mm	528-9804300	4298mm		
528-9704500	4500mm	528-1804500	4500mm	528-9804500	4500mm		

COMPONENTS

90° VERBINDER 90° JUNCTION	LÄNGE LENGHT	LINEARVERBINDER LINEAR JUNCTION	LÄNGE LENGHT	WANDMONTAGESSET WALL MOUNTING SET	LÄNGE LENGHT
581-01X	100mm	581-03	140mm	581-109	140mm
inkl. Aluminiumabdeckung incl. aluminium cover		innenliegend in board		Distanz: je 1000mm - 1 set distance: every 1000mm - 1 set	

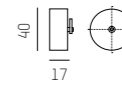
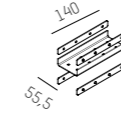
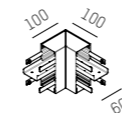

ABHÄNGUNG SUSPENSION	LÄNGE LENGHT	BALDACHIN CANOPY	FARBE COLOUR	EINSPEISEKABEL POWER FEED CABLE	DIMENSION DIMENSION
581-041X	max. 3000mm	301-212000000400	grey	301-k1547b2	3 x 0,75mm / L: 1750mm
Distanz: max. 800mm distance: max. 800mm		301-212000000500	white	301-k1547b1	3 x 0,75mm / L: 3150mm
		301-212000000600	black	301-k1627b2	3 x 1,50mm / L: 1750mm
		Einspeisekabel separat ordern order power feed cable separately		301-k1627b1	3 x 1,50mm / L: 3150mm
				301-k1787b2	5 x 0,75mm / L: 1750mm
				301-k1787b1	5 x 0,75mm / L: 3150mm
				301-k1867b2	5 x 1,50mm / L: 1750mm
				301-k1867b1	5 x 1,50mm / L: 3150mm
				Transparent, für Baldachin inkl. Kabelbefestigungsringe transparent, for canopy incl. cable fixing rings	

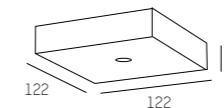

ERDUNGSSET EARTHING SET
581-05

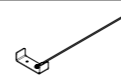

COMPLETE CODE FORPROFILE		
X = COLOUR		
w white = 5	s black = 6	AE alu anodized = 8

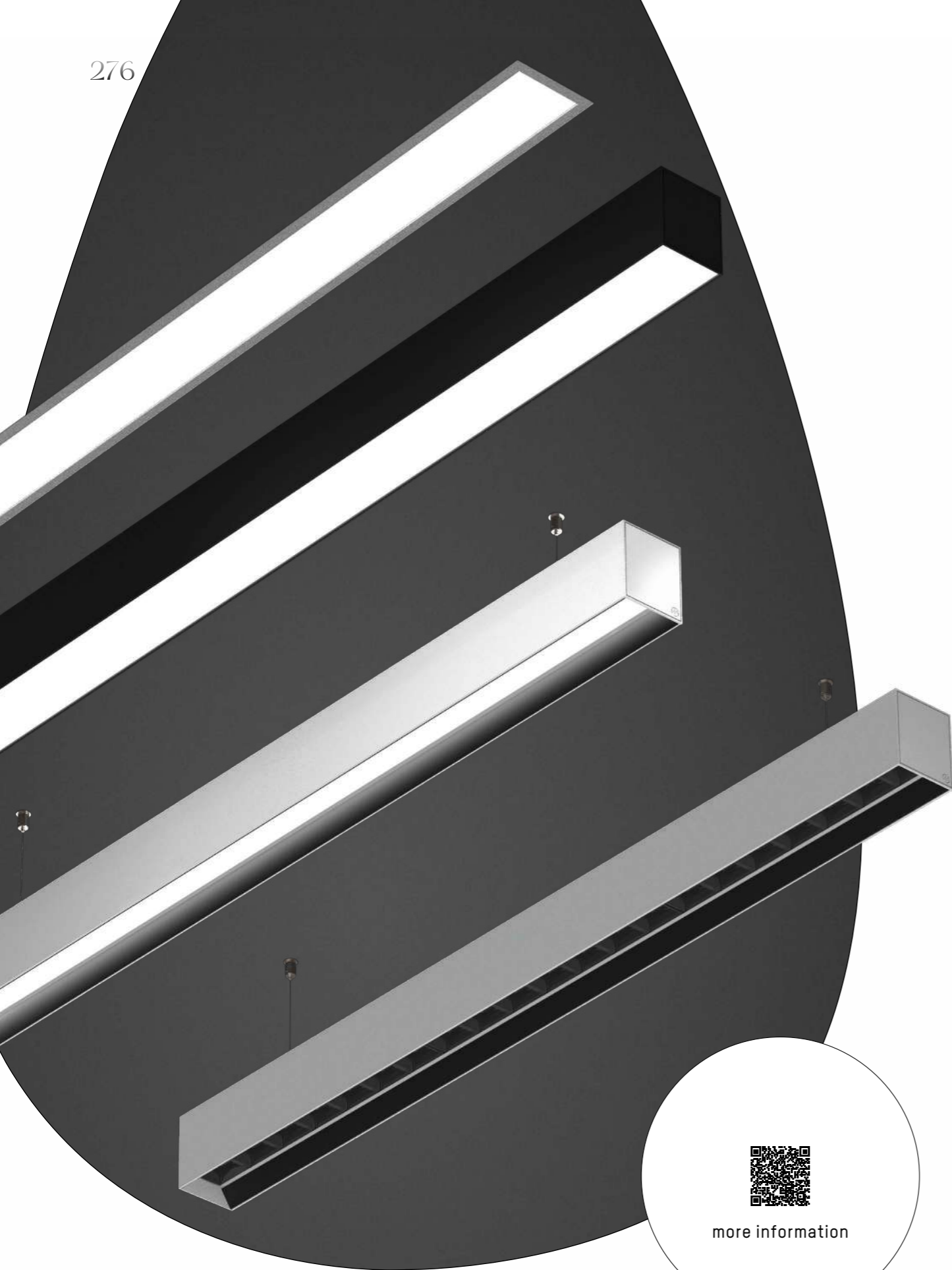

more information

LOG 2.1



Dr. Hirsch, Tiefenbach, Germany, Photo: Joachim Rauch



Dormakaba, Seekirchen, Austria, Photo: Joachim Rauch



Wiesner & Hager, Graz, Austria, Photo: Joachim Rauch

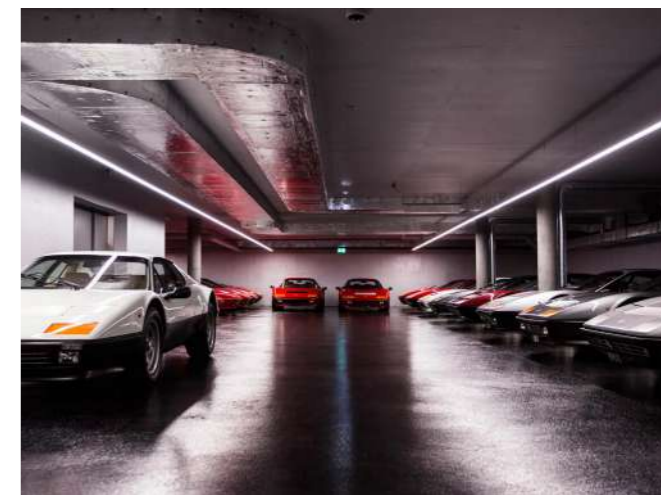

Niki Hasler AG, Cham, Switzerland, Photo: Sir Heian AG



Kulturgarage, Vienna, Austria, Photo: Joachim Rauch



Truckcenter Katzinger, Altenfelden, Austria, Leibez Interieur Design, Photo: Stöbich



Mercedes-Benz Showroom Veho Vehkala
Helsinki, Finland
Photo: Kim Forssen

LOG 2.1

PERFECT FOR EVERY LIGHTING SOLUTION

LOG 2.1 ist als Pendel-, Aufbau- und Einbauleuchte erhältlich. Durch die schlichte, geradlinige Optik integriert sich die LOG Serie als großartige Beleuchtungslösung zurückhaltend und dennoch markant in jegliche Architektur. Das modulare System bietet ergänzende Komponenten, die perfekt mit dem Profil kombinierbar sind. Die Lichteinsätze mit opaler oder mikroprismatischer Abdeckung sowie die neuen BINA Einsätze welche sowohl UGR<19 als auch Ballwurfsicher sind eignen sich perfekt als Grundbeleuchtung. Für das LOG OUT 2.1, LOG IN 2.1 & LOG IN TRIMMLESS 2.1 System können der Rogga Einsatz sowie der Strahler MOVA als zusätzliches Beleuchtungselement verwendet werden.

LOG 2.1 is available as pendant, surface-mounted and recessed luminaires. Due to its simple, straightforward look, the LOG series can be integrated discretely, yet distinctively into any style of architecture as a great lighting solution. The modular system offers additional components which can be perfectly combined with the profile. The lighting inserts with opal or microprismatic covers as well as the new BINA inserts which are available as UGR<19 and as ball-proof version, are just perfect as basic lighting. The Rogga insert and the MOVA spotlight can be used as additional lighting elements for the LOG OUT 2.1, LOG IN 2.1 & LOG IN TRIMMLESS 2.1 system.

Design: INHOUSE

VARIATIONS

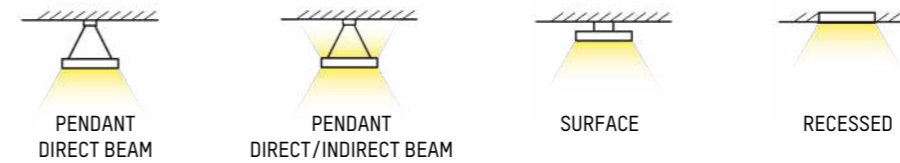

PROFILE



FORM



LED COLOURS



CORE COLOURS

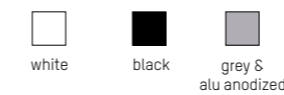

COVER OPTIONS



LOG OUT 2.1 PD

LOG OUT 2.1 PD OPAL / MICROPRISMA IP20 

220-240V AC 50/60Hz Design: INHOUSE

LED Pendelleuchte aus Aluminiumprofil · Oberfläche pulverbeschichtet oder eloxiert · Abdeckung mit Mikroprismenoptik oder Opaldiffusor
 LED pendant from aluminium profile · surface powder-coated or anodized · opal or microprismatic diffuser
 Sospensione con profilo in alluminio · superficie verniciata a polveri o anodizzata · diffusore opale o microprismatico
 Suspension en profilé d'aluminium · surface lacquée en poudre ou anodisée · diffuseur opal ou en microprisme

CODE	SYS W	L mm	LUMEN
728-20104LCWWXXY	16 / 31	1131	1940 - 3930
728-20105LCWWXXY	20 / 40	1411	2430 - 4920
728-20106LCWWXXY	32 / 62	2255	3880 - 7860
728-20107LCWWXXY	40 / 80	2816	4860 - 9840
728-20108LCWWXXY	48 / 93	3379	5820 - 11790
728-20109LCWWXXY	60 / 120	4220	7290 - 14760

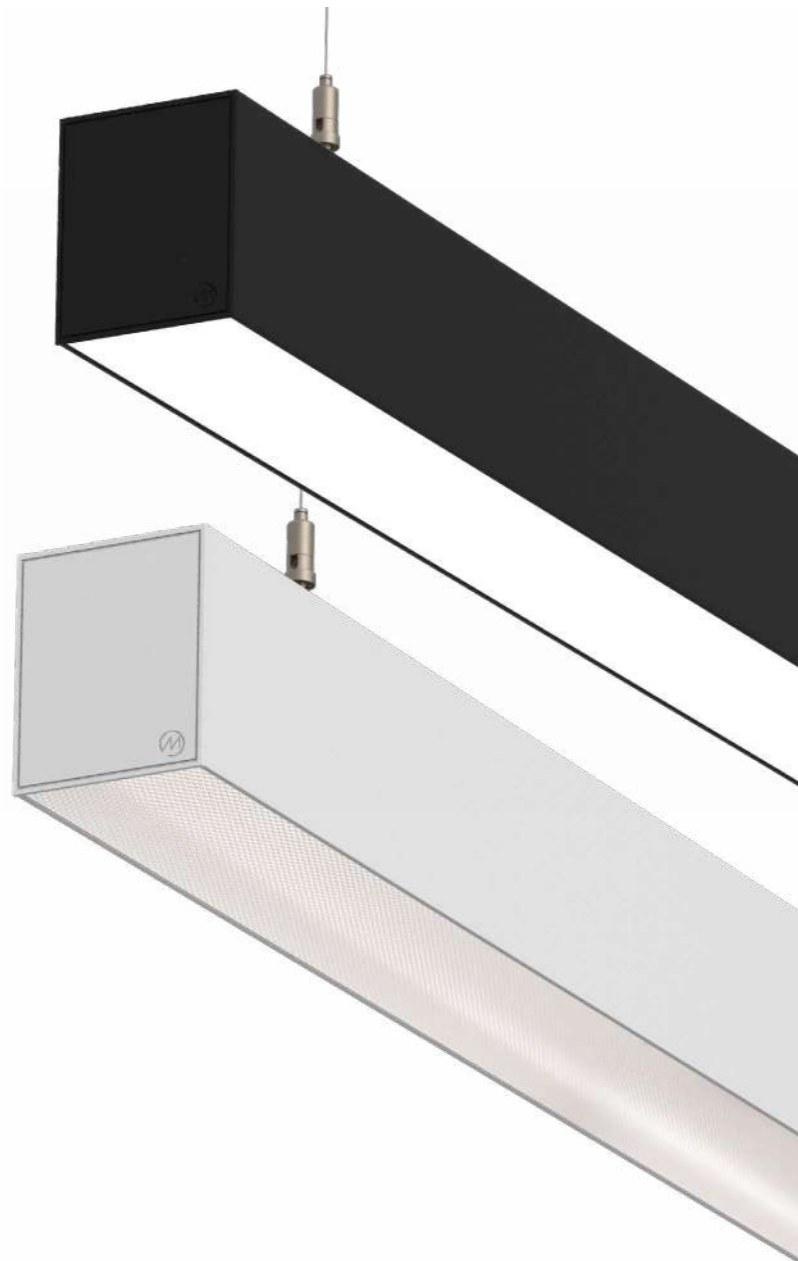
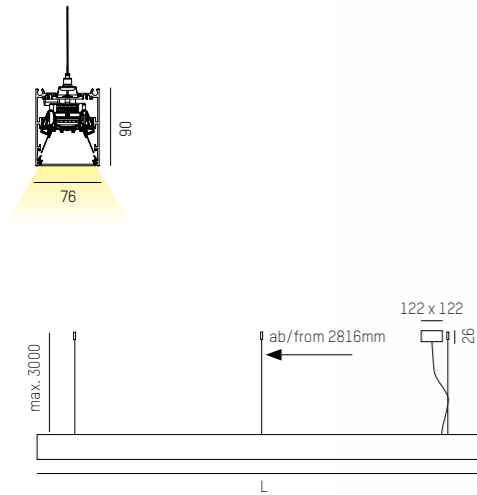

COMPLETE CODE				
L = LIGHT INSERT	C = COVER	WW = LIGHT COLOUR	XX = COLOUR	Y = DIMMABLE
MID OUTPUT = 1	opal = 1	LED 2700K = 13 CRI>80	white = 50	switchable = 0
HIGH OUTPUT = 3	microprismatic foil = 8	LED 3000K = 19 CRI>80	black = 60	DALI dim = d
	UGR<19 (only MID OUTPUT)	LED 4000K = 14 CRI>80	alu anodized = 80	

LOG OUT 2.1 BINA LENS PD IP20 

220-240V AC 50/60Hz Design: INHOUSE UGR<19

LED Pendelleuchte aus Aluminiumprofil · Oberfläche pulverbeschichtet oder eloxiert · schwarzer Lichteinsatz mit Linseneinsatz
 LED pendant from aluminium profile · surface powder-coated or anodized · black light insert with lens insert
 Sospensione con profilo in alluminio · superficie verniciata a polveri o anodizzata · inserto a luce nera con lente
 Suspension en profilé d'aluminium · surface lacquée en poudre ou anodisée · insert de lumière noire avec lentille

CODE	SYS W	L mm	LUMEN
728-2070436WWXXY	43	1131	4370 - 4650
728-2070636WWXXY	86	2255	8740 - 9300
728-2070836WWXXY	129	3379	13110 - 13950

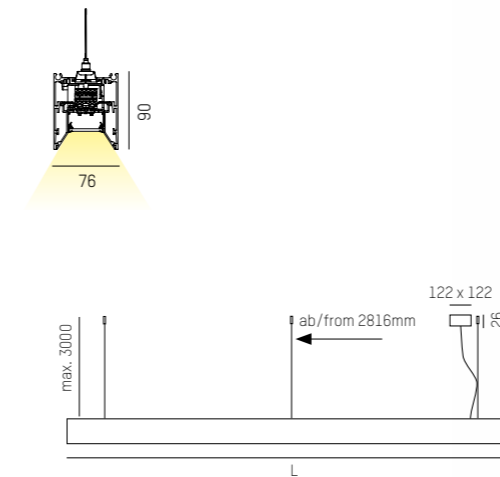

COMPLETE CODE		
WW = LIGHT COLOUR	XX = COLOUR	Y = DIMMABLE
LED 2700K = 13 CRI>80	white = 56	switchable = 0
LED 3000K = 19 CRI>80	black = 66	DALI dim = d
LED 4000K = 14 CRI>80	alu anodized = 86	

LOG OUT 2.1 PD

LOG OUT 2.1 BINA PD

220-240V AC 50/60Hz Design: INHOUSE

IP20

LED Pendelleuchte aus Aluminiumprofil · Oberfläche pulverbeschichtet oder eloxiert · Lichteinsätze schwarz oder weiß mit Opaldiffusor
 LED pendant from aluminium profile · surface powder-coated or anodized · light inserts black or white with opal diffuser
 Sospensione con profilo in alluminio · superficie verniciata a polveri o anodizzata · inserti luminosi neri o bianchi con diffusore opale
 Suspension en profilé d'aluminium · surface lacquée en poudre ou anodisée · inserts lumineux noirs ou blancs avec diffuseur opal

CODE	SYS W	L mm	LUMEN
728-20204L1WWXXY	16 / 31	1131	1510 - 4120
728-20205L1WWXXY	20 / 40	1411	1890 - 5150
728-20206L1WWXXY	32 / 62	2255	3020 - 8240
728-20207L1WWXXY	40 / 80	2816	3780 - 10300
728-20208L1WWXXY	48 / 93	3379	4530 - 12360
728-20209L1WWXXY	60 / 120	4220	5670 - 15450

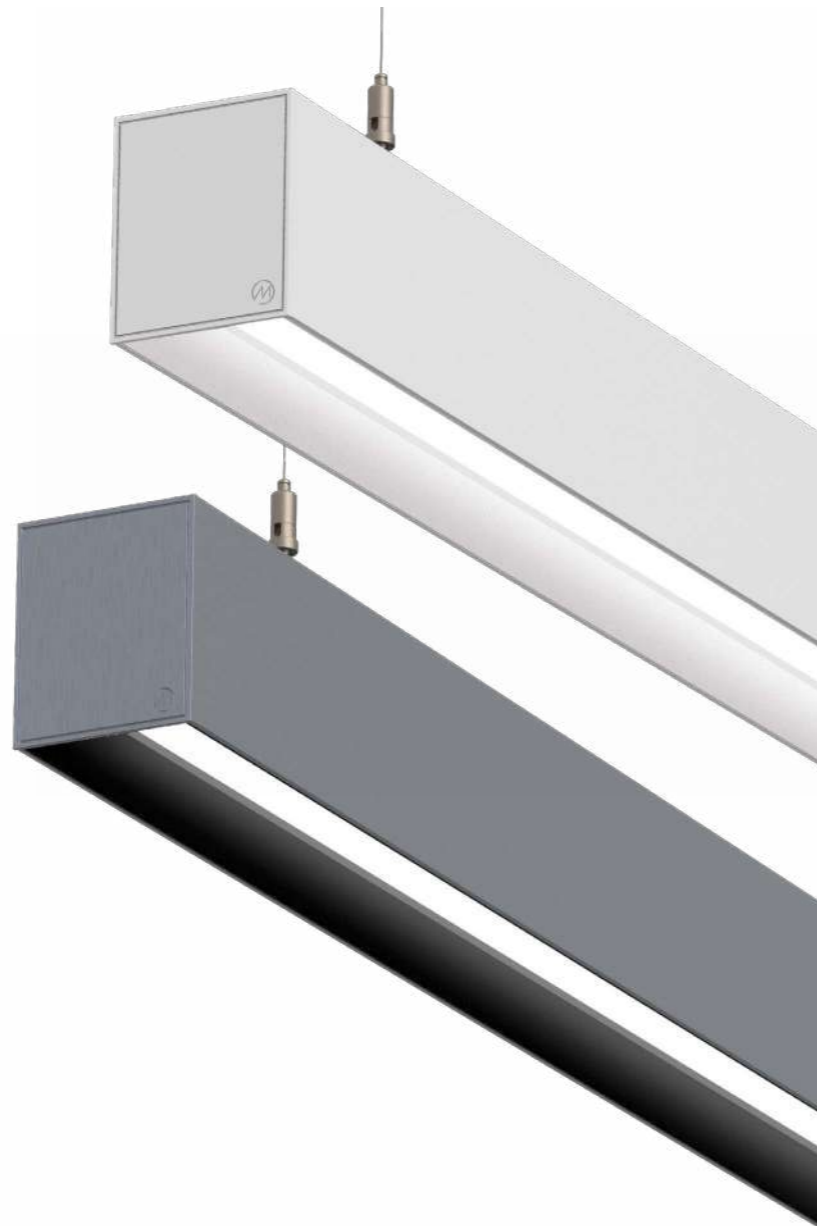
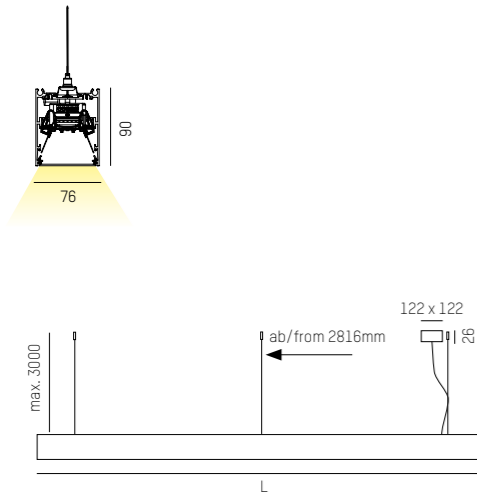

COMPLETE CODE				
L = LIGHT INSERT	WW = LIGHT COLOUR	X = COLOUR PROFILE	X = COLOUR LIGHT INSERT	Y = DIMMABLE
MID OUTPUT = 1	LED 2700K = 13 CRI>80	white = 5	white = 5	switchable = 0
HIGH OUTPUT = 3	LED 3000K = 19 CRI>80	black = 6	black = 6	DALI dim = d
	LED 4000K = 14 CRI>80	alu anodized = 8		

PRODUCTS

LOG OUT 2.1 BINA OFFICE PD

220-240V AC 50/60Hz Design: INHOUSE UGR<19

IP20

LED Pendelleuchte aus Aluminiumprofil · Oberfläche pulverbeschichtet oder eloxiert · schwarzer Lichteinsatz mit Mikroprismenoptik
 LED pendant from aluminium profile · surface powder-coated or anodized · black light insert with microprismatic diffuser
 Sospensione con profilo in alluminio · superficie verniciata a polveri o anodizzata · inserto a luce nera con ottica a microprismi
 Suspension en profilé d'aluminium · surface lacquée en poudre ou anodisée · insert de lumière noire avec optique à microprisme

CODE	SYS W	L mm	LUMEN
728-2020432WWXXY	34	1131	2750 - 2960
728-2020532WWXXY	41	1411	3440 - 3700
728-2020632WWXXY	68	2255	5500 - 5920
728-2020732WWXXY	82	2816	6880 - 7400
728-2020832WWXXY	102	3379	8250 - 8880
728-2020932WWXXY	123	4220	10320 - 11100

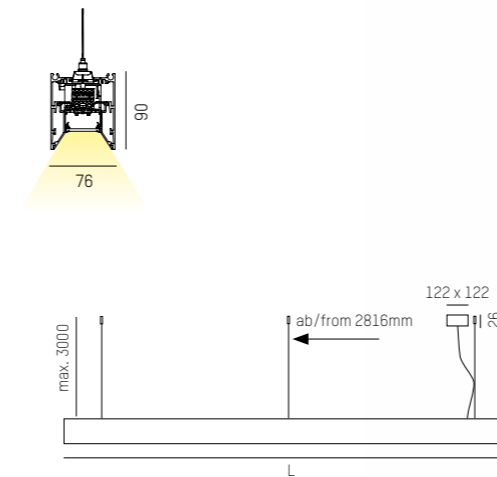

COMPLETE CODE		
WW = LIGHT COLOUR	XX = COLOUR	Y = DIMMABLE
LED 2700K = 13 CRI>80	white = 56	switchable = 0
LED 3000K = 19 CRI>80	black = 66	DALI dim = d
LED 4000K = 14 CRI>80	alu anodized = 86	

PRODUCTS

LOG OUT 2.1 PDI

LOG OUT 2.1 PDI OPAL / MICROPRISMA IP20 

220-240V AC 50/60Hz Design: INHOUSE

LED Pendelleuchte aus Aluminiumprofil · Oberfläche pulverbeschichtet oder eloxiert · Abdeckung mit Mikroprismenoptik oder Opaldiffusor
 LED pendant from aluminium profile · surface powder-coated or anodized · opal or microprismatic diffuser
 Sospensione con profilo in alluminio · superficie verniciata a polveri o anodizzata · diffusore opale o microprismatico
 Suspension en profilé d'aluminium · surface lacquée en poudre ou anodisée · diffuseur opal ou en microprisme

CODE	SYS W	L mm	LUMEN
728-20104LCWWXXY	31 / 64	1131	4100 - 8590
728-20105LCWWXXY	39 / 79	1411	5130 - 10740
728-20106LCWWXXY	62 / 128	2255	8200 - 17180
728-20107LCWWXXY	78 / 158	2816	10260 - 21480
728-20108LCWWXXY	93 / 192	3379	12300 - 25770
728-20109LCWWXXY	117 / 237	4220	15390 - 32220

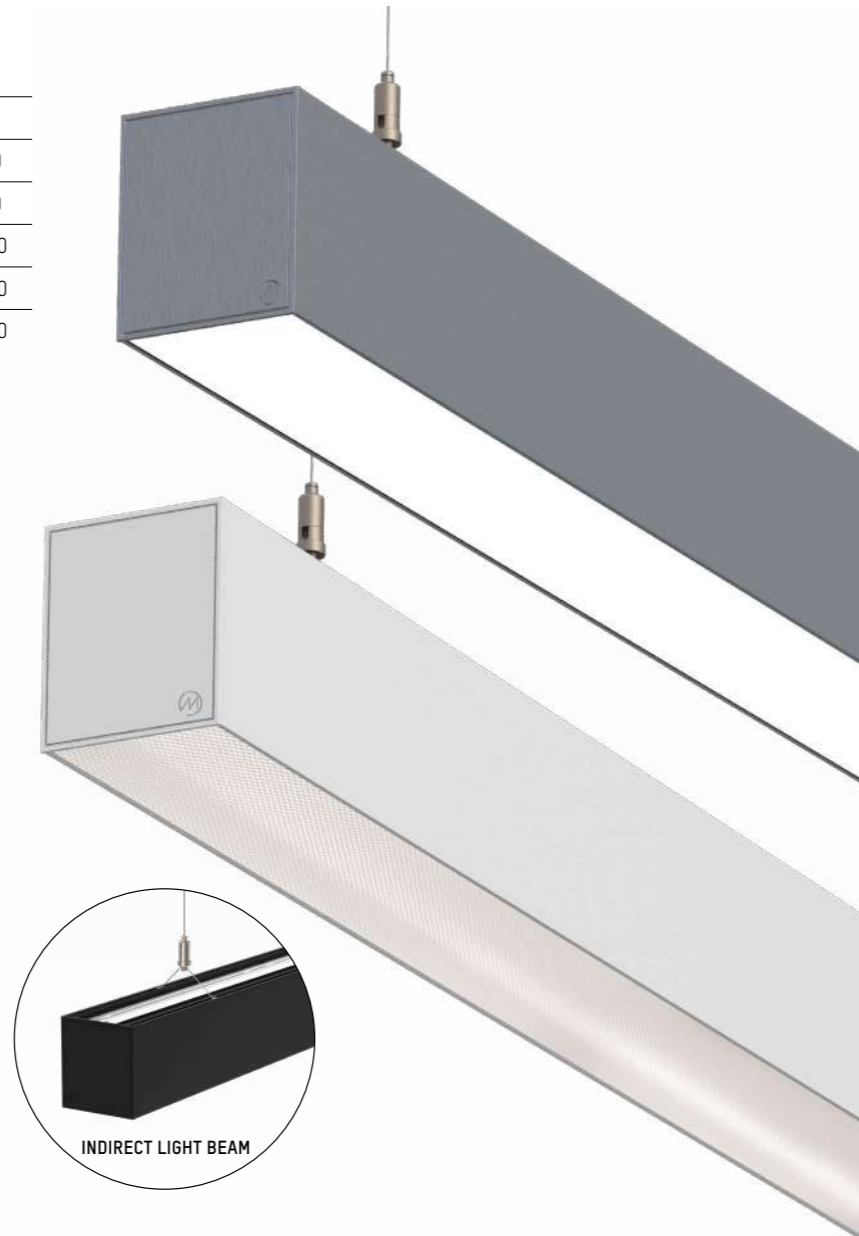
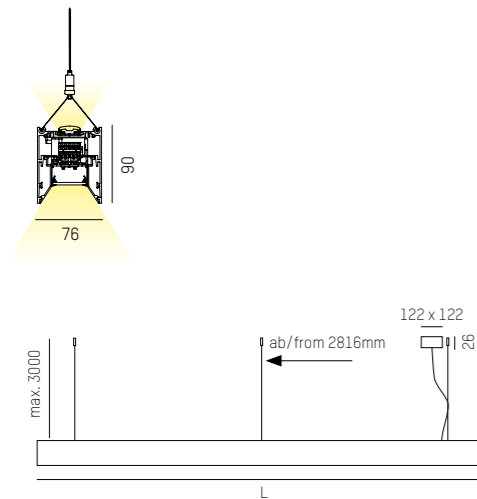

COMPLETE CODE				
L = LIGHT INSERT	C = COVER	WW = LIGHT COLOUR	XX = COLOUR	Y = DIMMABLE
MID OUTPUT = 2	opal = 1	LED 2700K = 13 CRI>80	white = 50	switchable = 0
HIGH OUTPUT = 4	microprismatic foil = 8	LED 3000K = 19 CRI>80	black = 60	DALI dim = d
	UGR<19 (only MID OUTPUT)	LED 4000K = 14 CRI>80	alu anodized = 80	

LOG OUT 2.1 BINA LENS PDI IP20 

220-240V AC 50/60Hz Design: INHOUSE UGR<19

LED Pendelleuchte aus Aluminiumprofil · Oberfläche pulverbeschichtet oder eloxiert · schwarzer Lichteinsatz mit Linseneinsatz
 LED pendant from aluminium profile · surface powder-coated or anodized · black light insert with lens insert
 Sospensione con profilo in alluminio · superficie verniciata a polveri o anodizzata · inserto a luce nera con lente
 Suspension en profilé d'aluminium · surface lacquée en poudre ou anodisée · insert de lumière noire avec lentille

CODE	SYS W	L mm	LUMEN
728-2070446WWXXY	76	1131	8530 - 9130
728-2070646WWXXY	152	2255	17060 - 18260
728-2070846WWXXY	228	3379	25590 - 27390

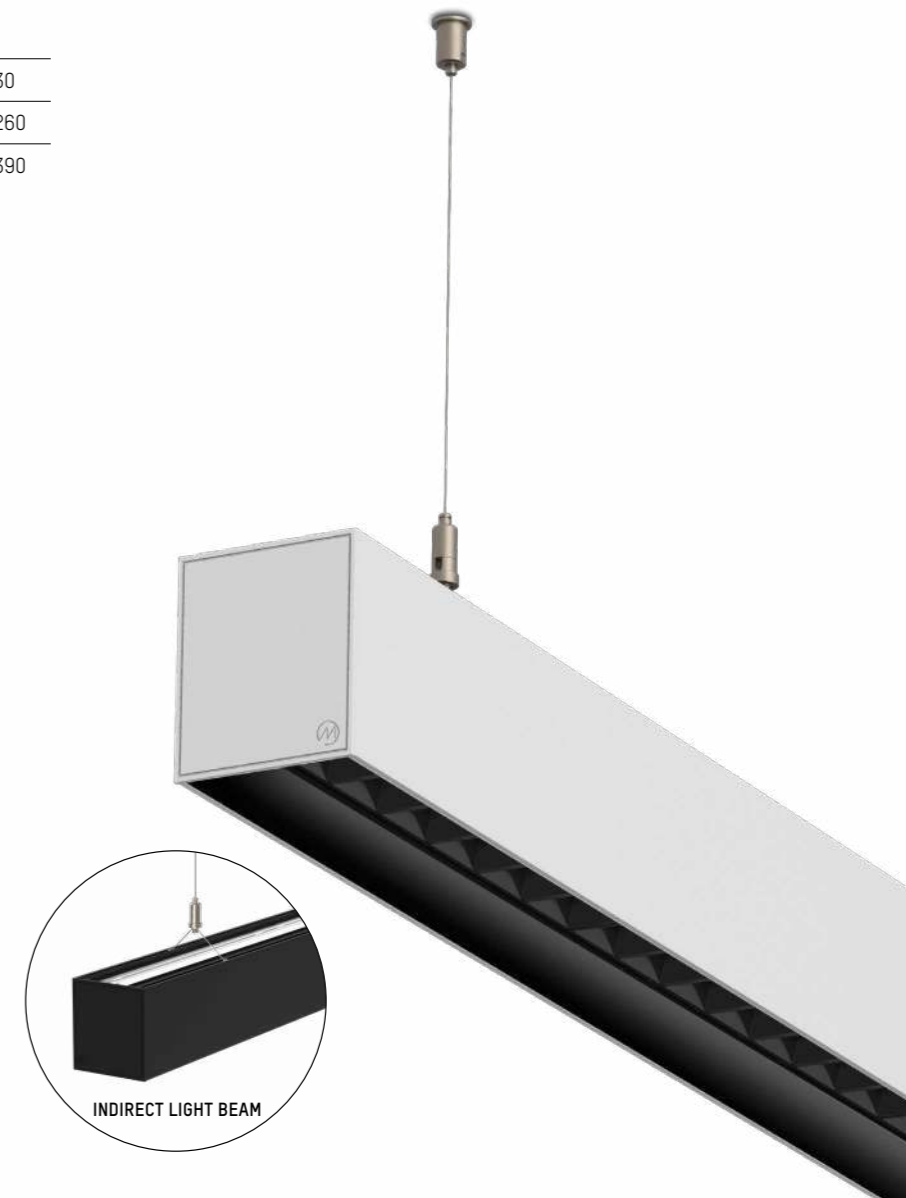
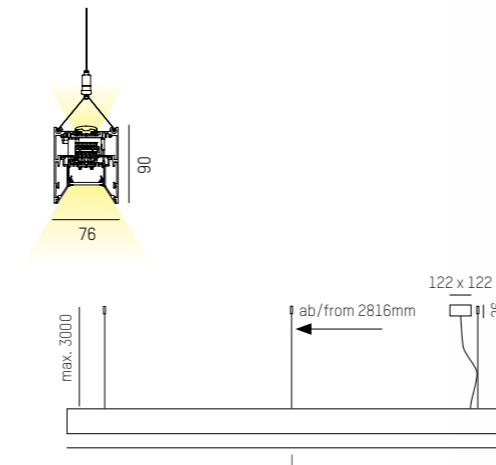

COMPLETE CODE		
WW = LIGHT COLOUR	XX = COLOUR	Y = DIMMABLE
LED 2700K = 13 CRI>80	white = 56	switchable = 0
LED 3000K = 19 CRI>80	black = 66	DALI dim = d
LED 4000K = 14 CRI>80	alu anodized = 86	

LOG OUT 2.1 PDI

LOG OUT 2.1 BINA PDI

220-240V AC 50/60Hz Design: INHOUSE

IP20

LED Pendelleuchte aus Aluminiumprofil · Oberfläche pulverbeschichtet oder eloxiert · Lichteinsätze schwarz oder weiß mit Opaldiffusor
 LED pendant from aluminium profile · surface powder-coated or anodized · light inserts black or white with opal diffuser
 Sospensione con profilo in alluminio · superficie verniciata a polveri o anodizzata · inserti luminosi neri o bianchi con diffusore opale
 Suspension en profilé d'aluminium · surface lacquée en poudre ou anodisée · inserts lumineux noirs ou blancs avec diffuseur opal

CODE	SYS W	L mm	LUMEN
728-20204L1 WWXXY	31 / 64	1131	3670 - 8600
728-20205L1 WWXXY	39 / 79	1411	4590 - 10750
728-20206L1 WWXXY	62 / 128	2255	7340 - 17200
728-20207L1 WWXXY	78 / 158	2816	9180 - 21500
728-20208L1 WWXXY	93 / 192	3379	11010 - 25800
728-20209L1 WWXXY	117 / 237	4220	13770 - 32250

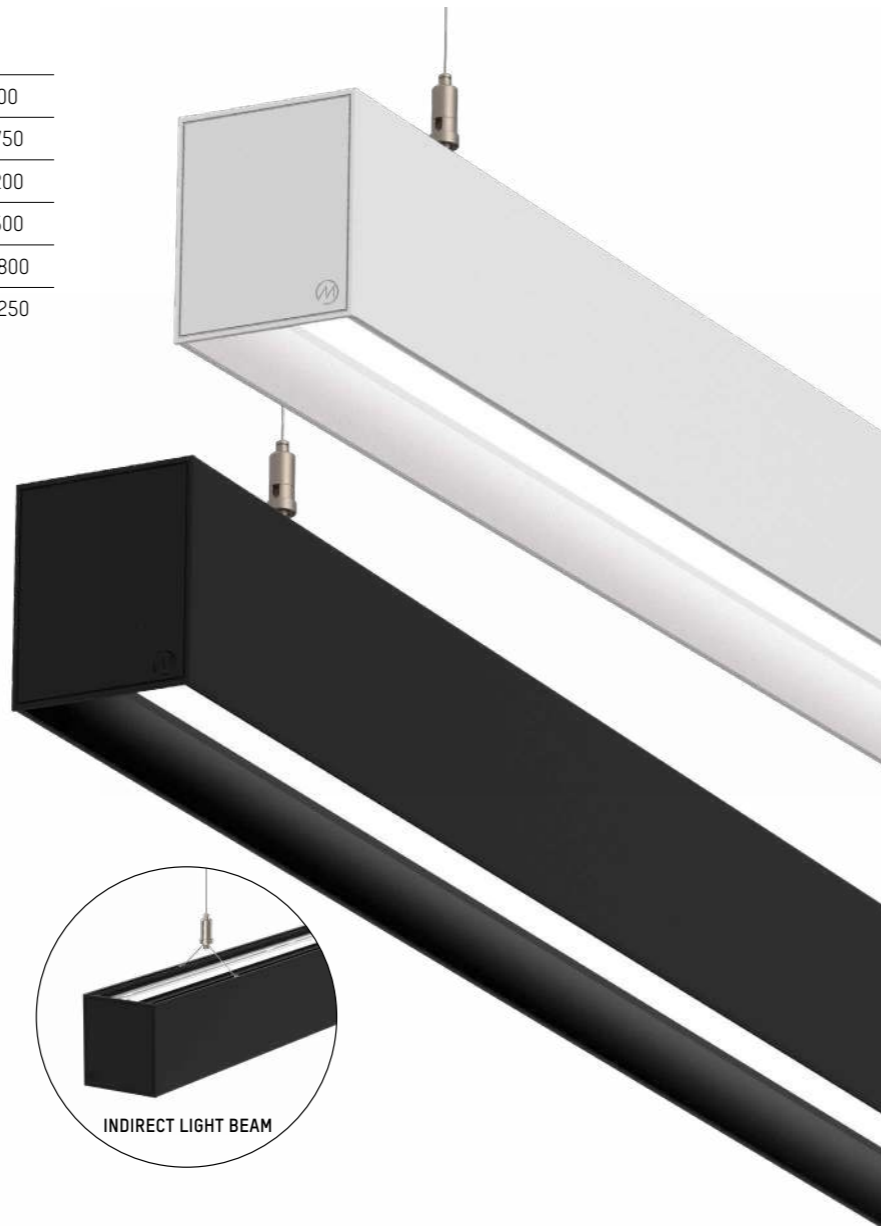
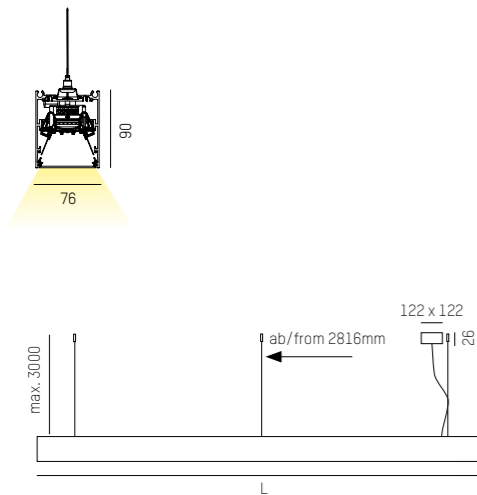

COMPLETE CODE				
L = LIGHT INSERT	WW = LIGHT COLOUR	X = COLOUR PROFILE	X = COLOUR LIGHT INSERT	Y = DIMMABLE
MO MID OUTPUT = 2	W2 LED 2700K = 13 CRI>80	W white = 5	W white = 5	S switchable = 0
HO HIGH OUTPUT = 4	W3 LED 3000K = 19 CRI>80	S black = 6	S black = 6	D DALI dim = d
	W4 LED 4000K = 14 CRI>80	AE alu anodized = 8		

LOG OUT 2.1 BINA OFFICE PDI

220-240V AC 50/60Hz Design: INHOUSE **UGR<19**

IP20

LED Pendelleuchte aus Aluminiumprofil · Oberfläche pulverbeschichtet oder eloxiert · schwarzer Lichteinsatz mit Mikroprismenoptik
 LED pendant from aluminium profile · surface powder-coated or anodized · black light insert with microprismatic diffuser
 Sospensione con profilo in alluminio · superficie verniciata a polveri o anodizzata · inserto a luce nera con ottica a microprismi
 Suspension en profilé d'aluminium · surface lacquée en poudre ou anodisée · insert de lumière noire avec optique à microprisme

CODE	SYS W	L mm	LUMEN
728-2020442 WWXXY	68	1131	7140 - 7670
728-2020542 WWXXY	84	1411	8930 - 9590
728-2020642 WWXXY	136	2255	14280 - 15340
728-2020742 WWXXY	168	2816	17860 - 19180
728-2020842 WWXXY	204	3379	21420 - 23010
728-2020942 WWXXY	252	4220	26790 - 28770

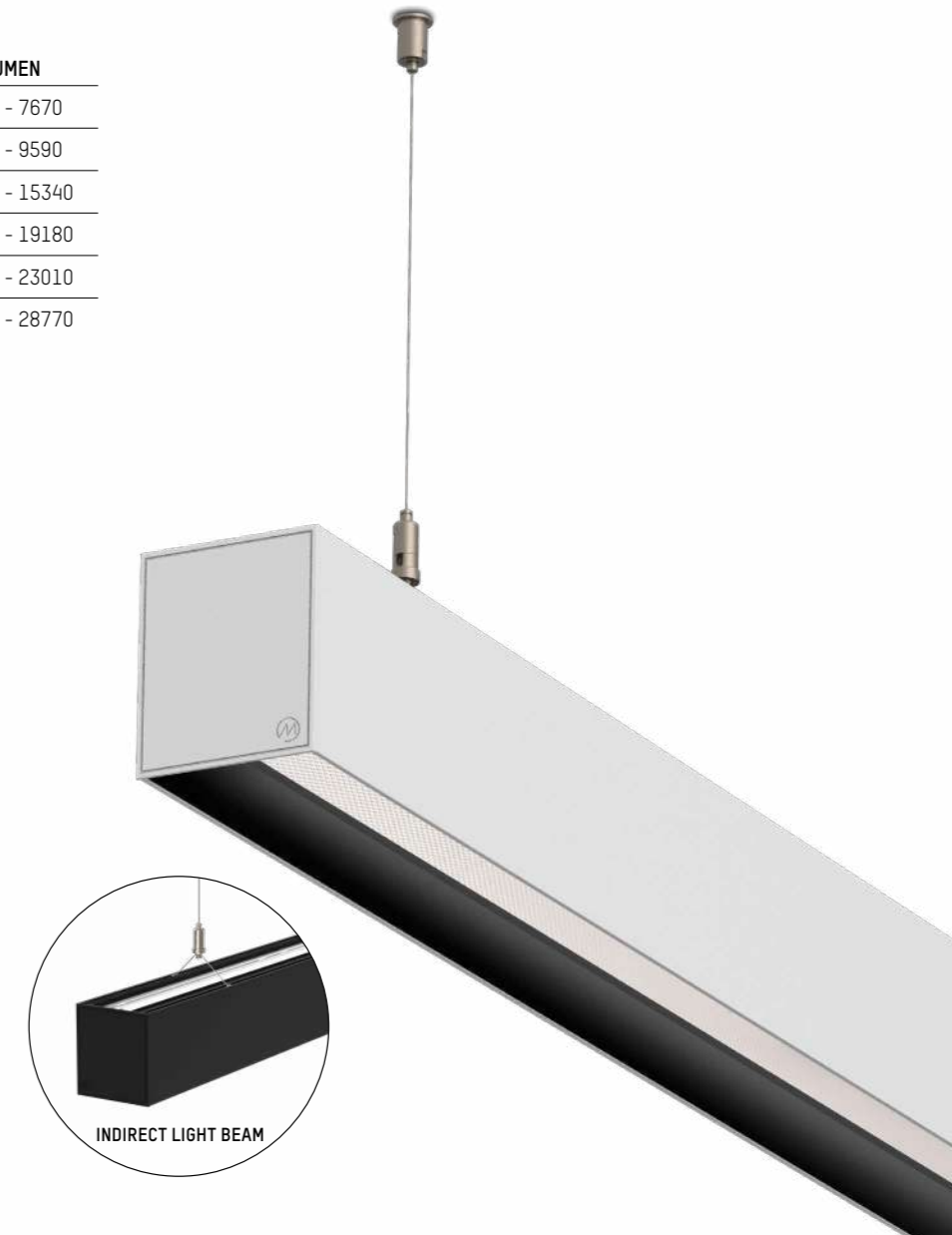
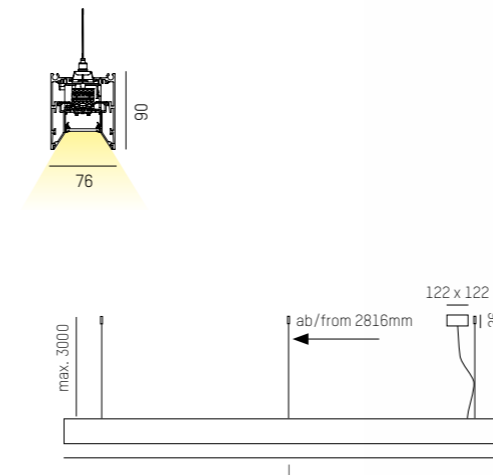

COMPLETE CODE		
WW = LIGHT COLOUR	XX = COLOUR	Y = DIMMABLE
W2 LED 2700K = 13 CRI>80	W white = 56	S switchable = 0
W3 LED 3000K = 19 CRI>80	S black = 66	D DALI dim = d
W4 LED 4000K = 14 CRI>80	AE alu anodized = 86	

LOG OUT 2.1 SD

LOG OUT 2.1 SD OPAL / MICROPRISMA IP20 Ⓢ CE
 220-240V AC 50/60Hz Design: INHOUSE

LED Aufbauleuchte aus Aluminiumprofil · Oberfläche pulverbeschichtet oder eloxiert · Abdeckung mit Mikroprismenoptik oder Opaldiffusor
 LED surface luminaire from aluminium profile · surface powder-coated or anodized · opal or microprismatic diffuser
 Lampada LED a plafone con profilo in alluminio · superficie verniciata a polveri o anodizzata · diffusore opale o microprismatico
 Plafonnier LED en profilé d'aluminium · surface lacquée en poudre ou anodisée · diffuseur opal ou en microprisme

CODE	SYS W	L mm	LUMEN
728-10103LCWWXXY	12 / 24	850	1490 - 2950
728-10104LCWWXXY	16 / 31	1131	1940 - 3930
728-10105LCWWXXY	20 / 40	1411	2430 - 4920
728-10106LCWWXXY	32 / 62	2255	3880 - 7860
728-10107LCWWXXY	40 / 80	2816	4860 - 9840
728-10108LCWWXXY	48 / 93	3379	5820 - 11790
728-10109LCWWXXY	60 / 120	4220	7290 - 14760

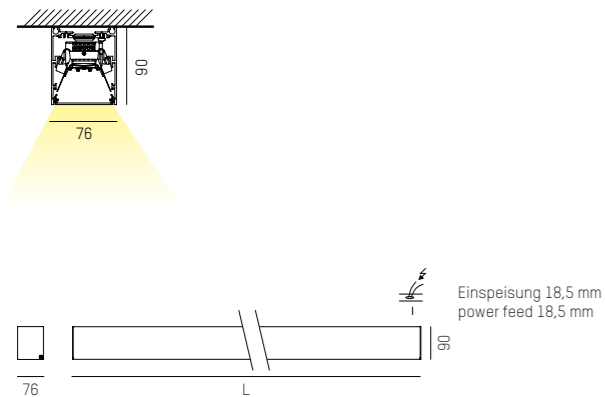

COMPLETE CODE				
L = LIGHT INSERT	C = COVER	WW = LIGHT COLOUR	XX = COLOUR	Y = DIMMABLE
MO MID OUTPUT = 1	Opal = 1	W2 LED 2700K = 13 CRI>80	W white = 50	S switchable = 0
HO HIGH OUTPUT = 3	microprismatic foil = 8 UGR<19 (only MID OUTPUT)	W3 LED 3000K = 19 CRI>80	S black = 60	D DALI dim = d
		W4 LED 4000K = 14 CRI>80	AE alu anodized = 80	

LOG 2.1 OUT BINA LENS SD IP20 Ⓢ CE
 220-240V AC 50/60Hz Design: INHOUSE UGR<19

LED Aufbauleuchte aus Aluminiumprofil · Oberfläche pulverbeschichtet oder eloxiert · schwarzer Lichteinsatz mit Linseneinsatz
 LED surface luminaire from aluminium profile · surface powder-coated or anodized · black light insert with lens insert
 Lampada LED a plafone con profilo in alluminio · superficie verniciata a polveri o anodizzata · inserto a luce nera con lente
 Plafonnier LED en profilé d'aluminium · surface lacquée en poudre ou anodisée · insert de lumière noire avec lentille

CODE	SYS W	L mm	LUMEN
728-1070436WWXXY	43	1131	4370 - 4650
728-1070636WWXXY	86	2255	8740 - 9300
728-1070836WWXXY	129	3379	13110 - 13950

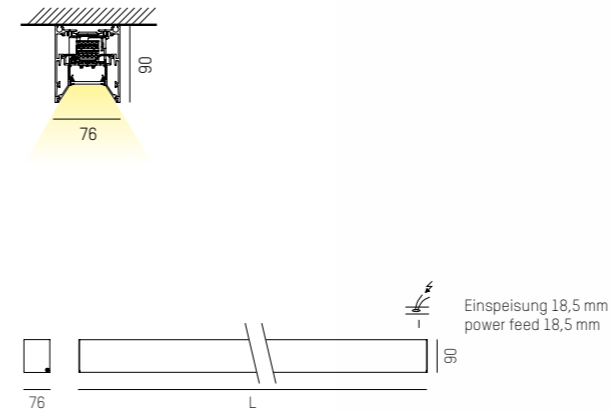

COMPLETE CODE		
WW = LIGHT COLOUR	XX = COLOUR	Y = DIMMABLE
W2 LED 2700K = 13 CRI>80	W white = 56	S switchable = 0
W3 LED 3000K = 19 CRI>80	S black = 66	D DALI dim = d
W4 LED 4000K = 14 CRI>80	AE alu anodized = 86	

LOG OUT 2.1 SD

LOG OUT 2.1 BINA SD

220-240V AC 50/60Hz Design: INHOUSE

IP20 CE

LED Aufbauleuchte aus Aluminiumprofil · Oberfläche pulverbeschichtet oder eloxiert · Lichteinsätze schwarz oder weiß mit Opaldiffusor
 LED surface luminaire from aluminium profile · surface powder-coated or anodized · light inserts black or white with opal diffuser
 Lampada LED a plafone con profilo in alluminio · superficie verniciata a polveri o anodizzata · inserti luminosi neri o bianchi con diffusore opale
 Plafonnier LED en profilé d'aluminium · surface lacquée en poudre ou anodisée · inserts lumineux noirs ou blancs avec diffuseur opal

CODE	SYS W	L mm	LUMEN
728-10203L1WWXXY	12 / 24	850	1130 - 3090
728-10204L1WWXXY	16 / 31	1131	1510 - 4120
728-10205L1WWXXY	20 / 40	1411	1890 - 5150
728-10206L1WWXXY	32 / 62	2255	3020 - 8240
728-10207L1WWXXY	40 / 80	2816	3780 - 10300
728-10208L1WWXXY	48 / 93	3379	4530 - 12360
728-10209L1WWXXY	60 / 120	4220	5670 - 15450

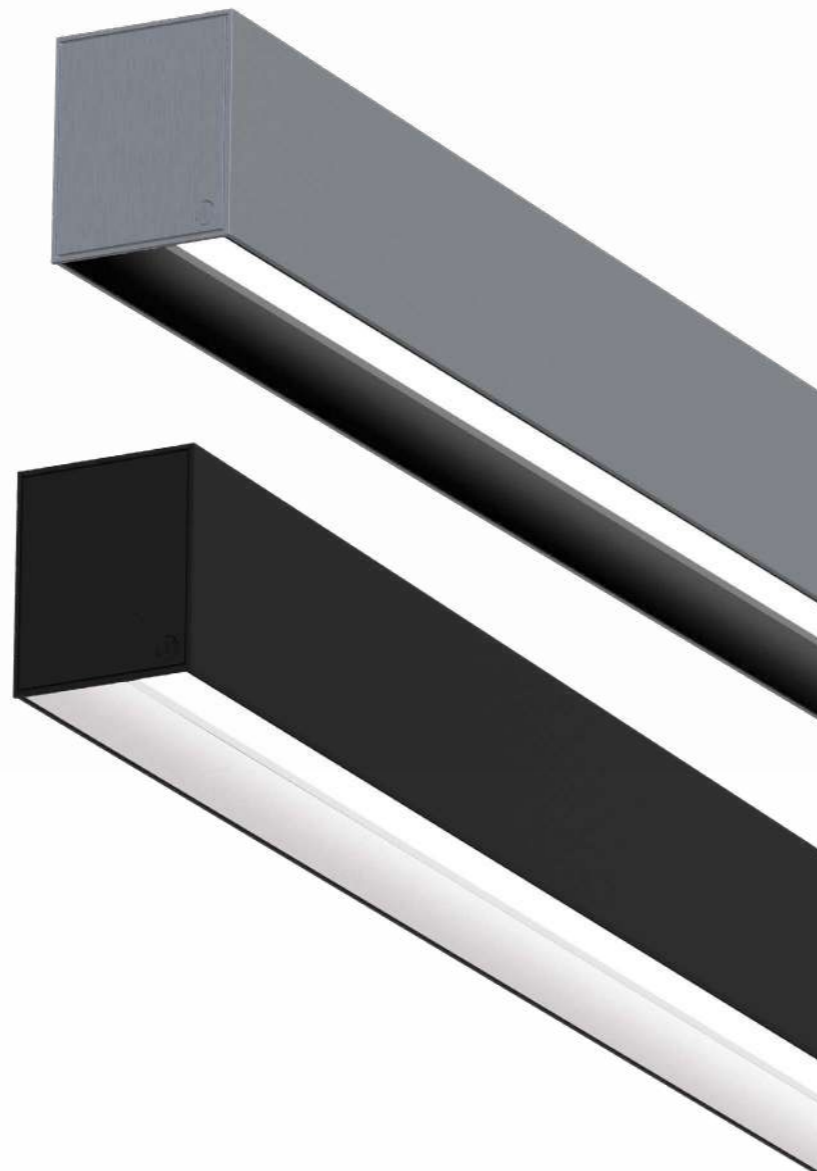
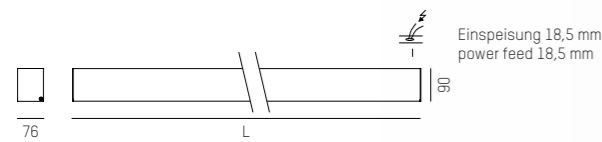
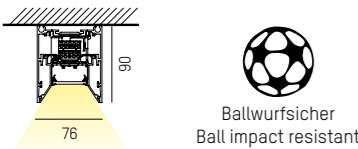

COMPLETE CODE				
L = LIGHT INSERT	WW = LIGHT COLOUR	X = COLOUR PROFILE	X = COLOUR LIGHT INSERT	Y = DIMMABLE
M2 MID OUTPUT = 1	W2 LED 2700K = 13 CRI>80	W white = 5	W white = 5	S switchable = 0
H2 HIGH OUTPUT = 3	W3 LED 3000K = 19 CRI>80	S black = 6	S black = 6	D DALI dim = d
	W4 LED 4000K = 14 CRI>80	AE alu anodized = 8		

LOG OUT 2.1 BINA OFFICE SD

220-240V AC 50/60Hz Design: INHOUSE UGR<19

IP20 CE

LED Aufbauleuchte aus Aluminiumprofil · Oberfläche pulverbeschichtet oder eloxiert · schwarzer Lichteinsatz mit Mikroprismenoptik
 LED surface luminaire from aluminium profile · surface powder-coated or anodized · black light insert with microprismatic diffuser
 Lampada LED a plafone con profilo in alluminio · superficie verniciata a polveri o anodizzata · inserto a luce nera con ottica a microprismi
 Plafonnier LED en profilé d'aluminium · surface lacquée en poudre ou anodisée · insert de lumière noire avec optique à microprisme

CODE	SYS W	L mm	LUMEN
728-1020332WWXXY	26	850	2060 - 2220
728-1020432WWXXY	34	1131	2750 - 2960
728-1020532WWXXY	41	1411	3440 - 3700
728-1020632WWXXY	68	2255	5500 - 5920
728-1020732WWXXY	82	2816	6880 - 7400
728-1020832WWXXY	102	3379	8250 - 8880
728-1020932WWXXY	123	4220	10320 - 11100

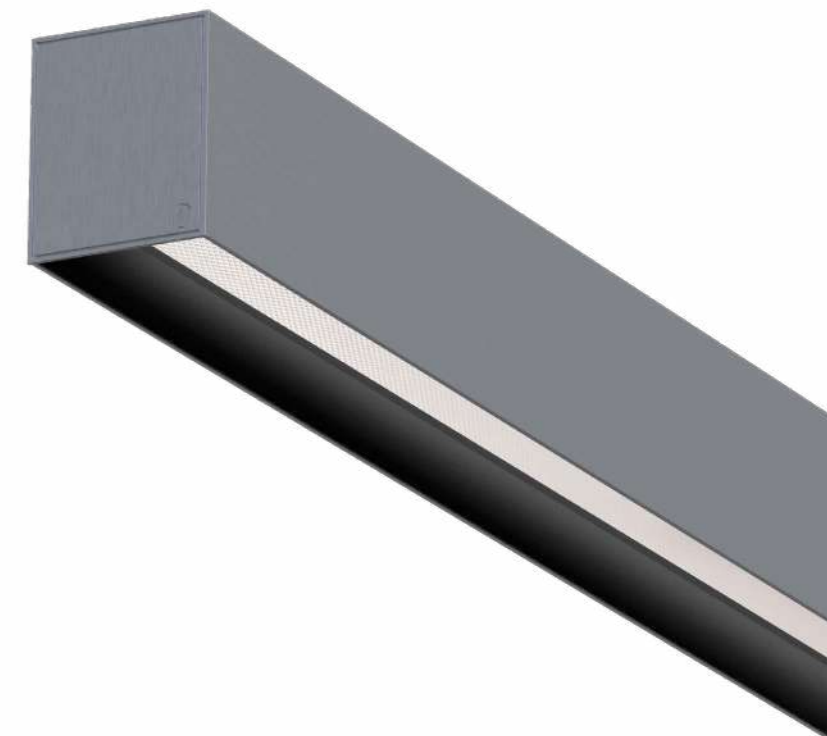
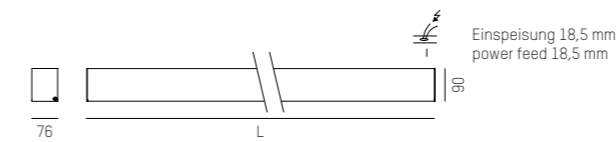
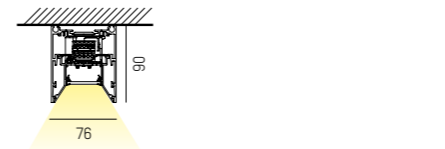

COMPLETE CODE		
WW = LIGHT COLOUR	XX = COLOUR	Y = DIMMABLE
W2 LED 2700K = 13 CRI>80	W white = 56	S switchable = 0
W3 LED 3000K = 19 CRI>80	S black = 66	D DALI dim = d
W4 LED 4000K = 14 CRI>80	AE alu anodized = 86	

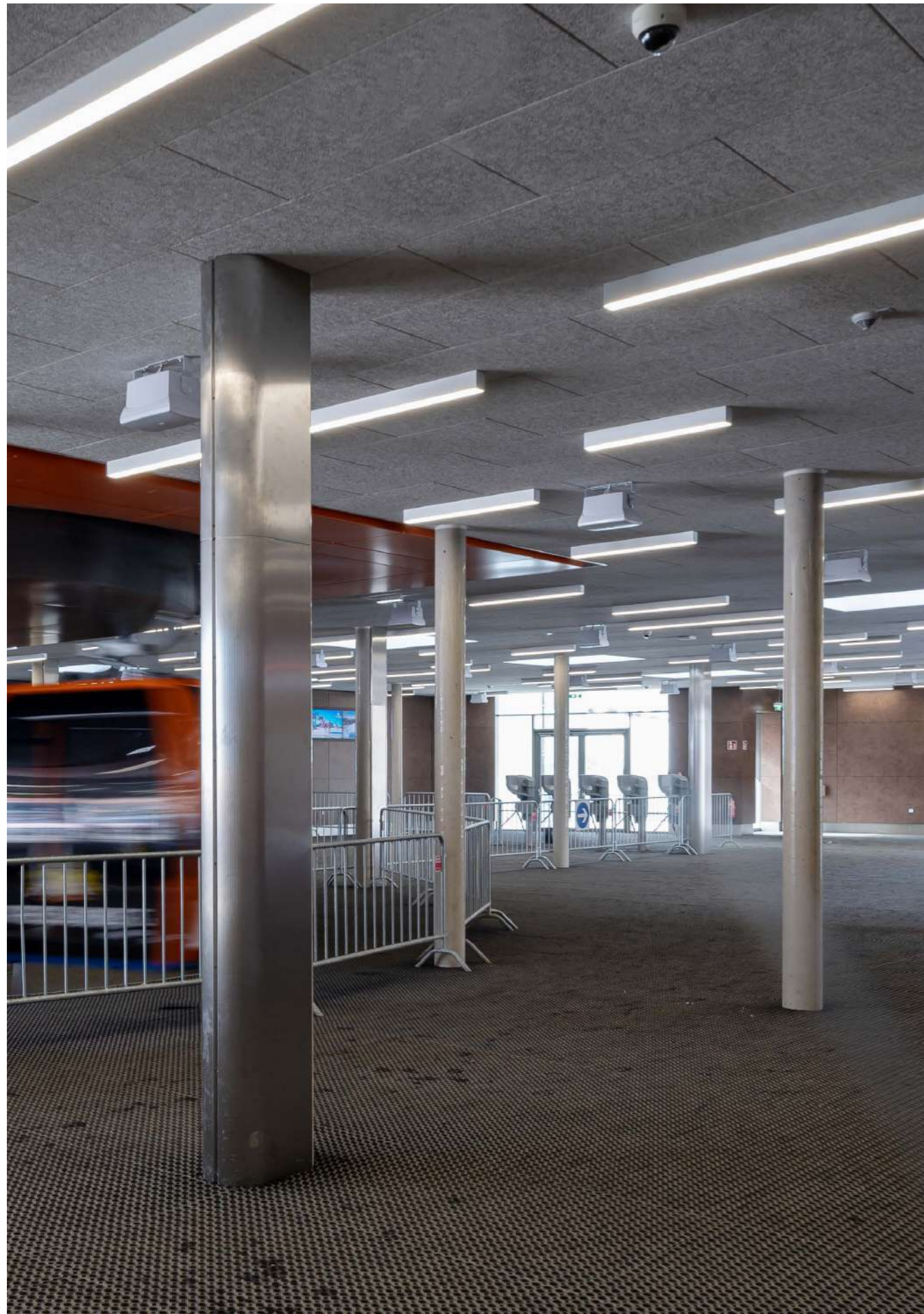

Kreischbergbahn, Murau, Austria, Photo: Joachim Rauch

LOG OUT 2.1 IP54 SD

IP54

LOG OUT 2.1 IP54 SD

220-240V AC 50/60Hz Design: INHOUSE

LED Aufbauleuchte aus Aluminiumprofil · Oberfläche pulverbeschichtet oder eloxiert · Abdeckung mit Opaldiffusor · IP54
 LED surface luminaire from aluminium profile · surface powder-coated or anodized · opal diffuser · IP54
 Lampada LED a plafone con profilo in alluminio · superficie verniciata a polveri o anodizzata · diffusore opale · IP54
 Plafonnier LED en profilé d'aluminium · surface lacquée en poudre ou anodisée · diffuseur opal · IP54

CODE	SYS W	L mm	LUMEN
728-10403LCWWXXY	12 / 24	870	1490 - 2950
728-10404LCWWXXY	16 / 31	1151	1980 - 3930
728-10405LCWWXXY	20 / 40	1431	2480 - 4920
728-10406LCWWXXY	32 / 62	2275	3960 - 7860
728-10407LCWWXXY	40 / 80	2836	4960 - 9840
728-10408LCWWXXY	48 / 93	3399	5940 - 11790
728-10409LCWWXXY	60 / 120	4240	7440 - 14760

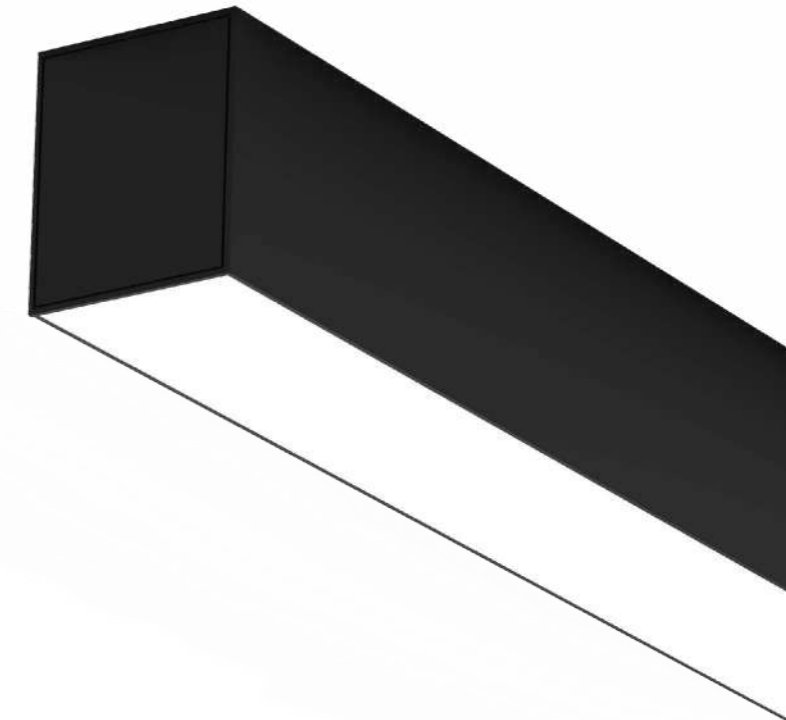
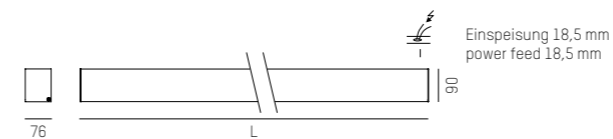
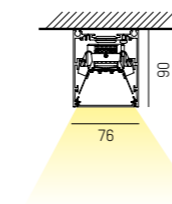

COMPLETE CODE				
L = LIGHT INSERT	C = COVER	WW = LIGHT COLOUR	XX = COLOUR	Y = DIMMABLE
MID OUTPUT = 1	opal = 1	LED 2700K = 13 CRI>80	white = 50	switchable = 0
HIGH OUTPUT = 3		LED 3000K = 19 CRI>80	black = 60	DALI dim = d
		LED 4000K = 14 CRI>80	alu anodized = 80	

LOG IN 2.1 R









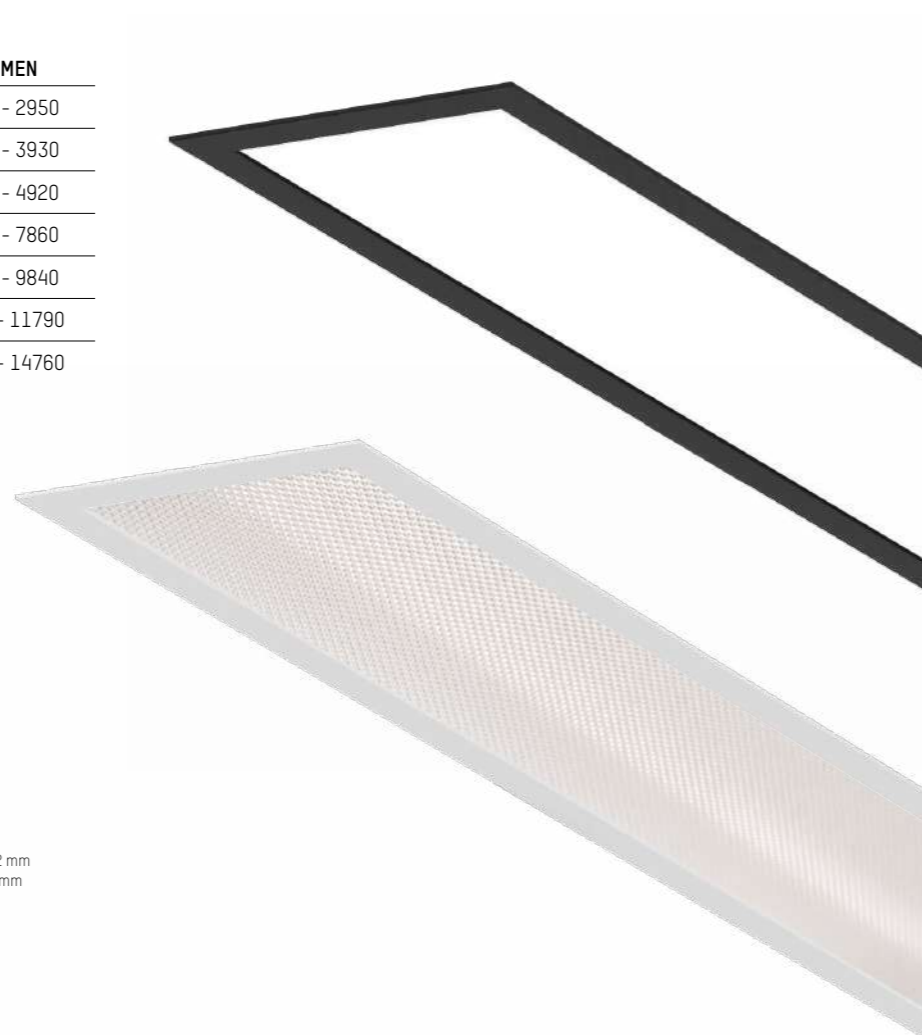
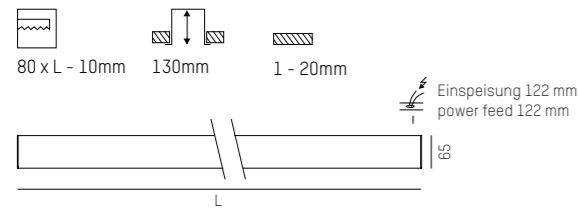
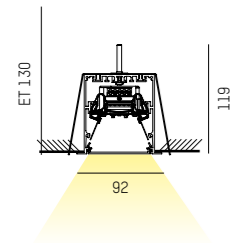



LOG IN 2.1 R OPAL / MICROPRISMA IP20 

220-240V AC 50/60Hz Design: INHOUSE

LED Einbauleuchte aus Aluminiumprofil · Oberfläche pulverbeschichtet oder eloxiert · Abdeckung mit Mikroprismenoptik oder Opaldiffusor
 LED recessed luminaire from aluminium profile · surface powder-coated or anodized · opal or microprismatic diffuser
 Lampada ad incasso con profilo in alluminio · superficie verniciata a polveri o anodizzata · diffusore opale o microprismatico
 Luminaire encastré en profilé d'aluminium · surface lacquée en poudre ou anodisée · diffuseur opal ou en microprisme

CODE	SYS W	L mm	LUMEN
728-30103LCWWXXY	12 / 24	886	1450 - 2950
728-30104LCWWXXY	16 / 31	1147	1940 - 3930
728-30105LCWWXXY	20 / 40	1427	2430 - 4920
728-30106LCWWXXY	32 / 62	2271	3880 - 7860
728-30107LCWWXXY	40 / 80	2832	4860 - 9840
728-30108LCWWXXY	48 / 93	3395	5820 - 11790
728-30109LCWWXXY	60 / 120	4236	7290 - 14760



COMPLETE CODE				
L = LIGHT INSERT	C = COVER	WW = LIGHT COLOUR	XX = COLOUR	Y = DIMMABLE
 MID OUTPUT = 1	 opal = 1	 LED 2700K = 13 CRI>80	 white = 50	 switchable = 0
 HIGH OUTPUT = 3	 microprismatic foil = 8	 LED 3000K = 19 CRI>80	 black = 60	 DALI dim = d
	UGR<19 (only MID OUTPUT)	 LED 4000K = 14 CRI>80	 alu anodized = 80	







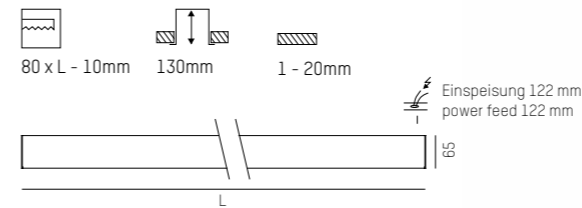
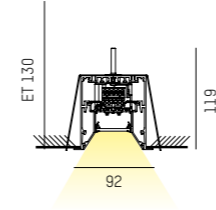

LOG 2.1 IN BINA LENS R IP20 

220-240V AC 50/60Hz Design: INHOUSE UGR<19

LED Einbauleuchte aus Aluminiumprofil · Oberfläche pulverbeschichtet oder eloxiert · schwarzer Lichteinsatz mit Linseneinsatz
 LED recessed luminaire from aluminium profile · surface powder-coated or anodized · black light insert with lens insert
 Lampada ad incasso con profilo in alluminio · superficie verniciata a polveri o anodizzata · inserto a luce nera con lente
 Luminaire encastré en profilé d'aluminium · surface lacquée en poudre ou anodisée · insert de lumière noire avec lentille

CODE	SYS W	L mm	LUMEN
728-3070436WWXXY	43	1147	4370 - 4650
728-3070636WWXXY	86	2271	8740 - 9300
728-3070836WWXXY	129	3395	13110 - 13950



COMPLETE CODE		
WW = LIGHT COLOUR	XX = COLOUR	Y = DIMMABLE
 LED 2700K = 13 CRI>80	 white = 56	 switchable = 0
 LED 3000K = 19 CRI>80	 black = 66	 DALI dim = d
 LED 4000K = 14 CRI>80	 alu anodized = 86	

LOG IN 2.1 R

LOG IN 2.1 BINA R

220-240V AC 50/60Hz Design: INHOUSE

IP20

LED Einbauleuchte aus Aluminiumprofil · Oberfläche pulverbeschichtet oder eloxiert · Lichteinsätze schwarz oder weiß mit Opaldiffusor
 LED recessed luminaire from aluminium profile · surface powder-coated or anodized · light inserts black or white with opal diffuser
 Lampada ad incasso con profilo in alluminio · superficie verniciata a polveri o anodizzata · inserti luminosi neri o bianchi con diffusore opale
 Luminaire encastré en profilé d'aluminium · surface lacquée en poudre ou anodisée · inserts lumineux noirs ou blancs avec diffuseur opal

CODE	SYS W	L mm	LUMEN
728-30203L1 WWXXY	12 / 24	886	1130 - 3090
728-30204L1 WWXXY	16 / 31	1147	1510 - 4120
728-30205L1 WWXXY	20 / 40	1427	1890 - 5150
728-30206L1 WWXXY	32 / 62	2271	3020 - 8240
728-30207L1 WWXXY	40 / 80	2832	3780 - 10300
728-30208L1 WWXXY	48 / 93	3395	4530 - 12360
728-30209L1 WWXXY	60 / 120	4236	5670 - 15450

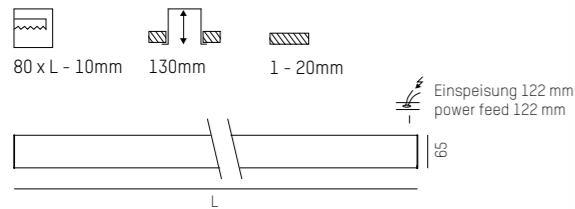
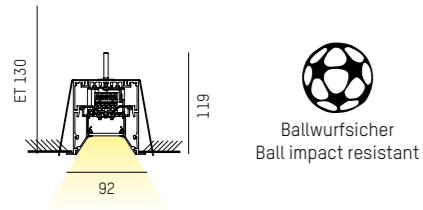

COMPLETE CODE				
L = LIGHT INSERT	WW = LIGHT COLOUR	X = COLOUR PROFILE	X = COLOUR LIGHT INSERT	Y = DIMMABLE
MID OUTPUT = 1	LED 2700K = 13 CRI>80	white = 5	white = 5	switchable = 0
HIGH OUTPUT = 3	LED 3000K = 19 CRI>80	black = 6	black = 6	DALI dim = d
	LED 4000K = 14 CRI>80	alu anodized = 8		

PRODUCTS

LOG IN 2.1 BINA OFFICE R

220-240V AC 50/60Hz Design: INHOUSE UGR<19

IP20

LED Einbauleuchte aus Aluminiumprofil · Oberfläche pulverbeschichtet oder eloxiert · schwarzer Lichteinsatz mit Mikroprismenoptik
 LED recessed luminaire from aluminium profile · surface powder-coated or anodized · black light insert with microprismatic diffuser
 Lampada ad incasso con profilo in alluminio · superficie verniciata a polveri o anodizzata · inserto a luce nera con ottica a microprismi
 Luminaire encastré en profilé d'aluminium · surface lacquée en poudre ou anodisée · insert de lumière noire avec optique à microprisme

CODE	SYS W	L mm	LUMEN
728-3020332 WWXXY	26	850	2060 - 2220
728-3020432 WWXXY	34	1131	2750 - 2960
728-3020532 WWXXY	41	1411	3440 - 3700
728-3020632 WWXXY	68	2255	5500 - 5920
728-3020732 WWXXY	82	2816	6880 - 7400
728-3020832 WWXXY	102	3379	8250 - 8880
728-3020932 WWXXY	123	4220	10320 - 11100

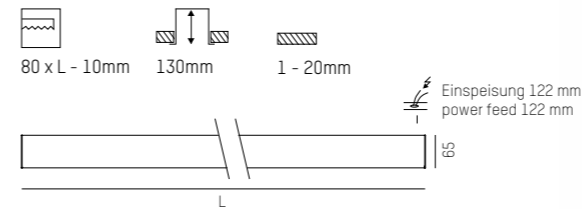
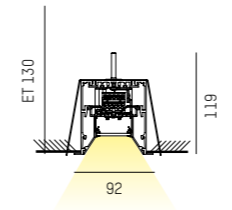

COMPLETE CODE		
WW = LIGHT COLOUR	XX = COLOUR	Y = DIMMABLE
LED 2700K = 13 CRI>80	white = 56	switchable = 0
LED 3000K = 19 CRI>80	black = 66	DALI dim = d
LED 4000K = 14 CRI>80	alu anodized = 86	

PRODUCTS



Raiffeisenbank, Steyr, Austria, Design + Architektur AREA.at, Photo: Joachim Rauch

LOG IN 2.1 IP54 R

LOG IN 2.1 IP54 R

220-240V AC

50/60Hz

Design: INHOUSE

IP54

LED Einbauleuchte aus Aluminiumprofil · Oberfläche pulverbeschichtet oder eloxiert · Abdeckung mit Opaldiffusor · IP54
 LED recessed luminaire from aluminium profile · surface powder-coated or anodized · opal diffuser · IP54
 Lampada ad incasso con profilo in alluminio · superficie verniciata a polveri o anodizzata · diffusore opale · IP54
 Luminaire encastré en profilé d'aluminium · surface lacquée en poudre ou anodisée · diffuseur opal · IP54

CODE	SYS W	L mm	LUMEN
728-30403LCWWXXY	12 / 24	886	1490 - 2950
728-30404LCWWXXY	16 / 31	1167	1980 - 3930
728-30405LCWWXXY	20 / 40	1447	2480 - 4920
728-30406LCWWXXY	32 / 62	2291	3960 - 7860
728-30407LCWWXXY	40 / 80	2852	4960 - 9840
728-30408LCWWXXY	48 / 93	3415	5940 - 11790
728-30409LCWWXXY	60 / 120	4256	7440 - 14760

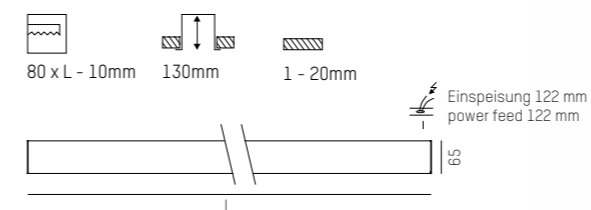
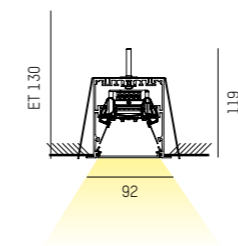

COMPLETE CODE

L = LIGHT INSERT	C = COVER	WW = LIGHT COLOUR	XX = COLOUR	Y = DIMMABLE
MID OUTPUT = 1	opal = 1	LED 2700K = 13 CRI>80	white = 50	switchable = 0
HIGH OUTPUT = 3		LED 3000K = 19 CRI>80	black = 60	DALI dim = d
		LED 4000K = 14 CRI>80	alu anodized = 80	



Les Deux, Copenhagen, Denmark, Photo: onthespot

LOG OUT 2.1 TRACK

LOG OUT 2.1 TRACK

IP20

220-240V AC 50/60Hz Design: INHOUSE

LED Schienenleuchte aus Aluminiumprofil · Oberfläche pulverbeschichtet oder eloxiert · mit Opal oder Mikroprismendiffusor erhältlich
 LED track luminaire from aluminium profile · surface powder-coated or anodized · available with opal or microprismatic diffusor
 Proiettore da binario in alluminio · superficie verniciata a polveri o anodizzata · diffusore opale o microprismatico
 Spot pour rail en profilé d'aluminium · surface lacquée en poudre ou anodisée · diffuseur opal ou microprismatique

CODE	SYS W	L mm	LUMEN
728-50104LCWWXXY	16 / 31	1131	1940 - 3930
728-50105LCWWXXY	20 / 40	1411	2430 - 4920

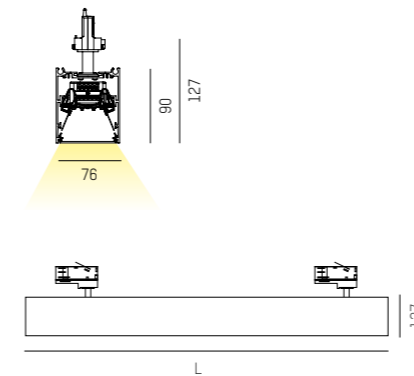

COMPLETE CODE

L = LIGHT INSERT	C = COVER	WW = LIGHT COLOUR	XX = COLOUR	Y = DIMMABLE
MID OUTPUT = 1	opal = 1	LED 2700K = 13 CRI>80	white = 50	switchable = 0
HIGH OUTPUT = 3	microprismatic foil = 8	LED 3000K = 19 CRI>80	black = 60	PULSE DALI dim = p
	UGR<19 [only MID OUTPUT]	LED 4000K = 14 CRI>80	alu anodized = 80	



LOG 2.1 SYSTEM

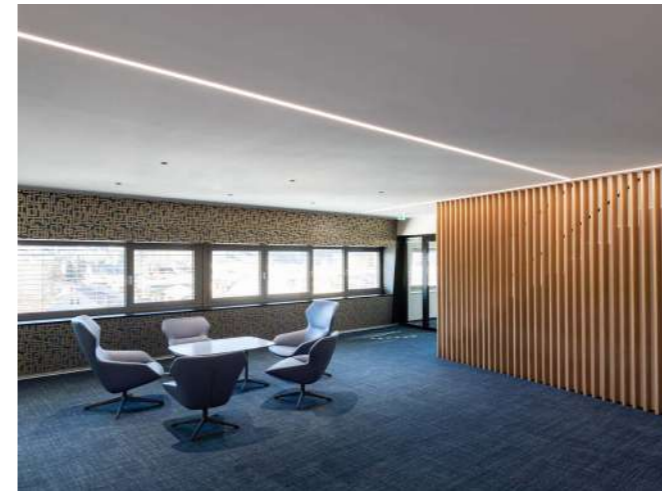

IBS Austria GmbH, Teufenbach, Austria, Photo: Joachim Rauch



Hotel Aigo, Aigen, Austria, Photo: Joachim Rauch



Mehler & Hamberger, Traunstein, Germany, Photo: Joachim Rauch



Tischlerei Berger, Ratten, Austria, Photo: Joachim Rauch



Originalphoto by W+K-Fotografie Wels | www.wkphoto.net



Project: Adidas Headquarter | Lisboa | Portugal | Photo: Aura Light

LOG 2.1 SYSTEM

VARIATIONS

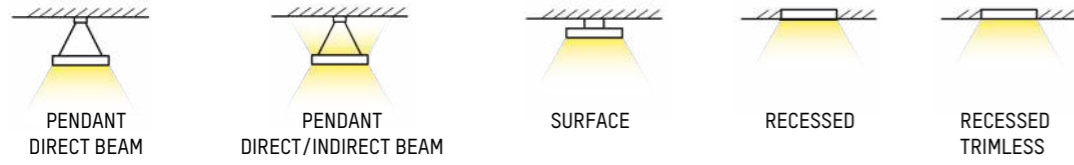

PROFILE

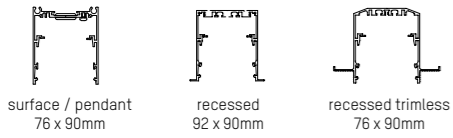

FORM



LED COLOURS



CORE COLOURS



INSERTS



COVER OPTIONS



Tischlerei Berger
Ratten, Austria
Photo: Joachim Rauch



Mehler & Hamberger, Traunstein, Germany, Photo: Joachim Rauch

LOG 2.1 SYSTEM CONFIGURATOR

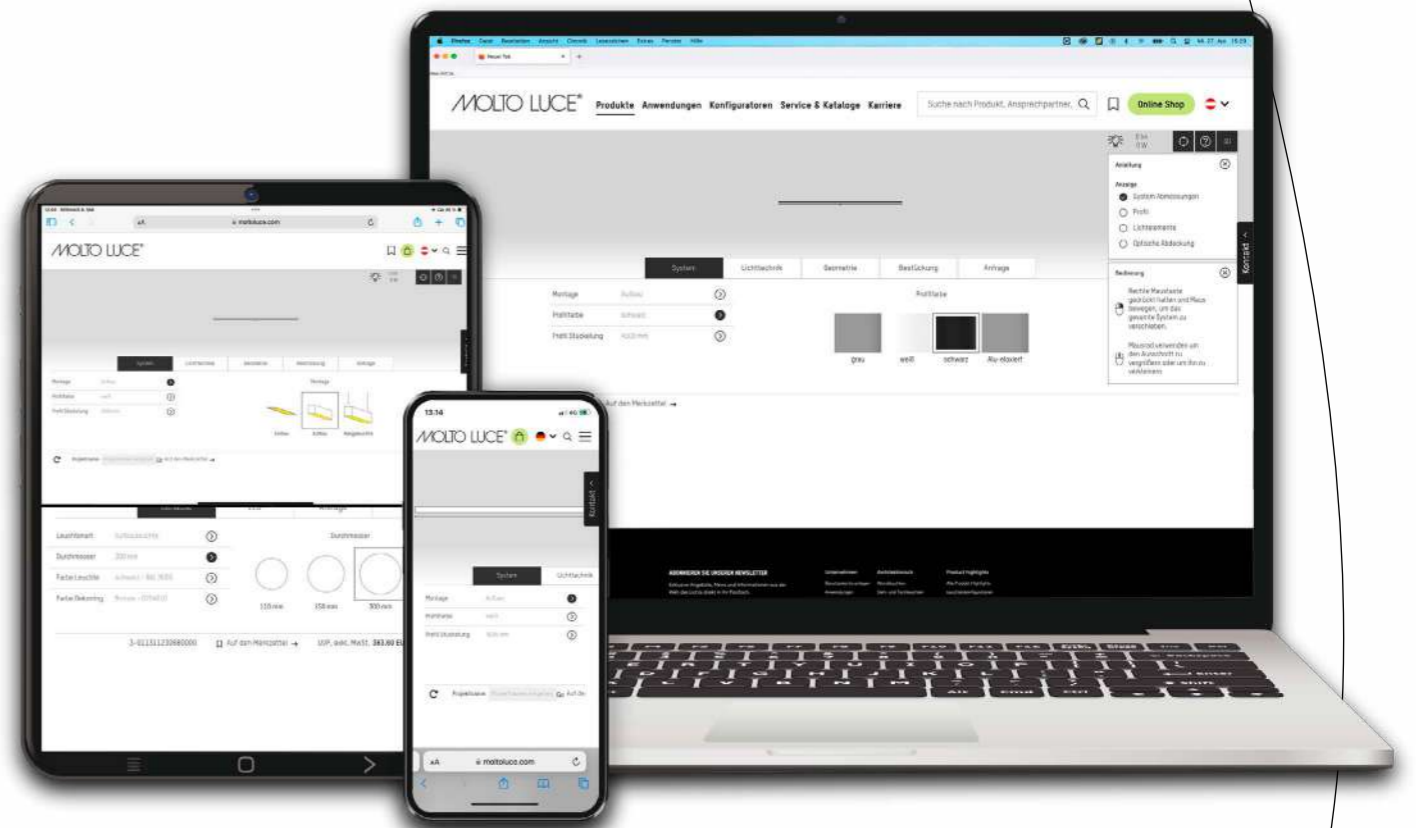
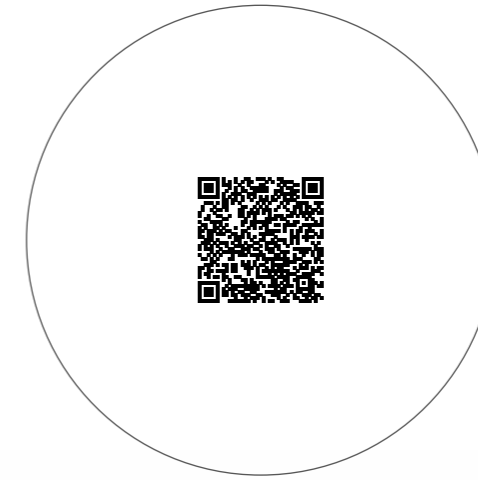

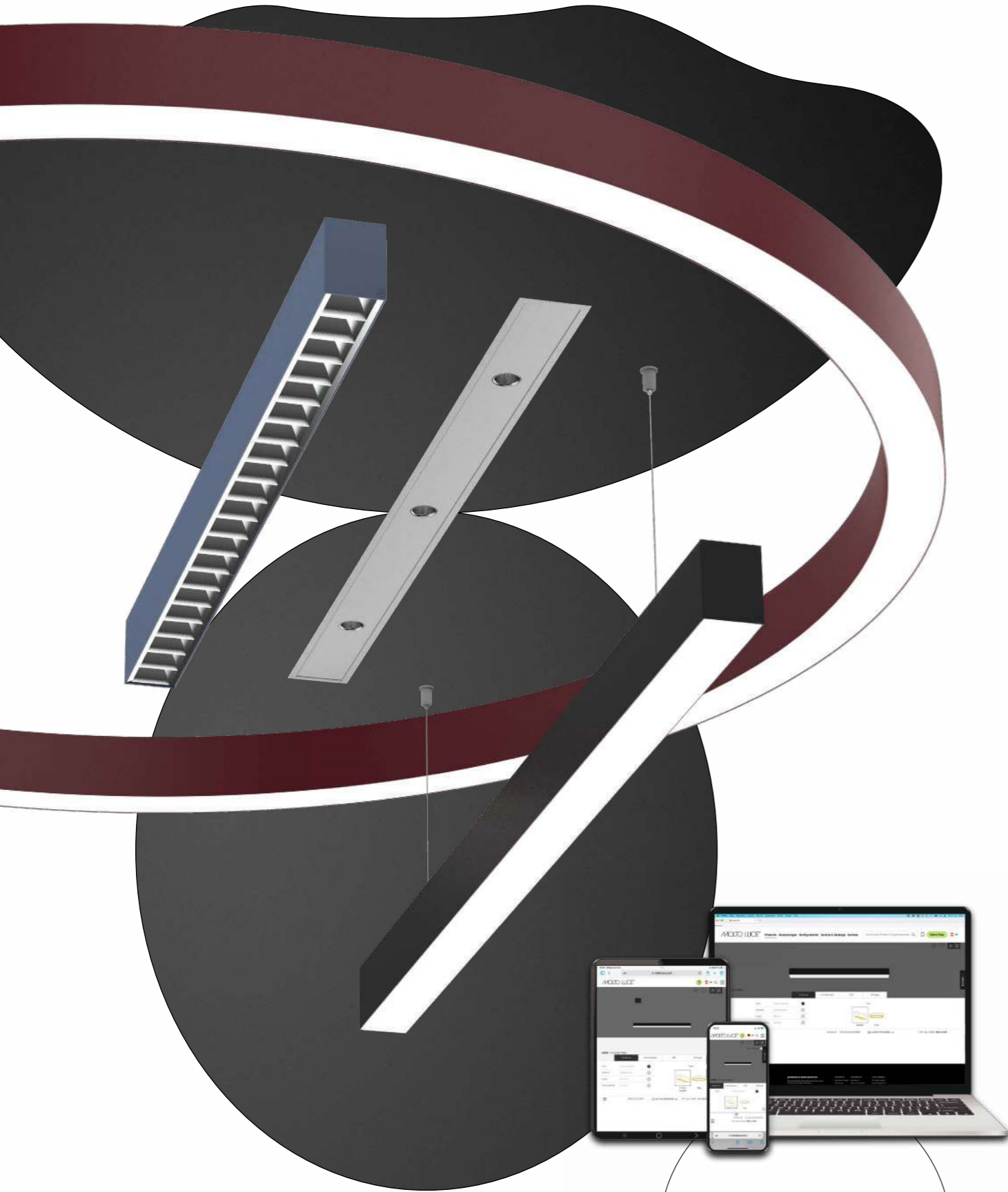

LOG 50

 more information



Dr. Haim, Vomp, Austria, Photo: Joachim Rauch



Work Experience Space , Cologne, Germany, Photo: Project Rheinland AG



Private residence



Hübner, Wels, Austria, Photo: Joachim Rauch



Elements, Gusswerk Salzburg, Austria, Photo: Joachim Rauch



BFI, Linz, Austria, Photo: Joachim Rauch

LOG 50



Dr. Haim, Vomp, Austria, Photo: Joachim Rauch

THE GOLDEN MIDDLE

LOG 50 bietet die perfekte Ergänzung zu den erfolgreichen Produktserien RIDE und LOG 2.1. Die Dimensionierung der Leuchten liegt genau in der Mitte, wodurch alle Vorteile der beiden bestehenden Linearsysteme, wie die einfache Montage und das reduzierte Design, in einer Leuchtenfamilie vereint werden konnten. Lineare und runde Lichtlösungen zählen schon lange zum fixen Bestandteil moderner Architekturkonzepte. LOG 50 kombiniert dabei hohen Designanspruch mit perfekter Lichtleistung.

LOG 50 offers the perfect complement to the successful RIDE and LOG 2.1 product series. The dimensioning of the luminaires is exactly in the middle, which made it possible to combine all the advantages of the two existing linear systems, such as easy mounting and reduced design in one luminaire family. Linear and circle lighting solutions have long been an integral part of modern architectural concepts. LOG 50 combines high design standards with perfect lighting performance.

Design: INHOUSE

VARIATIONS

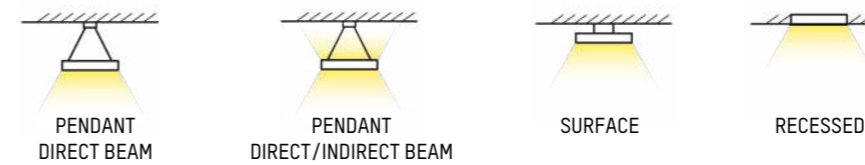

PROFILE

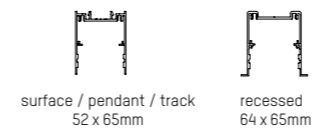

FORM & SIZES

linear	circle
L: 846mm / 800 - 2570lm	Ø 765mm / 3360 - 12020lm
L: 1126mm / 1000 - 3420 lm	Ø 1125mm / 5040 - 18040lm
L: 1407mm / 1250 - 4280lm	Ø 1480mm / 6730 - 24050lm
L: 1687mm / 1600 - 5130lm	Ø 1840mm / 8410 - 30080lm
L: 2248mm / 2000 - 6840lm	Ø 2900mm / 13460 - 48120lm
L: 2529mm / 2400 - 7700lm	
L: 2809mm / 2500 - 8560lm	
L: 3371mm / 3000 - 10260lm	
L: 4212mm / 3750 - 12840lm	

LED COLOURS

W2	W3	W4
2700K	3000K	4000K

CORE COLOURS



CREATIVE COLOURS

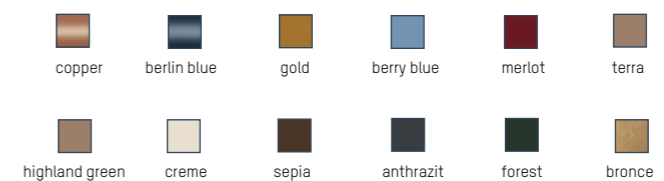

COVER OPTIONS



CREATIVE COLOURS.

-  CREME / CREME
-  TERRA / TERRA
-  BRONZE / BRONZE
-  GOLD / GOLD
-  KUPFER / COPPER
-  MERLOT / MERLOT
-  SEPIA / SEPIA
-  ANTHRACIT / ANTHRACITE
-  BERLINERBLAU / BERLINBLUE
-  BEERENBLAU / BERRYBLUE
-  HOCHLANDGRÜN / HIGHLANDGREEN
-  TANNENGRÜN / FOREST

Ob Beerenblau, Merlot oder Hochlandgrün...unsere Creative Colours harmonieren perfekt mit unserem Produktsortiment und gleichzeitig auch mit den Farben der modernen Architektur. **LOG 50 Leuchten sind in Creative Colours konfigurierbar.**

Be it Berryblue, Merlot or Highlandgreen...our Creative Colours harmonise perfectly with our product range and simultaneously with the colours of modern architecture as well. **LOG 50 luminaires are configurable in Creative Colour.**

COLOURFUL LIGHT.
COLOURFUL LIFE.

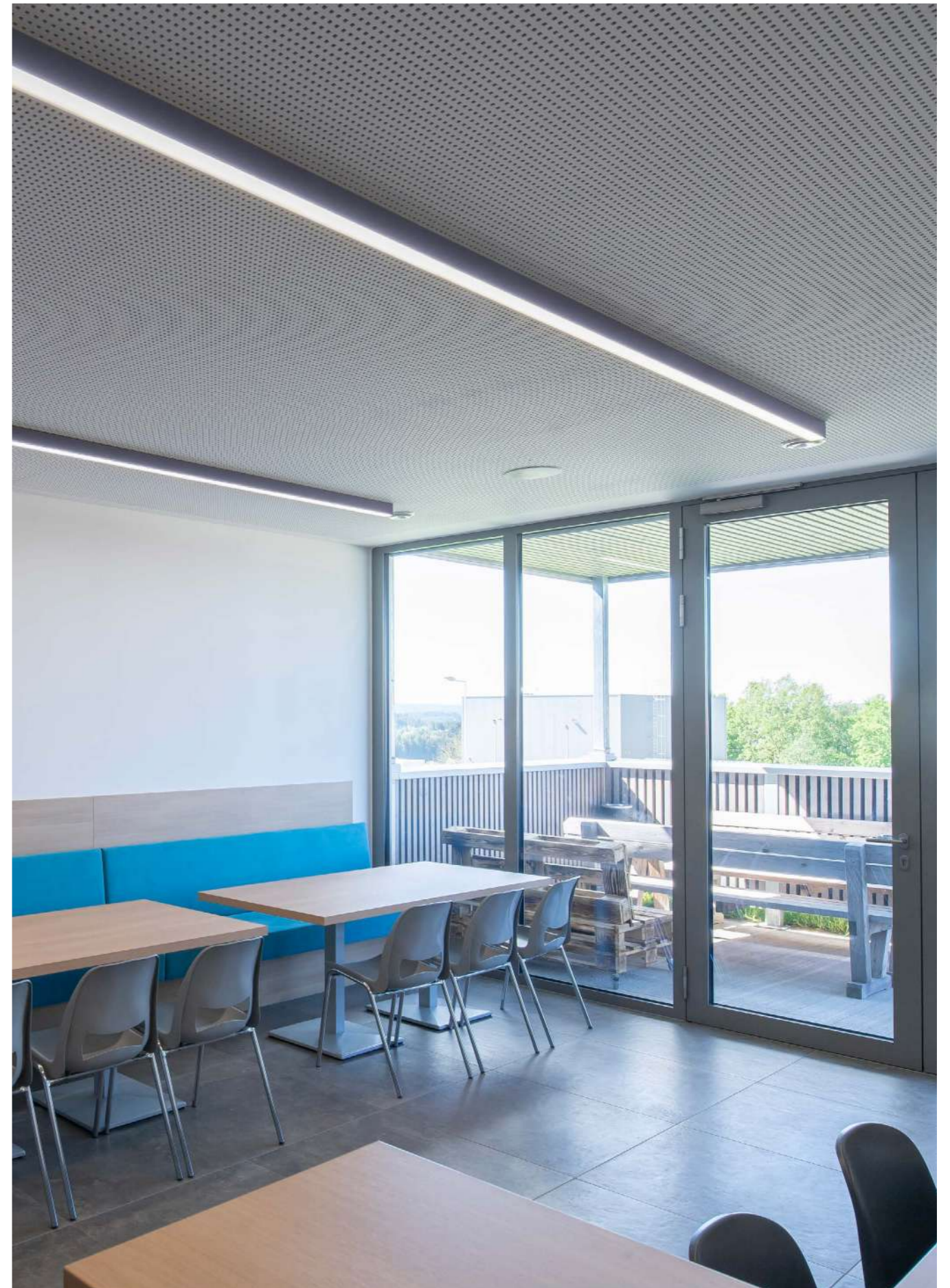

WE Electric, Bad Leonfelden, Austria, Photo: Joachim Rauch



Raiffeisen Arena, Linz, Austria, Photo: Joachim Rauch

LOG 50 CONFIGURATOR

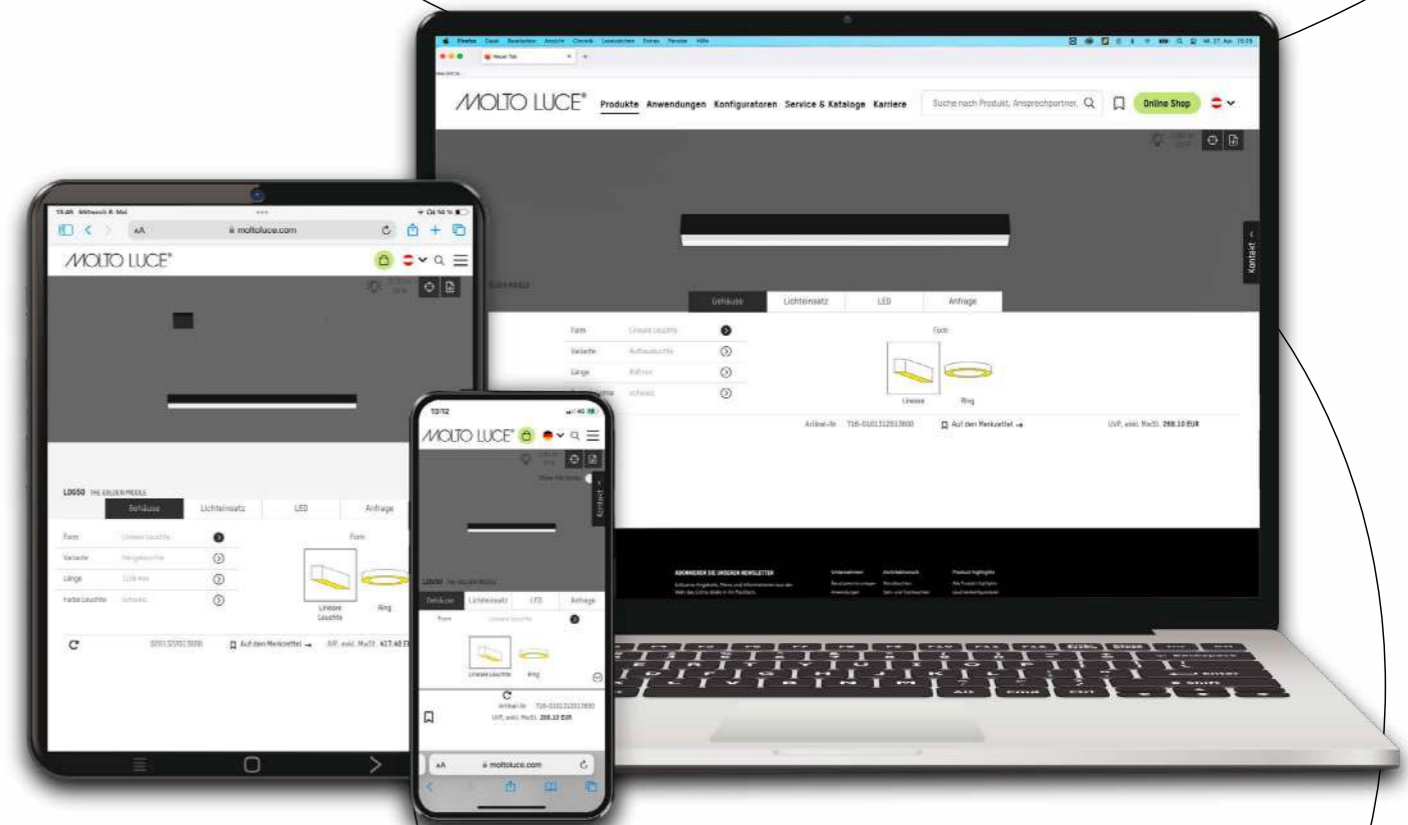

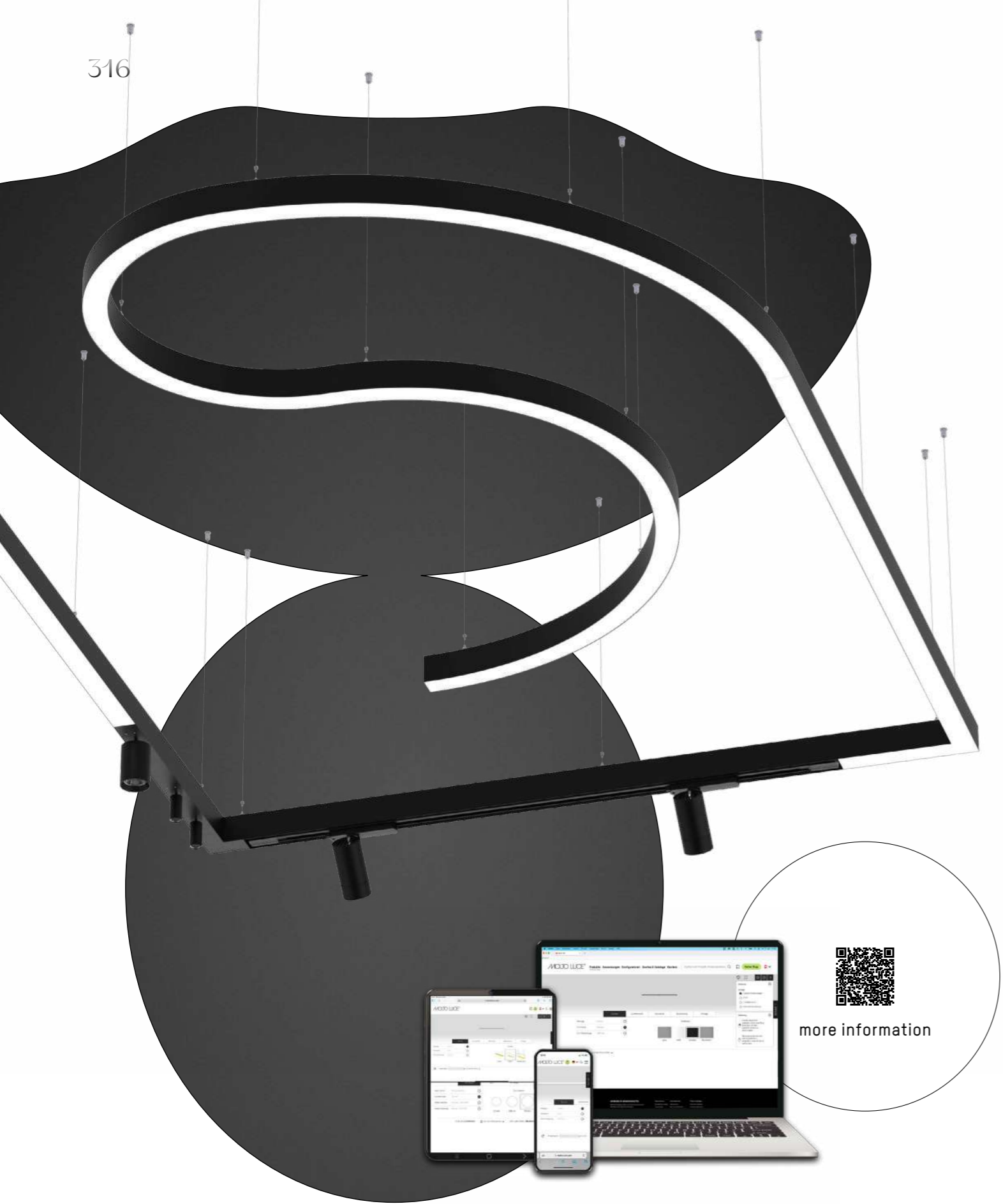

LOG 50 SYSTEM



Dr. Haim, Vomp, Austria, Photo: Joachim Rauch



Town theatre, Bad Hall, Austria, Photo: Joachim Rauch

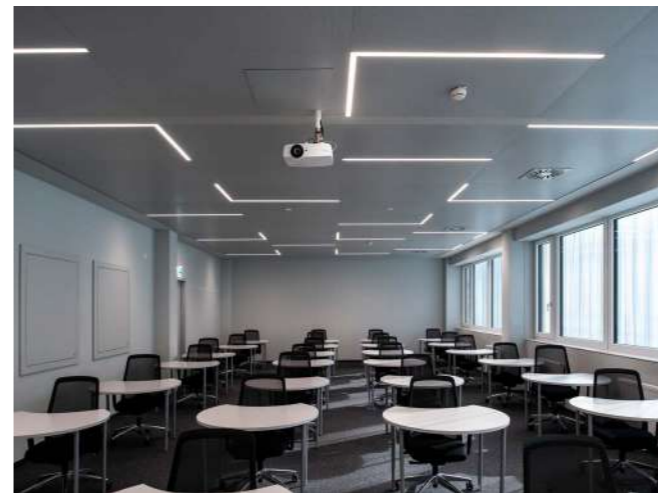

BFI, Linz, Austria, Photo: Joachim Rauch

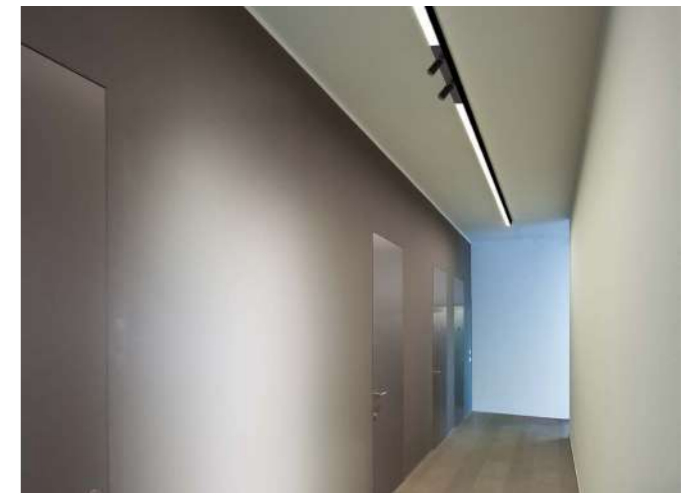

ETM, Haag, Austria, Photo: Joachim Rauch



Molto Luce, Munich, Germany, Photo: Joachim Rauch



Rendering

LOG 50 SYSTEM

VARIATIONS

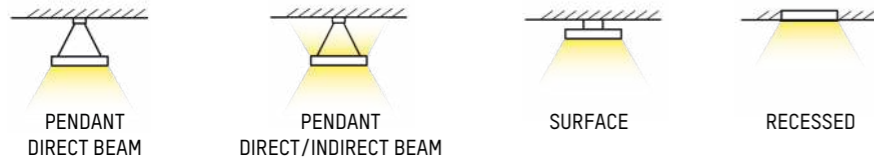

PROFILE

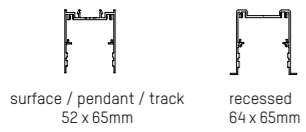

FORM & SIZES



LED COLOURS



CORE COLOURS



CREATIVE COLOURS

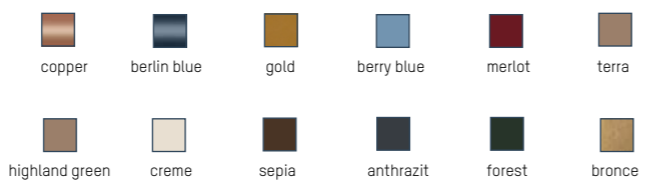

INSERT OPTIONS

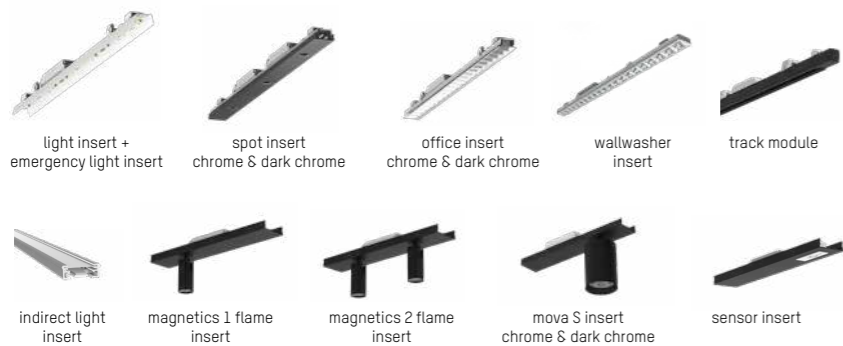

COVER OPTIONS

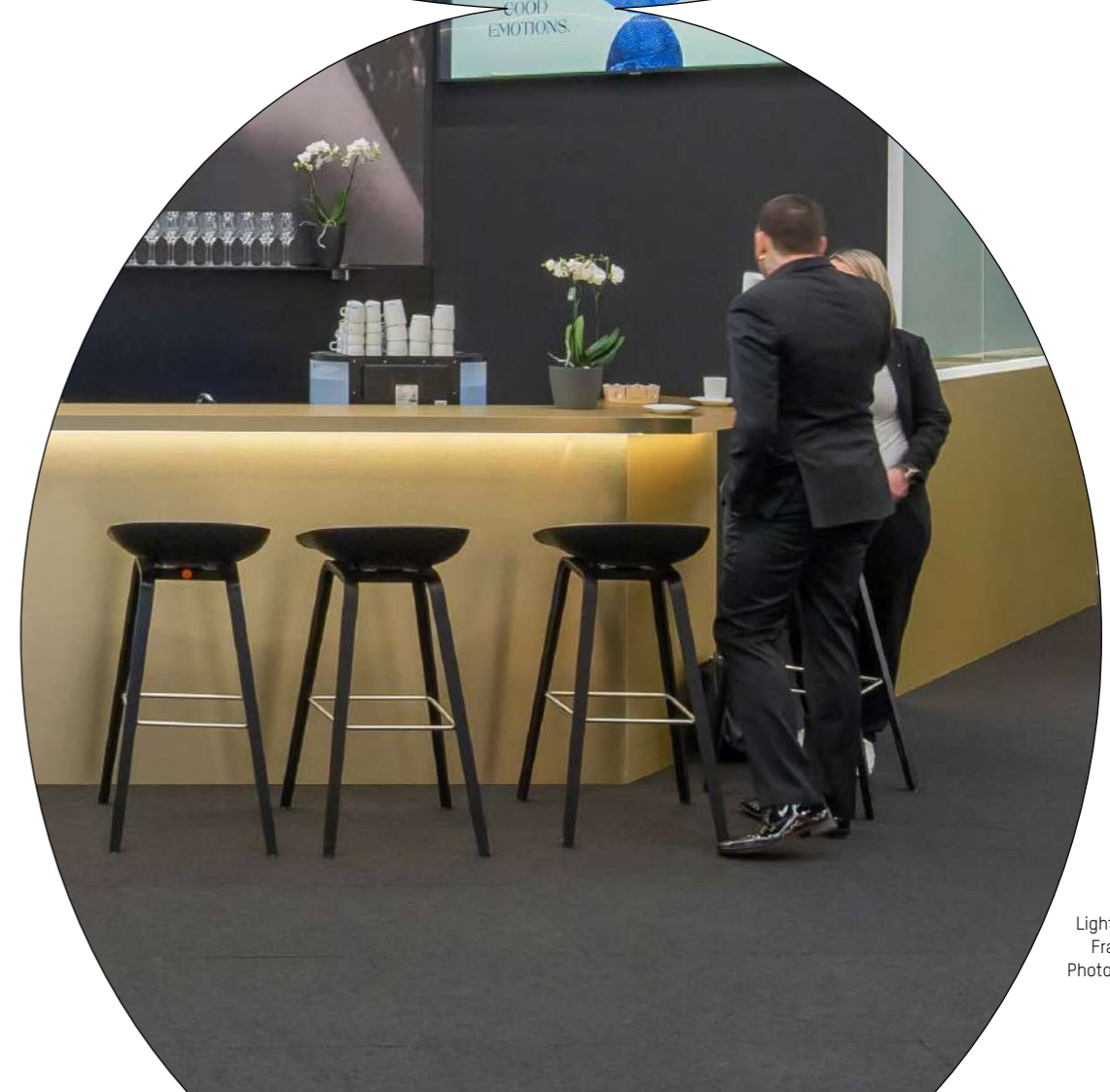
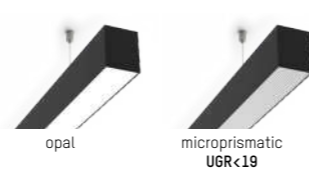



Dr. Haim, Vomp, Austria, Photo: Joachim Rauch

LOG 50 SYSTEM CONFIGURATOR

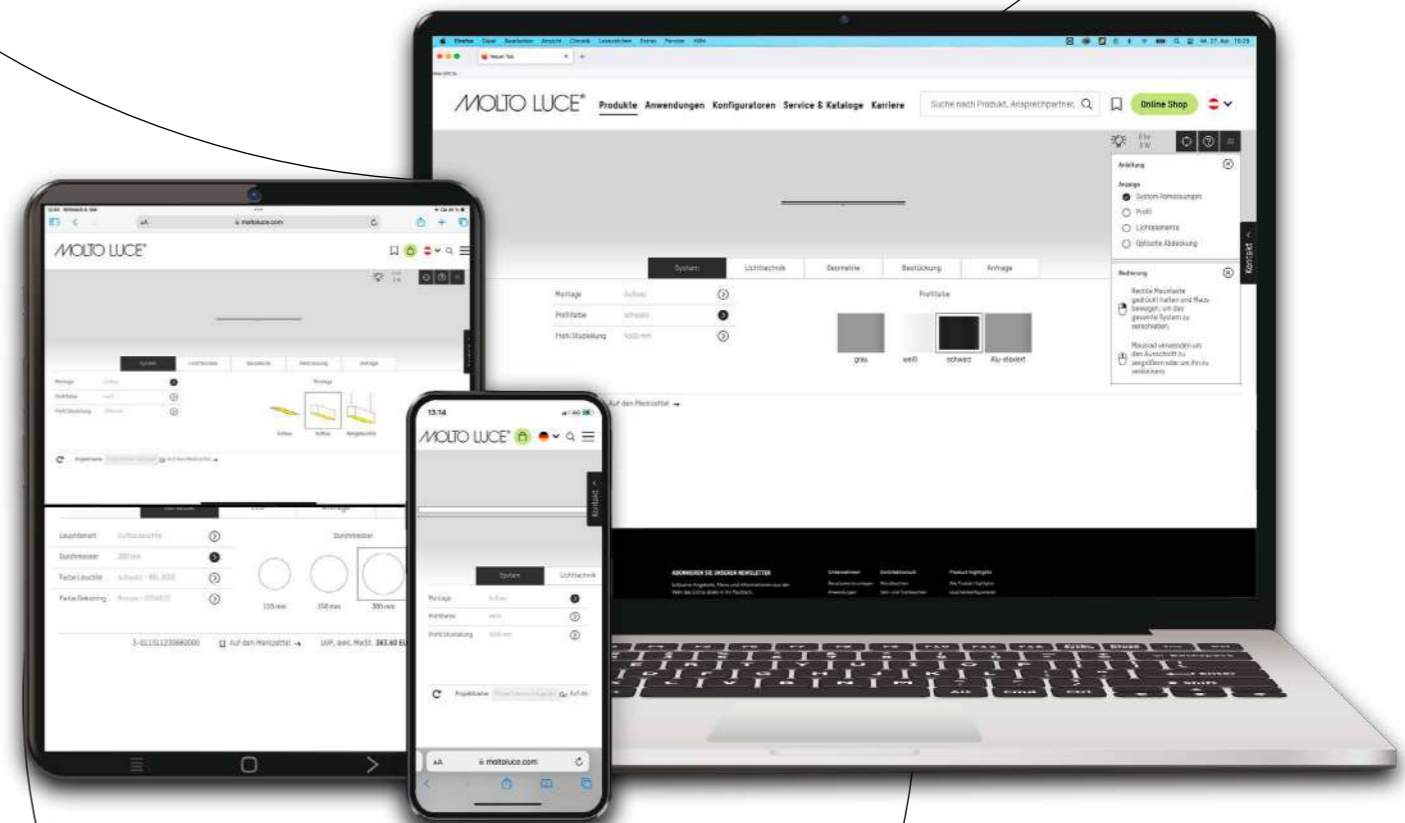

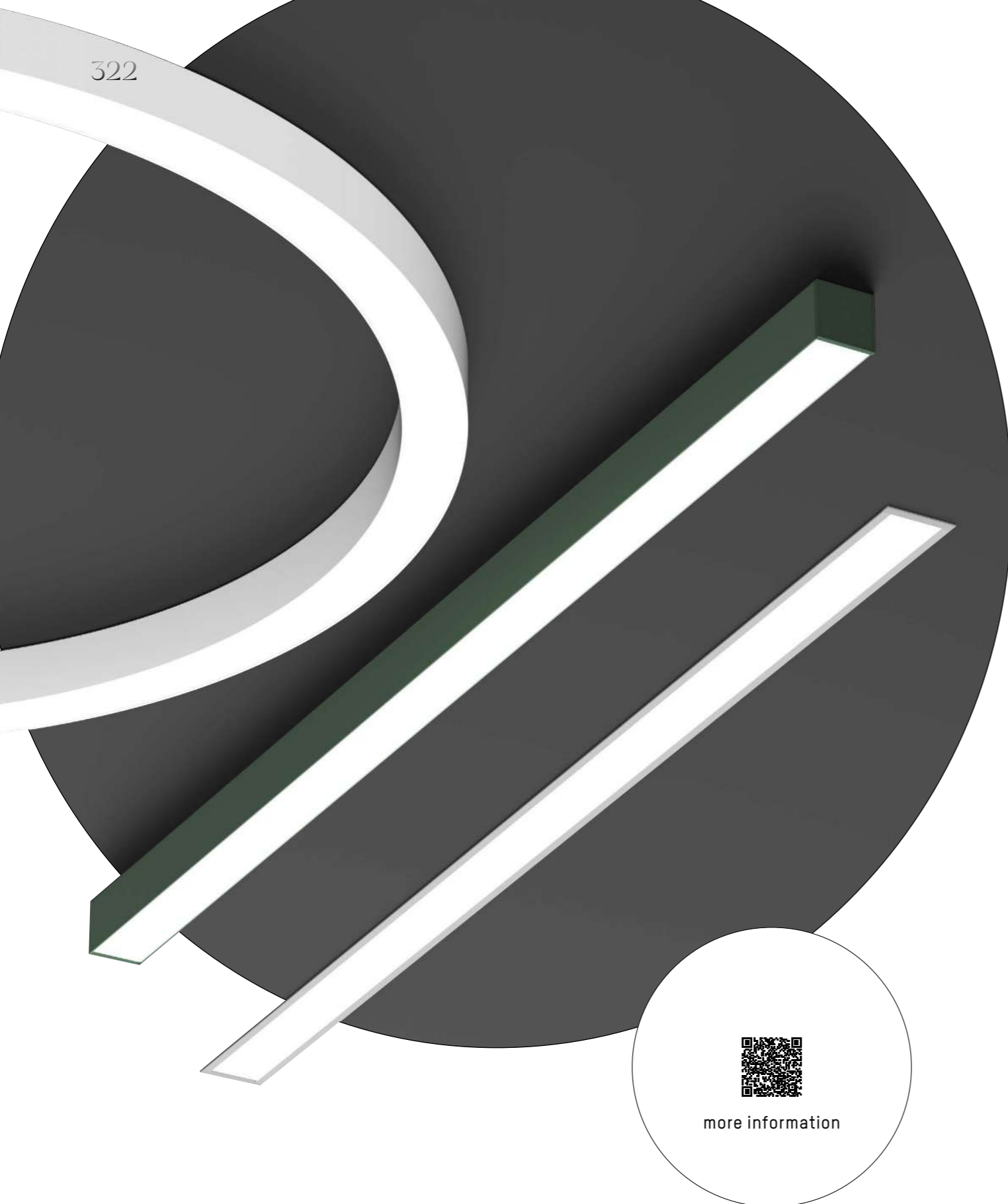

more information

RIDE



Object Carpet GmbH / City of Visions, Denkendorf, Germany, Photo: Markus Guhl



Wimberger Haus, Austria, Photo: Joachim Rauch



Raiffeisenbank Attersee-Süd, Nußdorf, Austria, Design + Architektur AREA.at
Photo: Joachim Rauch

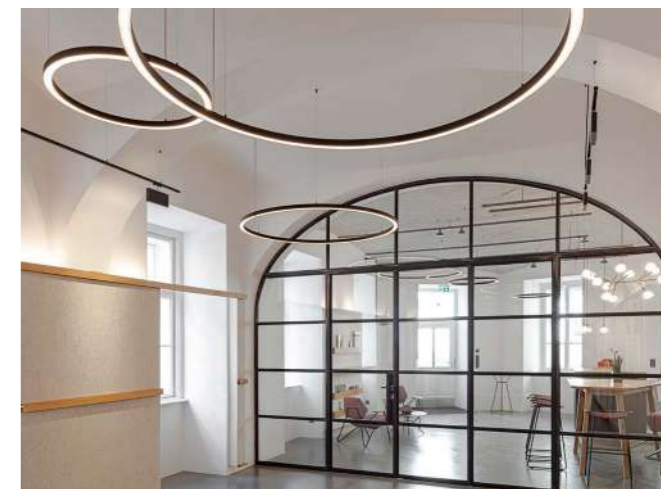

Wohnfonds MSG, Vienna, Austria, MSG Innenarchitektur & Bauplanungs GmbH /
facebook.com/MayrundGlatz, Photo: Gabriel Büchelmeier



Huber, Winklarn, Germany, Photo: Joachim Rauch



Private residence, Austria, Photo: Joachim Rauch

RIDE



Saller & Saller Steuerberatungskanzlei
Bischofshofen, Austria
Photo: Stefan Zauner

WIDE RANGE OF LIGHT AND SHAPES

Ride ist mit einem Querschnitt von nur 35x35mm eines der schlichsten LED-Lichtbandsysteme, die auf dem Markt angeboten werden. Das Besondere: Ride stellt aufgrund eines im System integrierten Konverters auch bei Längen von bis zu 15m einen durchgängigen Lichtaustritt sicher. Gefertigt aus einem stranggepressten Aluminiumprofil bringt Ride eine enorme Varianten-Vielfalt mit sich um unterschiedliche Erfordernisse abzudecken.

With a cross-section of just 35x35mm, Ride is one of the slimmest linear LED profile systems on the market. Due to an integrated converter, Ride can guarantee continuous light emission along lengths of up to 15m. Made from an extruded aluminum profile, Ride offers an enormous variety of variants to cover different requirements.

Design: INHOUSE

VARIATIONS

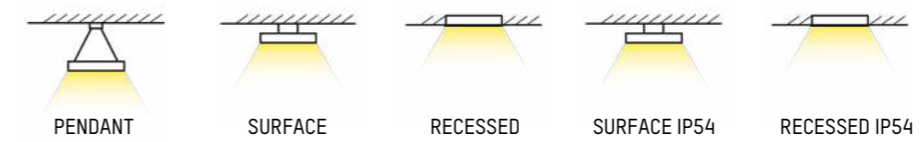

PROFILE

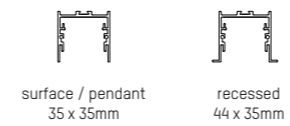

FORM

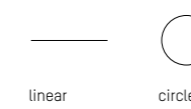

LED COLOURS



CORE COLOURS

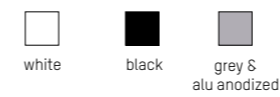

CREATIVE COLOURS

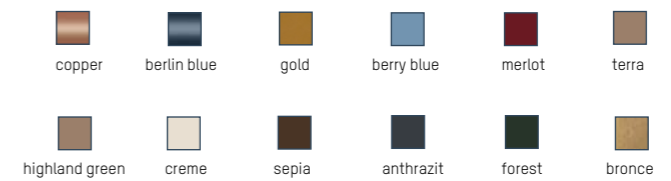

COVER OPTIONS





MSG, Hohenau, Germany, Photo: Joachim Rauch

RIDE RING PD

RIDE RING PD

220-240V AC 50/60Hz Design: INHOUSE

IP20

LED Ringleuchte aus Aluprofil · Oberfläche pulverbeschichtet · LED Konverter im Leuchtenprofil integriert · für Decken- und Wandmontage geeignet
 LED ring luminaire, extruded aluminium · surface powder-coated · built-in LED converter in profile · suitable for wall and ceiling installatio
 Lampada in alluminio estruso · superficie verniciata a polveri · converter LED integrato nel profilo · adatta per il montaggio a parete o a soffitt
 Lampe en forme d'anneau en aluminium extrudé · surface lacquée en poudre · convertiseur intégré dans le profil

CODE	SYS W	Ø mm	LUMEN
675-2010110WWXXY	38	750	3300 - 3730
675-2020110WWXXY	76	1450	6610 - 7470

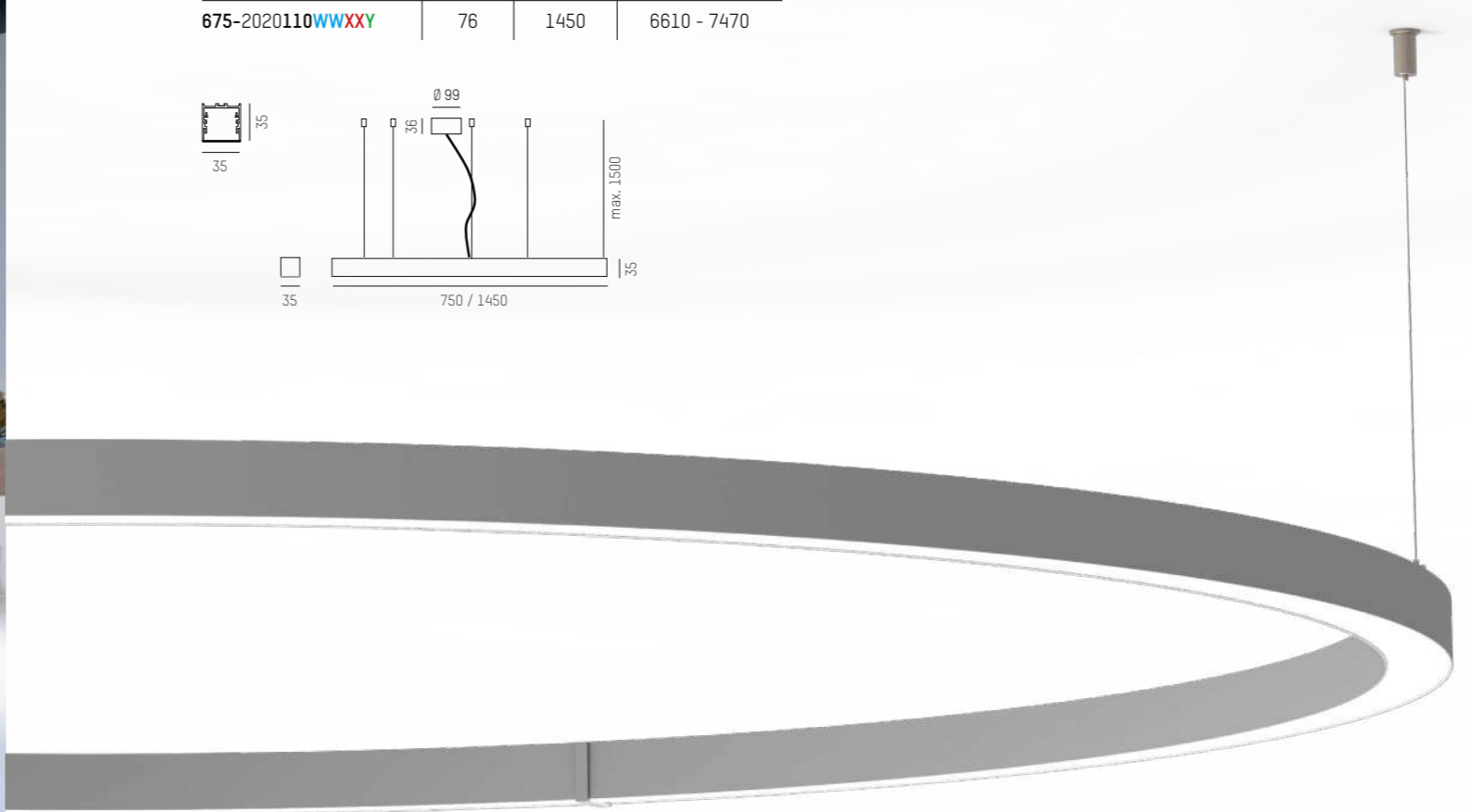
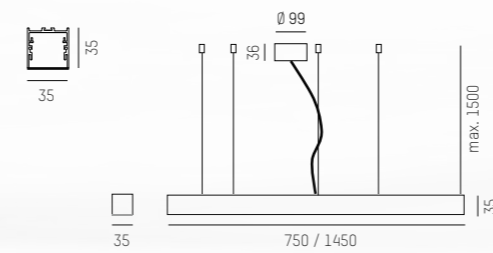

COMPLETE CODE																
WW = LIGHT COLOUR	XX = COLOUR	Y = DIMMABLE														
<table border="0"> <tr> <td> W2</td> <td>LED 2700K = 23 CRI>90</td> </tr> <tr> <td> W3</td> <td>LED 3000K = 29 CRI>90</td> </tr> <tr> <td> W4</td> <td>LED 4000K = 24 CRI>90</td> </tr> </table>	W2	LED 2700K = 23 CRI>90	W3	LED 3000K = 29 CRI>90	W4	LED 4000K = 24 CRI>90	<table border="0"> <tr> <td> G</td> <td>grey = 04</td> </tr> <tr> <td> W</td> <td>white = 05</td> </tr> <tr> <td> S</td> <td>black = 06</td> </tr> </table>	G	grey = 04	W	white = 05	S	black = 06	<table border="0"> <tr> <td> D</td> <td>DALI dim = d</td> </tr> </table>	D	DALI dim = d
W2	LED 2700K = 23 CRI>90															
W3	LED 3000K = 29 CRI>90															
W4	LED 4000K = 24 CRI>90															
G	grey = 04															
W	white = 05															
S	black = 06															
D	DALI dim = d															





RIDE RING SD

RIDE RING SD

220-240V AC 50/60Hz Design: INHOUSE

IP20

LED Ringleuchte aus Aluprofil · Oberfläche pulverbeschichtet · LED Konverter im Leuchtenprofil integriert · für Decken- und Wandmontage geeignet
 LED ring luminaire, extruded aluminium · surface powder-coated · built-in LED converter in profile · suitable for wall and ceiling installation
 Lampada in alluminio estruso · superficie verniciata a polveri · converter LED integrato nel profilo · adatta per il montaggio a parete o a soffitto
 Lampe en forme d'anneau en aluminium extrudé · surface lacquée en poudre · convertiseur intégré dans le profil

CODE	SYS W	Ø mm	LUMEN
675-1010110WWXXY	38	750	3300 - 3730
675-1020110WWXXY	76	1450	6610 - 7470

DECKENDISTANZ / CEILING DISTANCE

675-418000000XX	kurz / short
675-419000000XX	lang / long

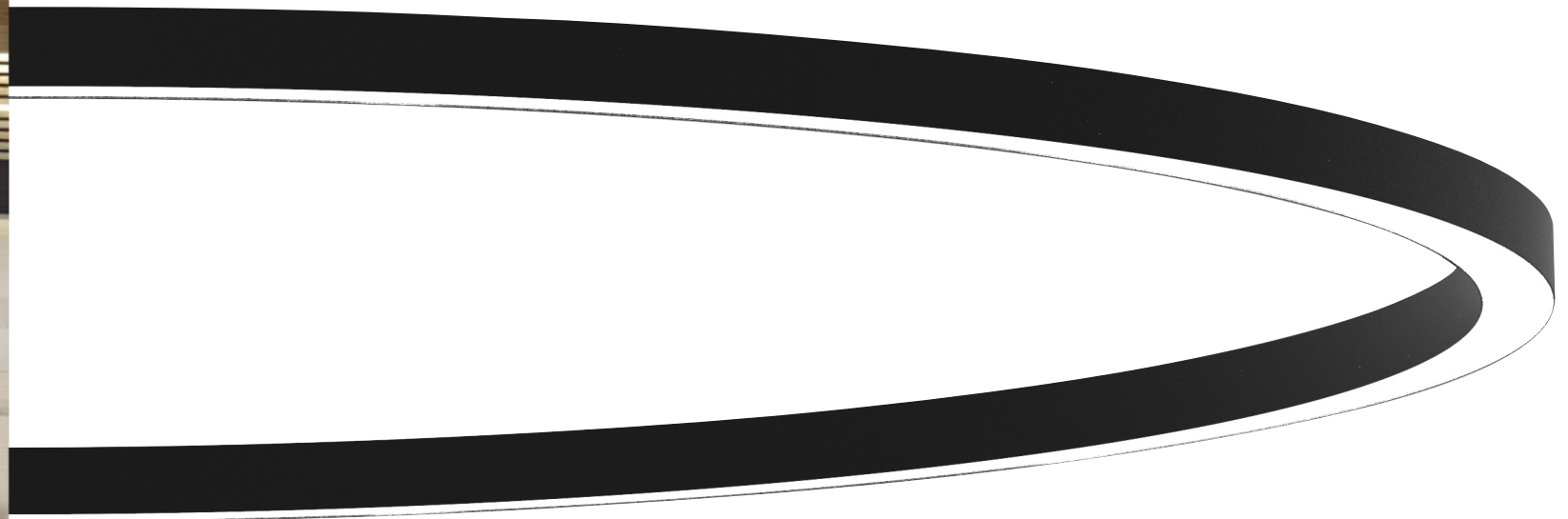
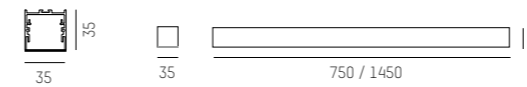

COMPLETE CODE

WW = LIGHT COLOUR	XX = COLOUR	Y = DIMMABLE
W2 LED 2700K = 23 CRI>90	G grey = 04	D DALI dim = d
W3 LED 3000K = 29 CRI>90	W white = 05	
W4 LED 4000K = 24 CRI>90	S black = 06	



Tourismusverband Obertauern, Austria, GMP Architektur ZT KG, www.gmp-architektur.at



Object Carpet GmbH / City of Visions, Denkendorf, Germany, Photo: Markus Guhl

RIDE PD

RIDE PD

220-240V AC 50/60Hz Design: INHOUSE

IP20

LED Pendelleuchte aus Aluprofil · Oberfläche pulverbeschichtet oder eloxiert · Opale oder mikroprismatische Abdeckung · Schaltbar oder DALI dimm.
 LED pendant luminaire from aluminium profile · surface powder-coated or anodized · opal or microprismatic cover · switchable or DALI dimmable
 Lampada LED con profilo in alluminio · Superficie verniciata a polveri o anodizzata · Diffusore opale o microprismatico · On/off o dimmerabile DALI
 Profil en aluminium pressé de LED · surface lacquée en poudre ou anodisée · Diffuseur opale ou microprismatique · On/off ou dimmable DALI

CODE	SYS W	L mm	LUMEN
577-01202C0WWXXY	15	857	1170 - 1570
577-01203C0WWXXY	19	1137	1560 - 2100
577-01204C0WWXXY	24	1417	1950 - 2620
577-01205C0WWXXY	48	2817	3910 - 5250
577-01206C0WWXXY	71	4217	5870 - 7870

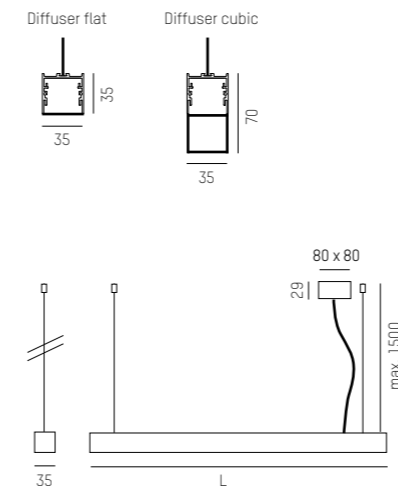

COMPLETE CODE			
C = COVER	WW = LIGHT COLOUR	XX = COLOUR	Y = DIMMABLE
opal flat = 1	LED 2700K = 23 CRI>90	white = 05	switchable = 0
opal cubic = 2	LED 3000K = 29 CRI>90	black = 06	DALI dim = d
microprismatic flat = 3	LED 4000K = 24 CRI>90	alu anodized = 08	





Raiffeisenbank Attersee-Süd, Nußdorf, Austria, Design + Architektur AREA.at, Photo: Joachim Rauch

RIDE SD

IP20

RIDE SD
220-240V AC 50/60Hz Design: INHOUSE

LED Aufbauleuchte aus Aluprofil · Oberfläche pulverbeschichtet oder eloxiert · Opale oder mikroprismatische Abdeckung · Schaltbar oder DALI dimm.
LED surface luminaire from aluminium profile · surface powder-coated or anodized · opal or microprismatic cover · switchable or DALI dimmable
Plafone LED a con profilo in alluminio · Superficie verniciata a polveri o anodizzata · Diffusore opale o microprismatico · On/off o dimmerabile DALI
Plafonnier LED en profilé d'aluminium · surface lacquée en poudre ou anodisée · Diffuseur opale ou microprismatique · On/off ou dimmable DALI

CODE	SYS W	L mm	LUMEN
577-01001C0WWXX0	10	577	780 - 1050
577-01003C0WWXXY	15	857	1170 - 1570
577-01003C0WWXXY	19	1137	1560 - 2100
577-01004C0WWXXY	24	1417	1950 - 2620
577-01005C0WWXXY	48	2817	3910 - 5250
577-01006C0WWXXY	71	4217	5870 - 7870

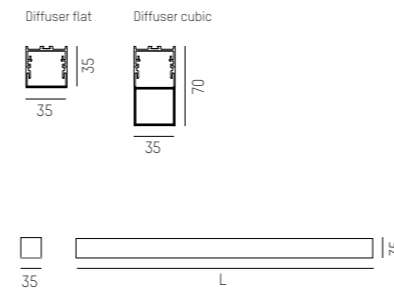

COMPLETE CODE			
C = COVER	WW = LIGHT COLOUR	XX = COLOUR	Y = DIMMABLE
opal flat = 1	LED 2700K = 23 CRI>90	white = 05	switchable = 0
opal cubic = 2	LED 3000K = 29 CRI>90	black = 06	DALI dim = d
microprismatic flat = 3	LED 4000K = 24 CRI>90	alu anodized = 08	





Hotel Südstern, Munich, Germany, Photo: Joachim Rauch

RIDE IP54 SD

RIDE IP54 SD

220-240V AC

50/60Hz

Design: INHOUSE





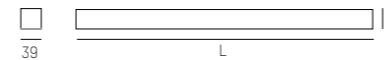
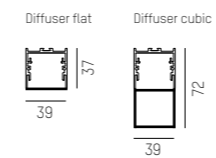

IP54  

LED Aufbauleuchte aus Aluminiumprofil · Oberfläche pulverbeschichtet oder eloxiert · Opale Abdeckung · Schaltbar oder DALI dimmbar · IP54
 LED surface luminaire from aluminium profile · surface powder-coated or anodized · opal cover · switchable or DALI dimmable · IP54
 Lampada LED a plafone con profilo in alluminio · Superficie verniciata a polveri o anodizzata · Diffusore opale · On/off o dimmerabile DALI · IP54
 Plafonnier LED en profilé d'aluminium · surface lacquée en poudre ou anodisée · Diffuseur opale · On/off ou dimmable DALI · IP54

CODE	SYS W	L mm	LUMEN
577-01301C0WWXX0	10	577	820 - 1050
577-01303C0WWXXY	15	857	1230 - 1570
577-01303C0WWXXY	19	1137	1650 - 1860
577-01304C0WWXXY	24	1417	2060 - 2620
577-01305C0WWXXY	48	2817	4130 - 5250
577-01306C0WWXXY	71	4217	6190 - 7870



COMPLETE CODE

C = COVER	WW = LIGHT COLOUR	XX = COLOUR	Y = DIMMABLE
 opal flat = 1	 LED 2700K = 23 CRI>90	 white = 05	 switchable = 0
 opal cubic = 2	 LED 3000K = 29 CRI>90	 black = 06	 DALI dim = d
	 LED 4000K = 24 CRI>90	 alu anodized = 08	



Kortmann Beton, Schüttdorf, Germany, Photo: Arnt Haug

RIDE BLIND SI

RIDE BLIND SI

220-240V AC 50/60Hz Design: INHOUSE

IP20

LED Aufbauleuchte aus Aluprofil · Oberfläche pulverbeschichtet oder eloxiert · für Decken- und Wandmontage · kubische Abdeckung mit Blende
 LED surface luminaire from aluminium profile · surface powder-coated or anodized · for ceiling and wall mount · cubic diffuser with cover
 Lampada LED a plafone con profilo in alluminio · Superficie verniciata a polveri o anodizzata · per soffitto e a parete · diffusore cubico a blenda
 Plafonnier LED en profilé d'aluminium · surface laquée en poudre ou anodisée · pour installation à plafond ou paroi · diffuseur cubique avec blende

CODE	SYS W	L mm	LUMEN
577-0080120 WWXX0	10	597	460 - 520
577-0080220 WWXXY	15	877	690 - 780
577-0080320 WWXXY	19	1157	920 - 1040
577-0080420 WWXXY	24	1437	1150 - 1300

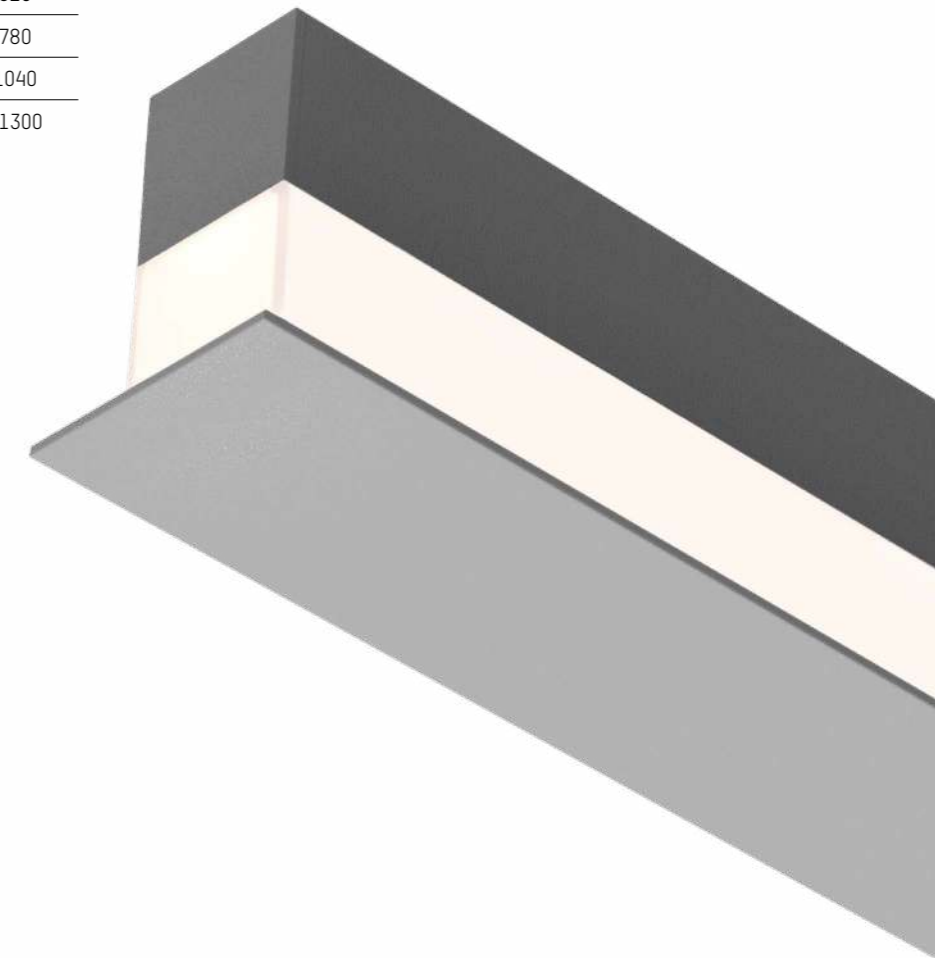
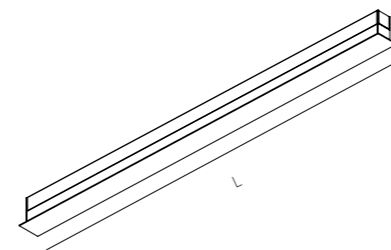
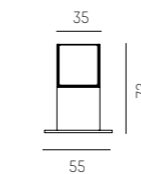

COMPLETE CODE

WW = LIGHT COLOUR		XX = COLOUR	Y = DIMMABLE
W2	LED 2700K = 23 CRI>90	W white = 05	S switchable = 0
W3	LED 3000K = 29 CRI>90	S black = 06	D DALI dim = d
W4	LED 4000K = 24 CRI>90	AE alu anodized = 08	



Truckcenter Katzinger, Altenfelden, Austria, Planning: Leibez Interieur Design, Photo: Stöbich

RIDE R

IP20

RIDE R
220-240V AC 50/60Hz Design: INHOUSE

LED Einbauleuchte aus Aluprofil · Oberfläche pulverbeschichtet oder eloxiert · Opale oder mikroprismatische Abdeckung · Schaltbar oder DALI dimm.
LED recessed luminaire from aluminium profile · surface powder-coated or anodized · opal or microprismatic cover · switchable or DALI dimmable
Lampada LED con profilo in alluminio · Superficie verniciata a polveri o anodizzata · Diffusore opale o microprismatico · On/off o dimmerabile DALI
Profil en aluminium pressé de LED · surface lacquée en poudre ou anodisée · Diffuseur opale ou microprismatique · On/off ou dimmable DALI

CODE	SYS W	L mm	LUMEN
577-01101C0WXX0	10	581	780 - 1050
577-01102C0WXXY	15	861	1170 - 1570
577-01103C0WXXY	19	1141	1560 - 2100
577-01104C0WXXY	24	1421	1950 - 2620
577-01105C0WXXY	48	2821	3910 - 5250
577-01106C0WXXY	71	4221	5870 - 7870

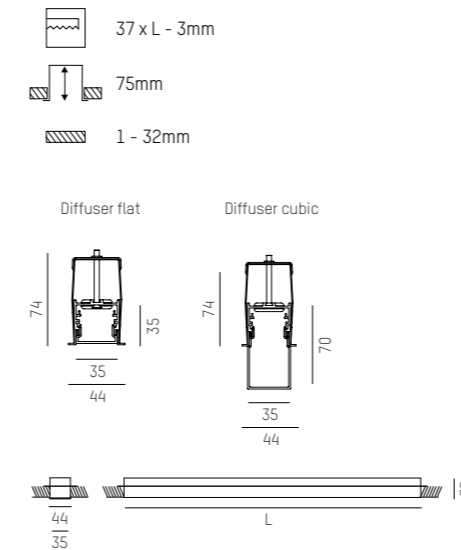

COMPLETE CODE			
C = COVER	WW = LIGHT COLOUR	XX = COLOUR	Y = DIMMABLE
opal flat = 1	LED 2700K = 23 CRI>90	white = 05	switchable = 0
opal cubic = 2	LED 3000K = 29 CRI>90	black = 06	DALI dim = d
microprismatic flat = 3	LED 4000K = 24 CRI>90	alu anodized = 08	



Private residence, Austria, Ostertag Architects ZT GmbH, Photo: Florian Frey

RIDE IP54 R

RIDE IP54 R

220-240V AC

50/60Hz

Design: INHOUSE

IP54  

LED Einbauleuchte aus Aluminiumprofil · Oberfläche pulverbeschichtet oder eloxiert · Opale Abdeckung · Schaltbar oder DALI dimmbar · IP54
 LED recessed luminaire from aluminium profile · surface powder-coated or anodized · opal cover · switchable or DALI dimmable · IP54
 Lampada LED con profilo in alluminio · Superficie verniciata a polveri o anodizzata · Diffusore opale · On/off o dimmerabile DALI · IP54
 Profil en aluminium pressé de LED · surface lacquée en poudre ou anodisée · Diffuseur opale · On/off ou dimmable DALI · IP54



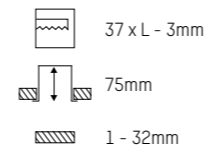



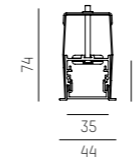

CODE	SYS W	L mm	LUMEN
577-0140110 WWXX0	10	606	820 - 930
577-0140210 WWXXY	15	886	1230 - 1400
577-0140310 WWXXY	19	1166	1650 - 1860
577-0140410 WWXXY	24	1446	2060 - 2330
577-0140510 WWXXY	48	2846	4130 - 4670
577-0140610 WWXXY	71	4246	6190 - 7000



Diffuser flat



COMPLETE CODE

WW = LIGHT COLOUR		XX = COLOUR	Y = DIMMABLE
 W2	LED 2700K = 23 CRI>90	 white = 05	 switchable = 0
 W3	LED 3000K = 29 CRI>90	 black = 06	 DALI dim = d
 W4	LED 4000K = 24 CRI>90	 alu anodized = 08	



ÖHA Liezen, Austria, Photo: Christoph Huber

RIDE LENS R

IP20

RIDE LENS R

220-240V AC 50/60Hz UGR>19 Design: INHOUSE

LED Einbauleuchte aus Aluprofil · Oberfläche pulverbeschichtet oder eloxiert · zurückversetzte Linsen und Hochglanzraster · perfekte Entblendung
 LED recessed luminaire from aluminium profile · surface powder-coated or anodized · recessed lenses and high-gloss grid · perfect anti-glare
 Lampada LED con profilo in alluminio · Superficie verniciata a polveri o anodizzata · lente retrocessa con griglia nero lucida · anti-abbagliamento
 Profil en aluminium pressé de LED · surface lacquée en poudre ou anodisée · optique placée en fond combinée avec darklight · anti-éblouissement

CODE	LED W	mA	L mm	LUMEN
634-002040RWWXX	6	500	113	440 - 550
634-002010RWWXX	17	500	304	1330 - 1650
634-002020RWWXX	31	900	590	2420 - 3000
634-002030RWWXX	47	1400	878	3630 - 4510

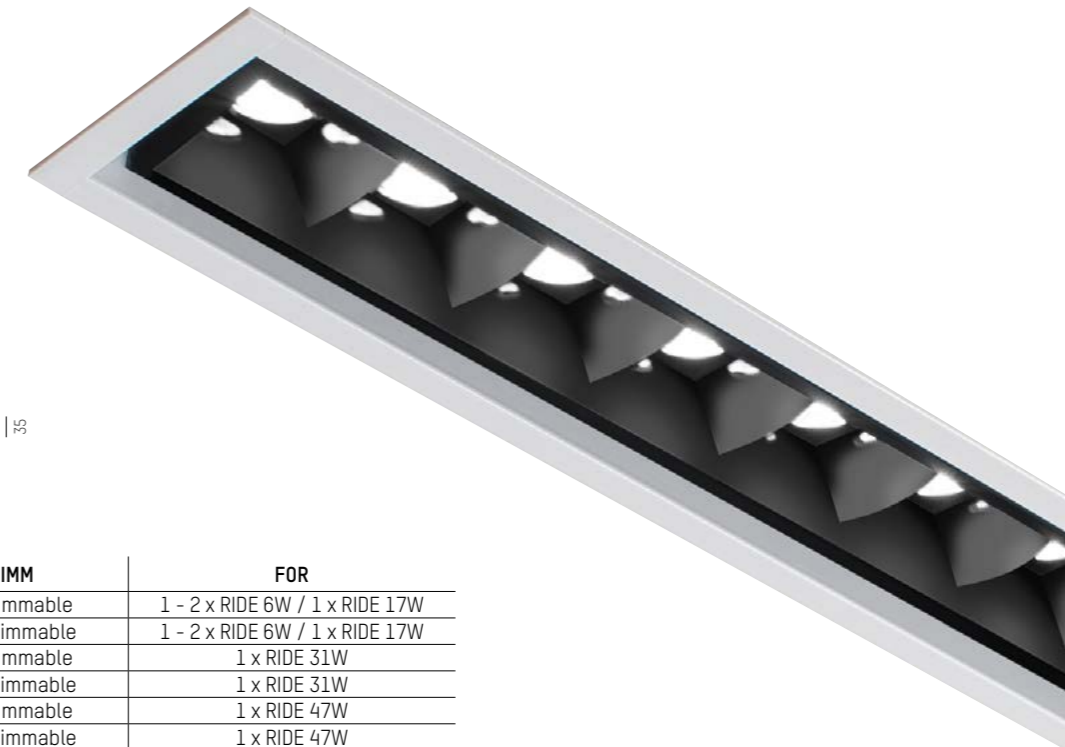
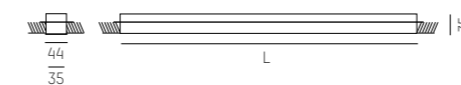
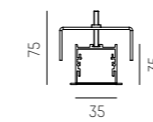
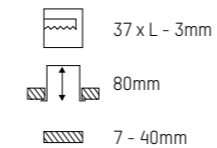

LED CONVERTER	mA	DIMM	FOR
24-122201	500	not dimmable	1 - 2 x RIDE 6W / 1 x RIDE 17W
24-151403	500	DALI dimmable	1 - 2 x RIDE 6W / 1 x RIDE 17W
24-122204	900	not dimmable	1 x RIDE 31W
24-15141350	900	DALI dimmable	1 x RIDE 31W
24-1222084	1400	not dimmable	1 x RIDE 47W
24-123170	1400	DALI dimmable	1 x RIDE 47W



COMPLETE CODE

R = REFLECTOR

- 15° = 1
- 34 + 15° = 6
- 45° = 3

WW = LIGHT COLOUR

- LED 2700K = 23 CRI>90
- LED 3000K = 29 CRI>90
- LED 4000K = 24 CRI>90

XX = COLOUR

- white = 05
- black = 06
- alu anodized = 08

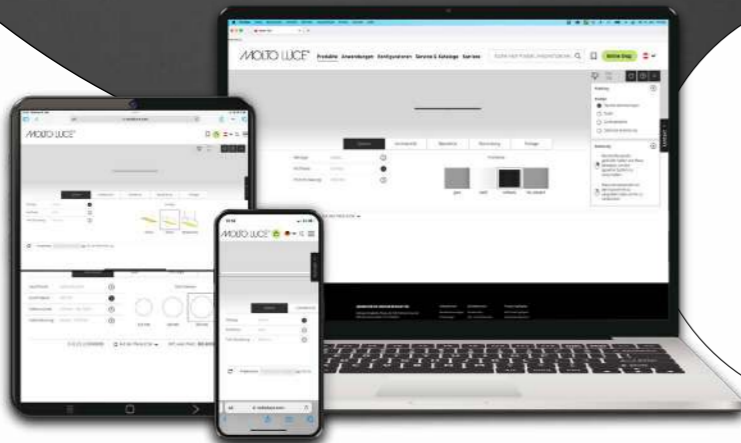
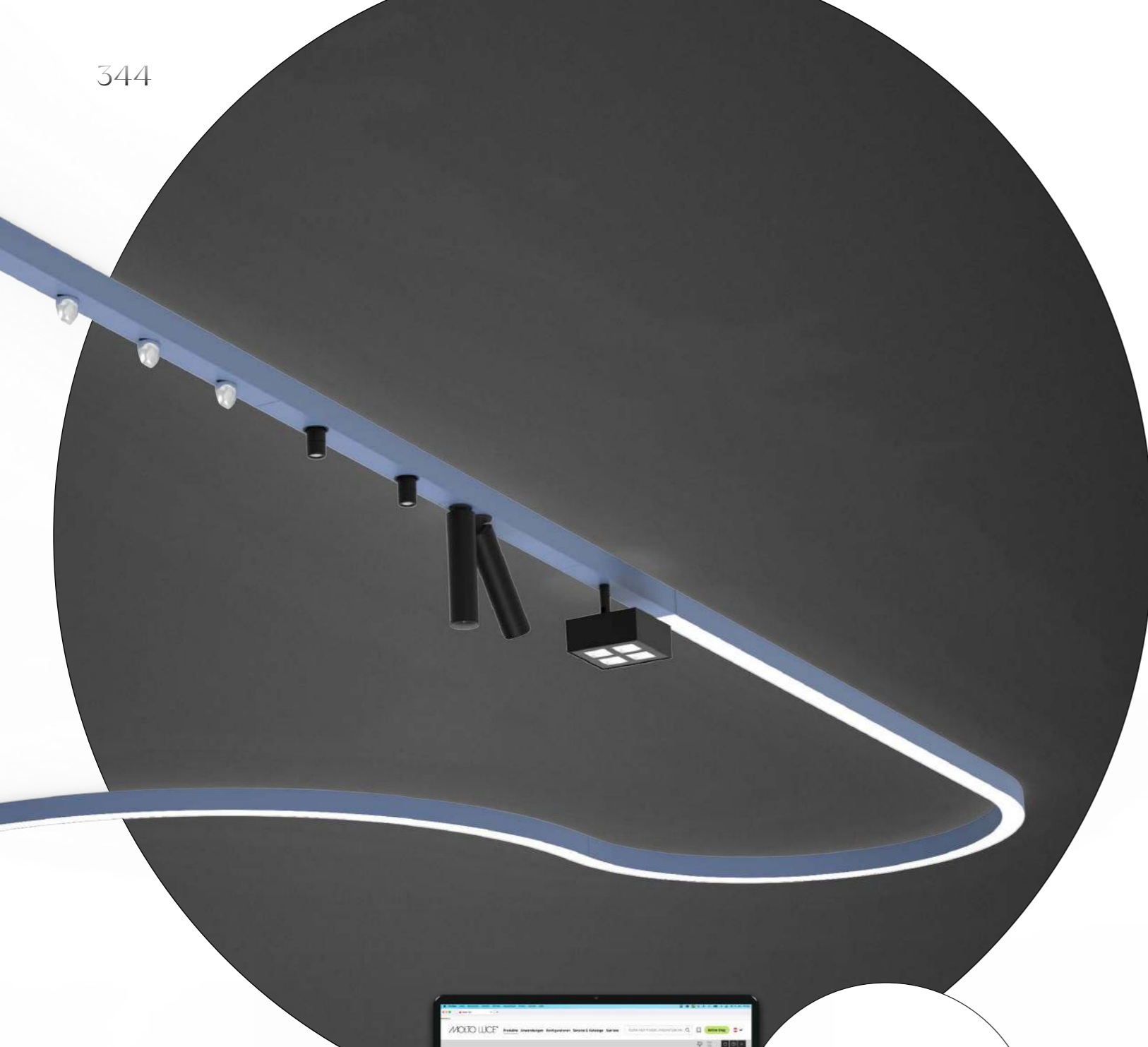

more information

RIDE SYSTEM



Tischlerei Berger, Ratten, Austria, Photo: Joachim Rauch



Private residence, Austria, Planning: Leibez Interior Design



Blick über Wien, Vienna, Austria, MSG Innenarchitektur & Bauplanungs GmbH
facebook.com/MayrundGlatzl, Photo: Gabriel Büchelmeier



Pre-school, Peggau, Austria, Photo: Joachim Rauch



Dr. Beck, Pfaffenhofen Germany, Photo: Joachim Rauch



Private residence, Italy, Project by E27, Padova

RIDE SYSTEM

VARIATIONS

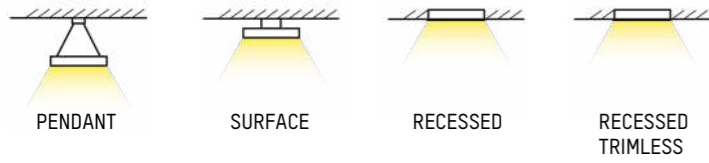

PROFILE

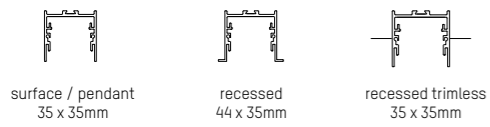

FORM



LED COLOURS



CORE COLOURS

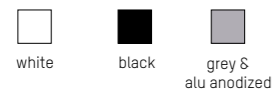

CREATIVE COLOURS

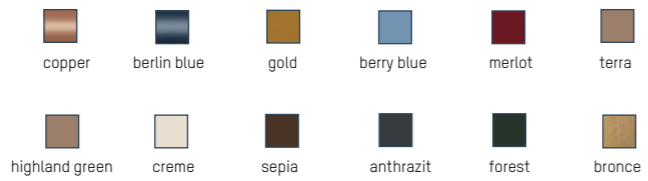

INSERTS



COVER OPTIONS



Private living, Austria,
Planning: Leibez Interior Design
Photo: Stöbich





Kommerzcenter Sparkasse, Rohrbach, Austria, Planning: Leibez Interior Design, Photo: Stöbich

RIDE SYSTEM CONFIGURATOR

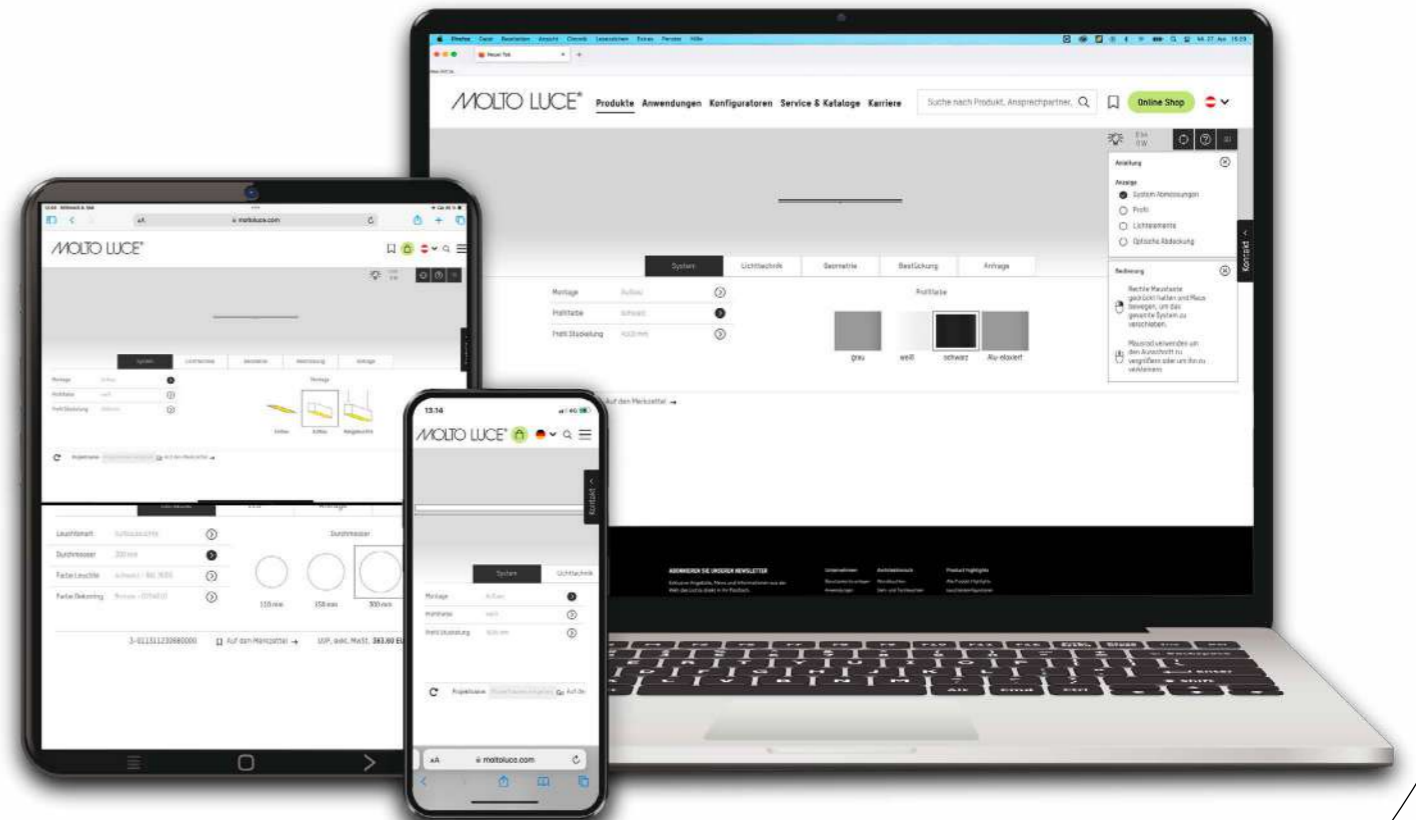

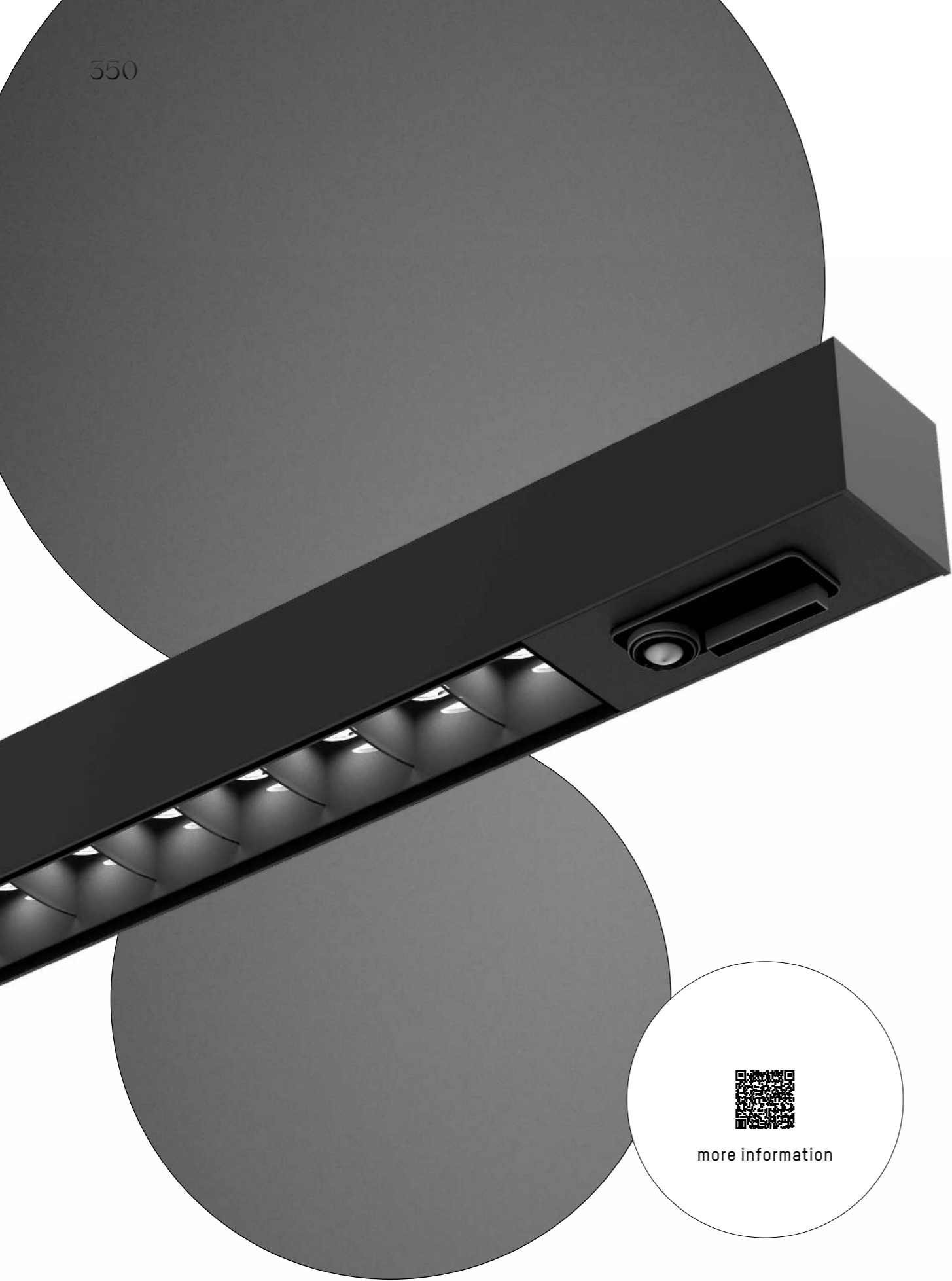

LENS



more information



Private residence, Austria, Leibets Interior Design, Foto: Stöbich

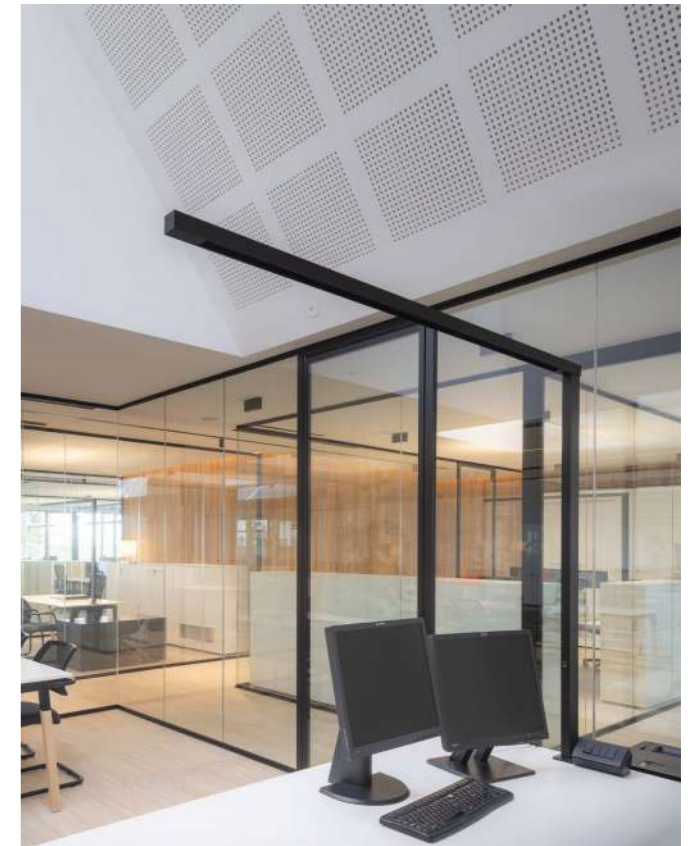

Ristrutturazione nuova sede Tyrolit, Bassano del Grappa, Italy
Photo: Marco Zanta



Work Experience Space , Cologne, Germany, Photo: Project Rheinland AG

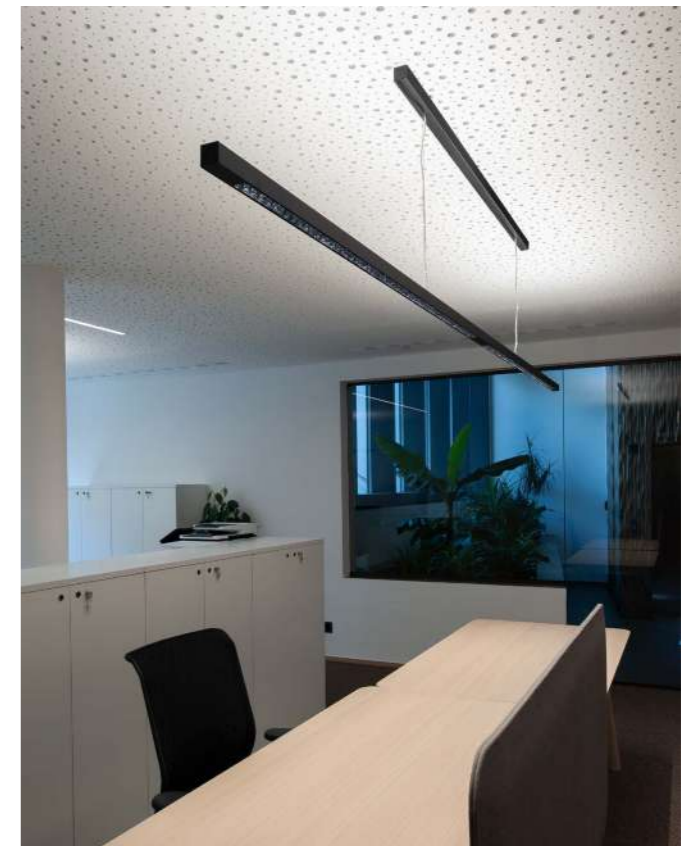

Raiffeisenbank Attersee-Süd, Nußdorf, Austria, Design + Architektur AREA.at
Photo: Joachim Rauch

LENS



Dr. Fischer, Baumgarten, Austria
Photo: Vrana Shopdesign

MINIMALISM IN PERFECTION

Mit Lens gelingt Molto Luce eine minimalistisch ansprechende Leuchtenserie für Einzel-, Doppel-, Dreifach- und Vierfcharbeitsplätze. Durch die tageslichtabhängige Steuerung mit Bewegungsmelder und Schwarmfunktion wird maximale Effizienz bei ebenso maximalem Nutzererlebnis ermöglicht. Perfekte Entblendung von UGR<16 erzielt Lens mittels eines schwarzen Hochglanzrasters in Kombination mit zurückversetzten, speziell abgestimmten Linsen. Mit einer direkt/indirekten Lichtverteilung im Verhältnis 40:60 bieten die modernen Leuchten der Serie Lens eine wirklich perfekte Arbeitsplatzbeleuchtung.

With Lens, Molto Luce has succeeded in creating an attractive minimalist luminaire range for single, double, triple and quad workstations. The daylight-dependent controls, with a motion sensor and swarm function not only provide maximum efficiency, but a maximum user experience as well. Lens achieves a perfect glare suppression with an UGR of <16, by means of a black high gloss louvre, combined with specially coordinated downward lenses. With a direct / indirect light distribution in a 40:60 ratio the contemporary luminaires of the Lens range offer absolutely perfect workstation illumination.

Design: INHOUSE

VARIATIONS

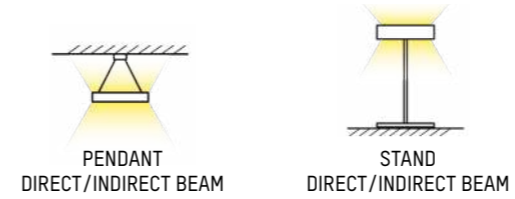

WORKPLACES

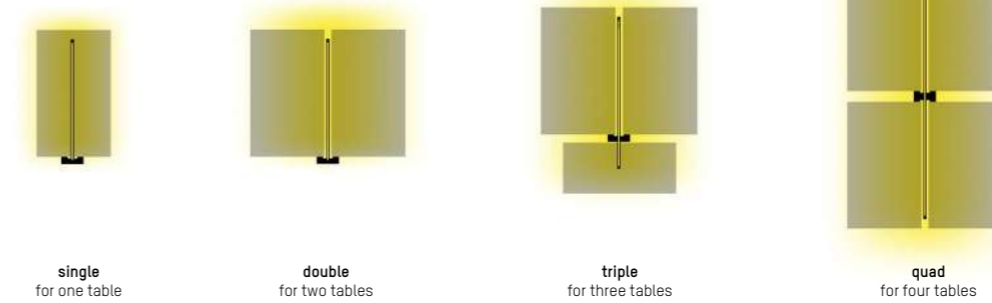

LED COLOURS



CORE COLOURS



CREATIVE COLOURS

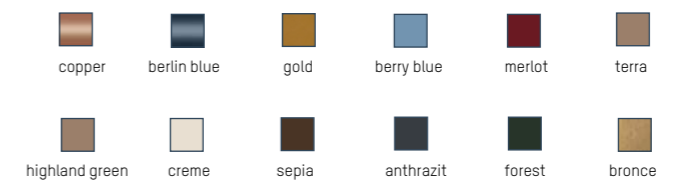

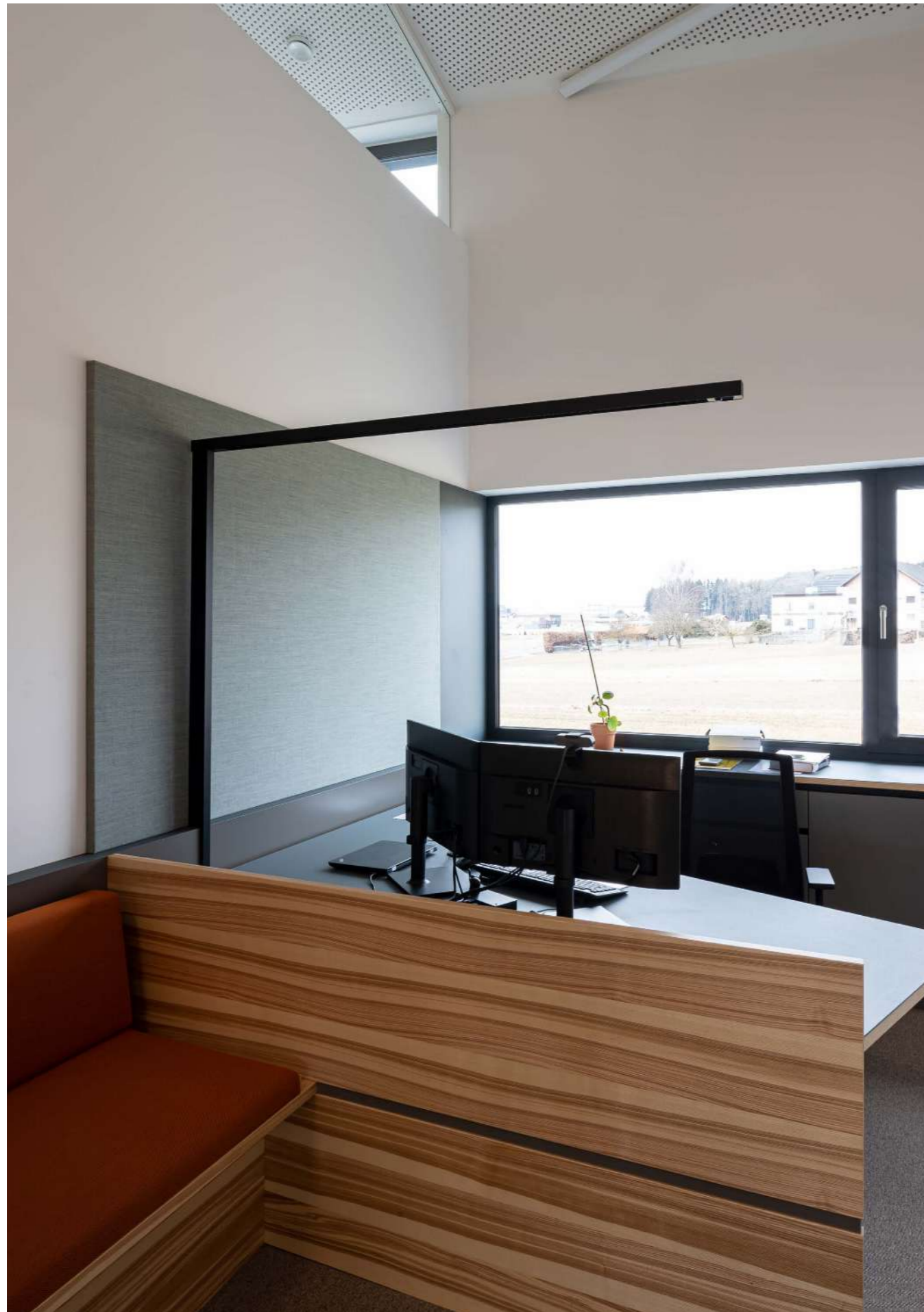

Nordfels, Bad Leonfelden, Austria, Photo: Joachim Rauch

LENS

LENS F

220-240V AC 50/60Hz CRI>80 UGR<16 Design: INHOUSE

IP20

Superschlanke LED Stehleuchte aus Aluminium · Oberfläche pulverbeschichtet oder eloxiert · Linsen mit Einzel- oder Doppelarbeitsplatz Optik · perfekte Entblendung durch schwarzen Hochglanzraster · mit Tageslichtsensor, Bewegungsmelder und Schwarmfunktion

Super-slim LED floor lamp in aluminium · surface powder-coated or anodized · recessed lens with single or double workstation optic · perfect anti-glare due to black high-gloss grid · daylight control, motion detector and wireless swarm network-function

Piantana a LED a ingombro ridotto in alluminio · superficie verniciata a polveri o anodizzata · lente retrocessa con ottica singola o doppia · anti-abbagliamento garantito da una griglia nera lucida · sensore di movimento e rilevatore quantità di luce e wireless funzione di rete

Lampadaire extra-fin à LED en aluminium · surface laquée en poudre ou anodisée · optique à émission simple ou double · grille basse-luminance · détecteur de mouvement, capteur de lumière et fonction réseau sans fil.

LENS SINGLE F

CODE	SYS W	LUMEN
646-1026103WWXXY	48	6350 - 6620

In der Mitte eines Arbeitsplatzes platzieren
Place in center of one workstation

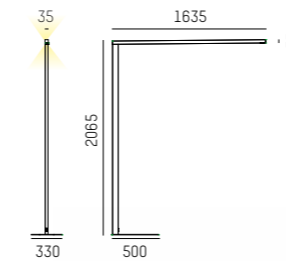

LENS DOUBLE F

CODE	SYS W	LUMEN
646-1026205WWXXY	100	11670 - 12020

In der Mitte von zwei Arbeitsplätzen platzieren
Place in center of two workstations

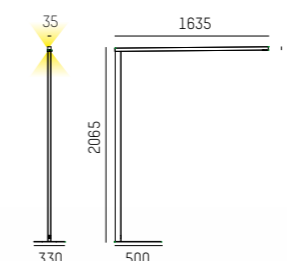

PUSH BUTTON MOTION SWARM

646-000040000050 ON / OFF & Dimm

646-000040000060 ON / OFF & Dimm

Optionaler radio push-button
Optional radio push-button

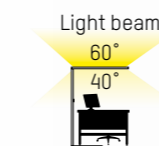
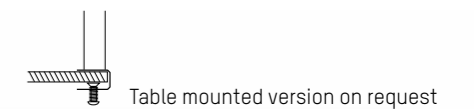
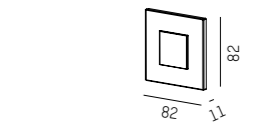

SINGLE



DOUBLE



COMPLETE CODE			
G = PUSH BUTTON	WW = LIGHT COLOUR	XX = COLOUR	Y = DIMMABLE
push button = 0	LED 3000K = 29	white = 05	switchable = 0
foil button = 1	LED 4000K = 24	black = 06	motion swarm = m (without foil or push button)
motion swarm = 0		aluminium anodized = 08	push-button dim = t
			motion daylight = k

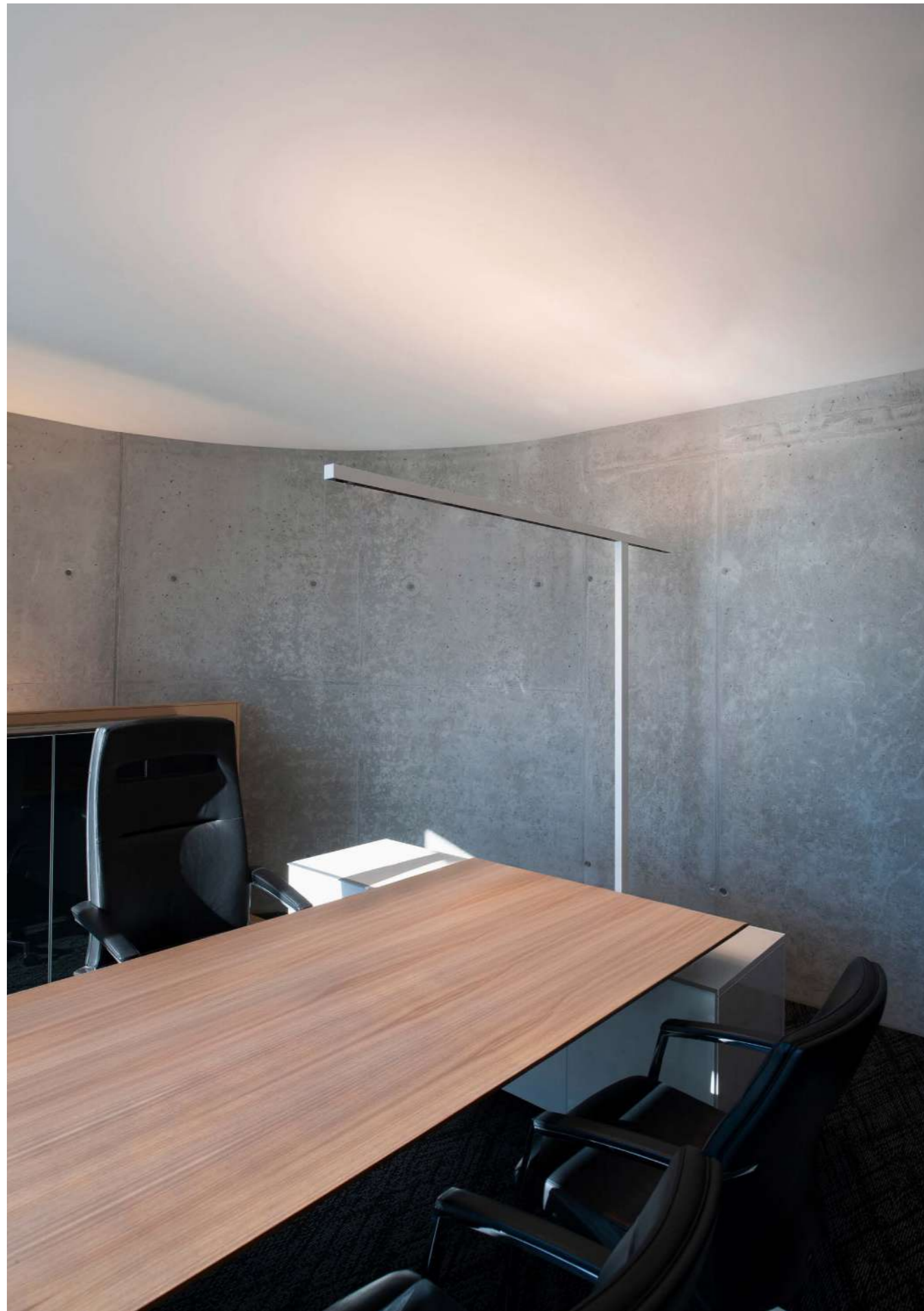

HALI Showroom, Salzburg, Austria, Photo: Joachim Rauch

LENS

LENS F

IP20

220-240V AC 50/60Hz CRI>80 UGR<16 Design: INHOUSE

Superschlänke LED Stehleuchte aus Aluminium · Oberfläche pulverbeschichtet oder eloxiert · Linsen mit Triple- oder Quadarbeitsplatz Optik · perfekte Entblendung durch schwarzen Hochglanzraster · mit Tageslichtsensor, Bewegungsmelder und Schwarmfunktion

Super-slim LED floor lamp in aluminium · surface powder-coated or anodized · recessed lens with triple or quad workstation optic · perfect anti-glare due to black high-gloss grid · daylight control, motion detector and wireless swarm network-function

Piantana a LED a ingombro ridotto in alluminio · superficie verniciata a polveri o anodizzata · lente retrocessa con ottica triplo o quadro · anti-abbagliamento garantito da una griglia nera lucida · sensore di movimento e rilevatore quantità di luce e wireless funzione di rete

Lampadaire extra-fin à LED en aluminium · surface laquée en poudre ou anodisée · optique à émission triple ou quad · grille basse-luminance · détecteur de mouvement, capteur de lumière et fonction réseau sans fil.

LENS TRIPLE F

CODE	SYS W	LUMEN
646-1126605WWXXY	100	11690 - 12020

In der Mitte von drei Arbeitsplätzen platzieren
Place in center of three workstations

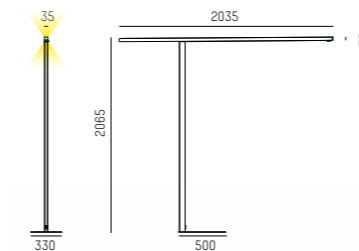

LENS QUAD F

CODE	SYS W	LUMEN
646-1076205WWXXY	200	23400 - 24000

In der Mitte von vier Arbeitsplätzen platzieren
Place in center of four workstations

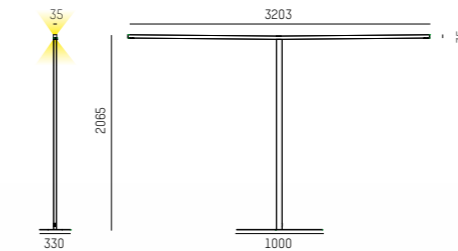

PUSH BUTTON MOTION SWARM

646-000040000050		ON / OFF & Dimm
646-000040000060		ON / OFF & Dimm

Optionaler radio push-button
Optional radio push-button

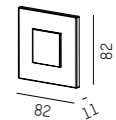

TRIPLE



QUAD



COMPLETE CODE			
G = PUSH BUTTON	WW = LIGHT COLOUR	XX = COLOUR	Y = DIMMABLE
push button = 0	LED 3000K = 29	white = 05	switchable = 0
foil button = 1	LED 4000K = 24	black = 06	motion swarm = m (without foil or push button)
motion swarm = 0		aluminium anodized = 08	push-button dim = t
			motion daylight = k



Kortmann Beton, Schüttorf, Germany, Photo: Arnt Haug



HP Ingenieure, Geretzried, Germany, © Jan Greune, hp-ingenieure.com

LENS SHORT

LENS SHORT F

220-240V AC 50/60Hz CRI>80 UGR<16 Design: INHOUSE

IP20

Superschlanke LED Stehleuchte aus Aluminium · Oberfläche pulverbeschichtet oder eloxiert · Linsen mit Einzel-, Doppel- oder Quadarbeitsplatz Optik · perfekte Entblendung durch schwarzen Hochglanzraster · mit Tageslichtsensor, Bewegungsmelder und Schwarmfunktion

Super-slim LED floor lamp in aluminium · surface powder-coated or anodized · recessed lens with single, double or quad workstation optic · perfect anti-glare due to black high-gloss grid · daylight control, motion detector and wireless swarm network-function

Piantana a LED a ingombro ridotto in alluminio · superficie verniciata a polveri o anodizzata · lente retrocessa con ottica singola, doppia o quadro · anti-abbagliamento garantito da una griglia nera lucida · sensore di movimento e rilevatore quantità di luce e wireless funzione di rete

Lampadaire extra-fin à LED en aluminium · surface laquée en poudre ou anodisée · optique à émission simple, double ou quad · grille basse-luminance · détecteur de mouvement, capteur de lumière et fonction réseau sans fil.

LENS SHORT SINGLE F

CODE	SYS W	LUMEN
646-1106103WWXXY	44	5850 - 6100

In der Mitte eines Arbeitsplatzes platzieren
Place in center of one workstation

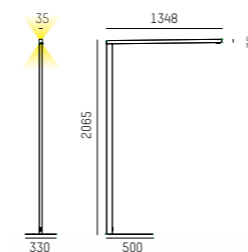

LENS SHORT DOUBLE F

CODE	SYS W	LUMEN
646-1106205WWXXY	90	10900 - 11200

In der Mitte von zwei Arbeitsplätzen platzieren
Place in center of two workstations

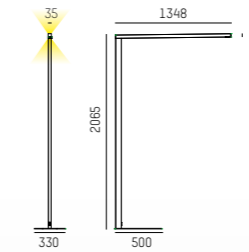

LENS SHORT QUAD F

CODE	SYS W	LUMEN
646-1156205WWXXY	179	21800 - 22500

In der Mitte von vier Arbeitsplätzen platzieren
Place in center of four workstations

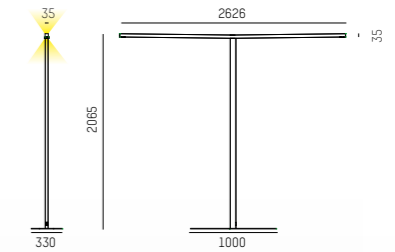

PUSH BUTTON MOTION SWARM

646-000040000050 ON / OFF & Dimm

646-000040000060 ON / OFF & Dimm

Optionaler radio push-button
Optional radio push-button

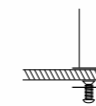
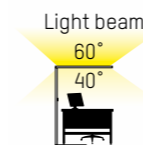
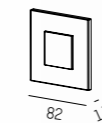

Table mounted version on request

SINGLE



DOUBLE



QUAD



COMPLETE CODE

G = PUSH BUTTON	WW = LIGHT COLOUR	XX = COLOUR	Y = DIMMABLE
push button = 0	LED 3000K = 29	white = 05	switchable = 0
foil button = 1	LED 4000K = 24	black = 06	motion swarm = m (without foil or push button)
motion swarm = 0		aluminium anodized = 08	push-button dim = t
			motion daylight = k



Raiffeisenbank Attersee-Süd, Nußdorf, Austria, Design + Architektur AREA.at, Photo: Joachim Rauch

LENS

LENS PDI

220-240V AC 50/60Hz CRI>80 UGR<16 Design: INHOUSE

IP20

Superschlanke LED Hängeleuchte aus Aluminium · Oberfläche pulverbeschichtet oder eloxiert · Linsen mit Einzel-, Doppel oder Quadarbeitsplatz Optik · perfekte Entblendung durch schwarzen Hochglanzraster · mit Tageslichtsensor, Bewegungsmelder und Schwarmfunktion

Super-slim LED suspension in aluminium · surface powder-coated or anodized · recessed lens with single, double or quad workstation optic · perfect anti-glare due to black high-gloss grid · daylight control, motion detector and wireless swarm network-function

Sospensione a LED a ingombro ridotto in alluminio · superficie verniciata a polveri o anodizzata · lente retrocessa con ottica singola, doppia o quadro · anti-abbagliamento garantito da una griglia nera lucida · sensore di movimento e rilevatore quantità di luce e wireless funzione di rete

Suspension extra-fin à LED en aluminium · surface laquée en poudre ou anodisée · optique à émission simple, double ou quad · grille basse-luminance · détecteur de mouvement, capteur de lumière et fonction réseau sans fil.

LENS SINGLE PDI

CODE	SYS W	LUMEN
646-1030103WWXXY	48	6350 - 6620

In der Mitte eines Arbeitsplatzes platzieren
Place in center of one workstation

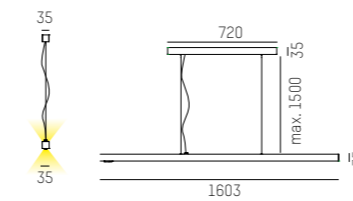

LENS DOUBLE PDI

CODE	SYS W	LUMEN
646-1030205WWXXY	100	11690 - 12020

In der Mitte von zwei Arbeitsplätzen platzieren
Place in center of two workstations

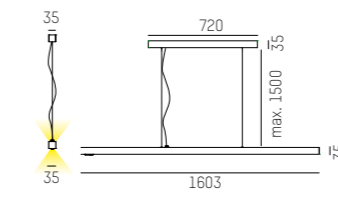

LENS QUAD PDI

CODE	SYS W	LUMEN
646-1050205WWXXY	200	23400 - 24000

In der Mitte von vier Arbeitsplätzen platzieren
Place in center of four workstations

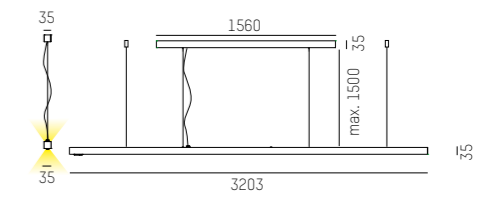

PUSH BUTTON MOTION SWARM

646-000040000050 ON / OFF & Dimm

646-000040000060 ON / OFF & Dimm

Optionaler radio push-button
Optional radio push-button

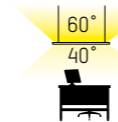
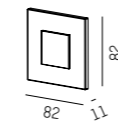

SINGLE



DOUBLE



QUAD



COMPLETE CODE

WW = LIGHT COLOUR	XX = COLOUR	Y = DIMMABLE
LED 3000K = 29	white = 05	switchable = 0
LED 4000K = 24	black = 06	motion swarm = m
	aluminium anodized = 08	motion daylight = k
		DALI dim = d



Office Project, Kufstein, Austria, Photo: Joachim Rauch

LENS SHORT

LENS SHORT PDI

220-240V AC 50/60Hz CRI>80 UGR<16 Design: INHOUSE

IP20

Superschlänke LED Hängeleuchte aus Aluminium · Oberfläche pulverbeschichtet oder eloxiert · Linsen mit Einzel-, Doppel oder Quadarbeitsplatz Optik · perfekte Entblendung durch schwarzen Hochglanzraster · mit Tageslichtsensor, Bewegungsmelder und Schwarmfunktion

Super-slim LED suspension in aluminium · surface powder-coated or anodized · recessed lens with single, double or quad workstation optic · perfect anti-glare due to black high-gloss grid · daylight control, motion detector and wireless swarm network-function

Sospensione a LED a ingombro ridotto in alluminio · superficie verniciata a polveri o anodizzata · lente retrocessa con ottica singola, doppia o quadro · anti-abbagliamento garantito da una griglia nera lucida · sensore di movimento e rilevatore quantità di luce e wireless funzione di rete

Suspension extra-fin à LED en aluminium · surface laquée en poudre ou anodisée · optique à émission simple, double ou quad · grille basse-luminance · détecteur de mouvement, capteur de lumière et fonction réseau sans fil.

LENS SHORT SINGLE PDI

CODE	SYS W	LUMEN
646-1080103WWXXY	44	5850 - 6100

In der Mitte eines Arbeitsplatzes platzieren
Place in center of one workstation

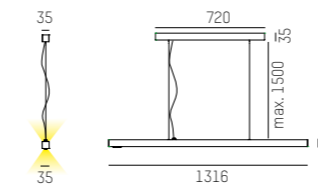

LENS SHORT DOUBLE PDI

CODE	SYS W	LUMEN
646-1080205WWXXY	90	11700 - 11200

In der Mitte von zwei Arbeitsplätzen platzieren
Place in center of two workstations

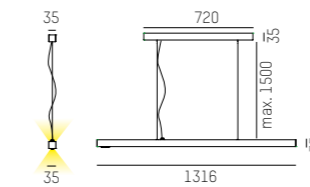

LENS SHORT QUAD PDI

CODE	SYS W	LUMEN
646-1130205WWXXY	177	21800 - 22500

In der Mitte von vier Arbeitsplätzen platzieren
Place in center of four workstations

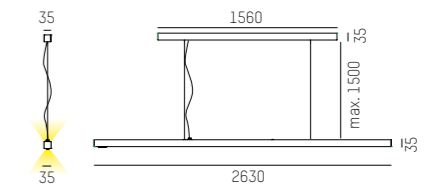

PUSH BUTTON MOTION SWARM

646-000040000050 ON / OFF & Dimm

646-000040000060 ON / OFF & Dimm

Optionaler radio push-button
Optional radio push-button

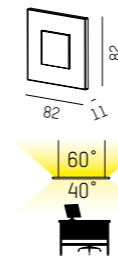

SINGLE



DOUBLE



QUAD



COMPLETE CODE

WW = LIGHT COLOUR	XX = COLOUR	Y = DIMMABLE
LED 3000K = 29	white = 05	switchable = 0
LED 4000K = 24	black = 06	motion swarm = m
	aluminium anodized = 08	motion daylight = k
		DALI dim = d

LENS 2



more information



Molto Luce fair stand, Light & Building Frankfurt Germany, Photo: Joachim Rauch

MINIMALISM IN PERFECTION – NEXT LEVEL

LENS 2 revolutioniert die Office-Beleuchtung mit einzigartiger, flächendeckender Sensormatrix-Technologie und modernstem, minimalistischem Design. Den Arbeitsplatz betreten und von einem sanften Licht willkommen heißen werden, dass sich perfekt an die Helligkeit des Tageslichts anpasst und dies zu jeder Zeit – dies ermöglicht die neue LENS2. Einfache Montage, mit nur wenigen Handgriffen und mit Einzelplatzerkennung für Tageslicht und Bewegungserkennung ausgestattet, wird nicht nur der Energieverbrauch optimiert, sondern auch Arbeitsumgebungen geschaffen, die sich an individuelle Bedürfnisse anpassen.

LENS 2 revolutionizes office lighting with unique, comprehensive sensor matrix technology and modern, minimalist design. Enter the workspace and be welcomed by a gentle light that perfectly adapts to the brightness of daylight at any time – this is what the new LENS 2 enables. Simple installation, with just a few steps and equipped with single user detection for daylight and motion detection, not only optimises energy consumption but also creates work environments that adapt to individual needs.

Design: INHOUSE

VARIATIONS

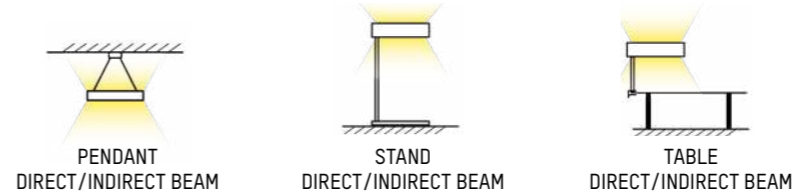

WORKPLACES

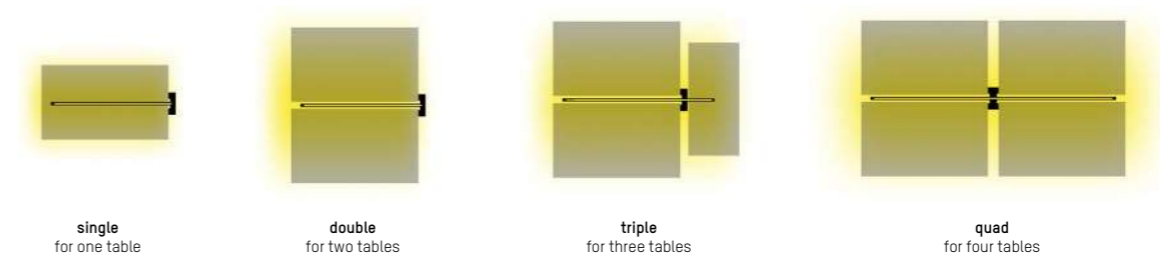

LED COLOURS



CORE COLOURS



CREATIVE COLOURS

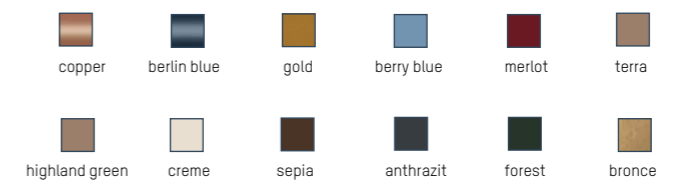

OPTICS



EASY MOUNTING

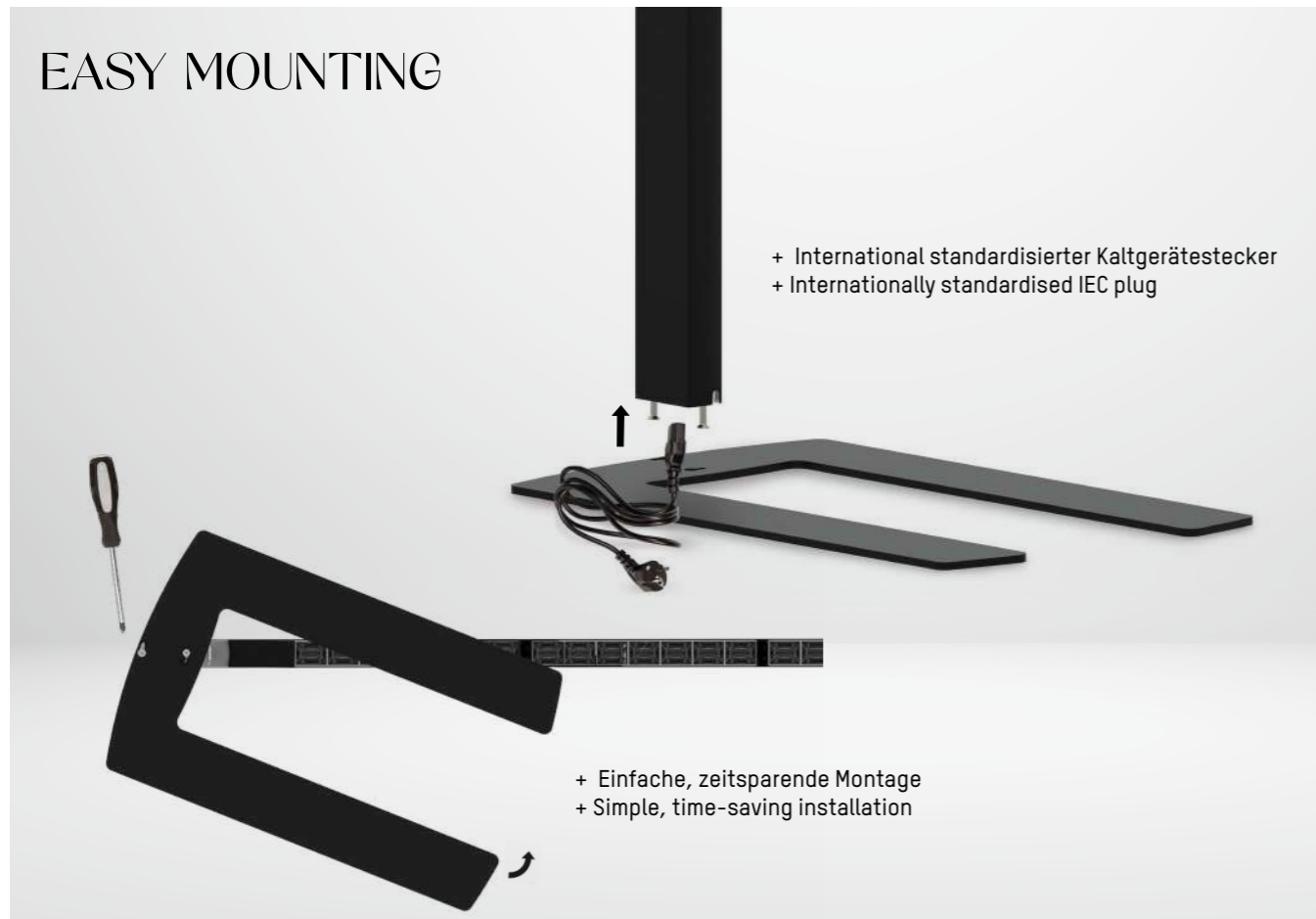

PLUG & PLAY



CUSTOMIZE YOUR LIGHT

- + Intuitive Touch-Bedienung und Individualisierung der vielfältigen Optionen
- + Intuitive touch operation and customisation of the wide range of options



BE IN BALANCE





LENS 2 COLOURS



Core Colours.

Die Farben Schwarz, Weiß und Grau bestimmen unser Kernsortiment.
The colours black, white and grey define our core range.



WEISS / WHITE



GRAU / GREY



SCHWARZ / BLACK



Creative Colours.

Ob Beerenblau, Merlot oder Hochlandgrün... unsere Creative Colours harmonieren perfekt mit unserem Produktsortiment und gleichzeitig auch mit den Farben der modernen Architektur.

Be it Berryblue, Merlot or Highlandgreen... our Creative Colours harmonise perfectly with our product range and simultaneously with the colours of modern architecture as well.



CREME / CREME



TERRA / TERRA



GOLD / GOLD



BRONZE / BRONZE



KUPFER / COPPER



MERLOT / MERLOT



BEERENBLAU / BERRYBLUE



BERLINERBLAU / BERLINBLUE



ANTHRAZIT / ANTHRACITE



HOCHLANDGRÜN / HIGHLANDGREEN



TANNENGRÜN / FOREST



SEPIA / SEPIA

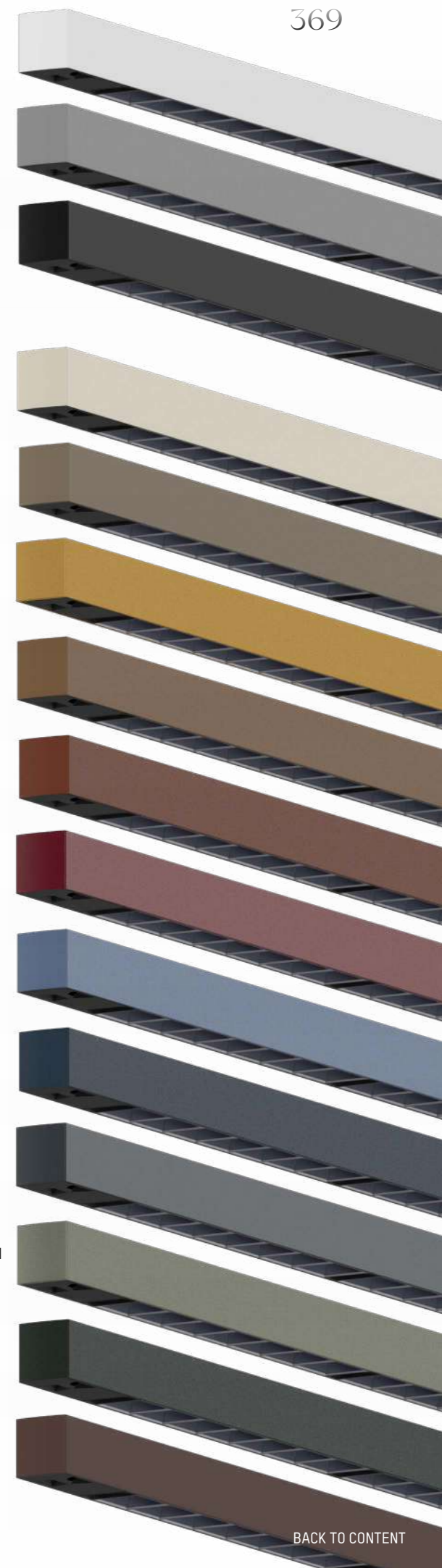

DIM 2 DAYLIGHT

Die Sensormatrix hebt Energieeffizienz auf ein neues Level. Fünf hochpräzise Licht-Sensoren überwachen kontinuierlich den Arbeitsplatz um die vorhandene Lichtmenge detailliert zu analysieren. Trifft beispielsweise Sonnenlicht durch das Fenster auf den Tisch, passt sich das Dim-Level abschnittsweise an die notwendigen Korrekturen an und garantiert damit auf dem gesamten Arbeitsplatz die eingestellte Beleuchtungsstärke von z.B. 500lux. Auch die indirekte Beleuchtung reagiert eigenständig darauf und ändert das Dim-Level (siehe Bild 1). Plötzlicher Wetterumschwung oder das Aufziehen von Wolken? Jede Veränderung der Lichtverhältnisse wird gemessen und in Echtzeit darauf reagiert und das Lichtlevel an die neuen Bedingungen angepasst (siehe Bild 2). Messen die Sensoren eine völlige Abdunkelung auf dem Tisch – sei es durch Rollos oder das Fehlen von Tageslicht aufgrund der Uhrzeit, erreicht das Dim-Level das Maximum. (siehe Bild 3).

The sensor matrix takes energy efficiency to a new level. Five high-precision light sensors continuously monitor the workspace to analyse the existing amount of light in detail. For example, if sunlight hits the desk through the window, the dim level adjusts in sections to the necessary corrections, ensuring the set lighting level of, e.g., 500 lux, throughout the entire workspace. Even the indirect lighting responds independently and adjusts the dim level. (see image 1) Sudden weather changes or clouds gathering? Every change in lighting conditions is measured and reacted to in real-time, adjusting the light level to the new conditions. (see image 2) If the sensors detect a complete darkening of the desk – whether due to blinds or the lack of daylight because of the time of day – the dim level reaches its maximum. (see image 3)

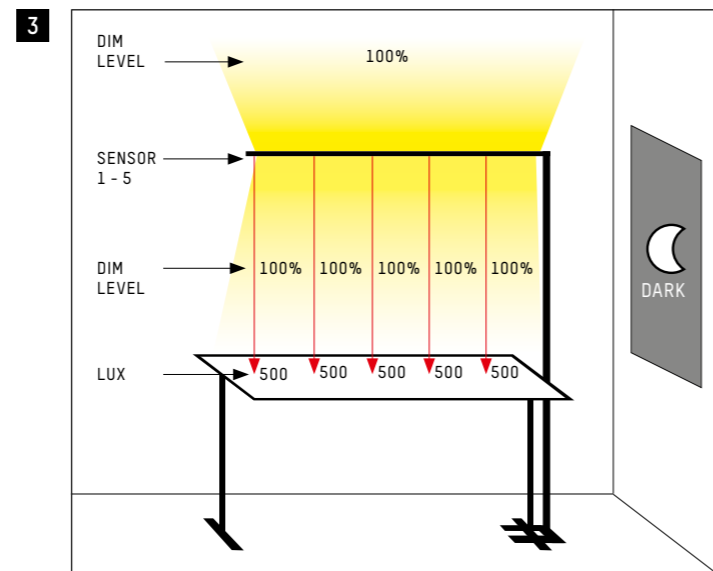
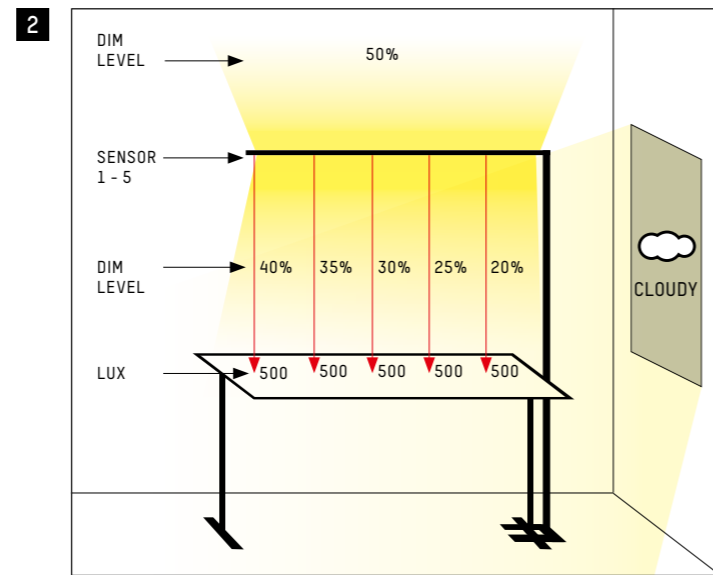
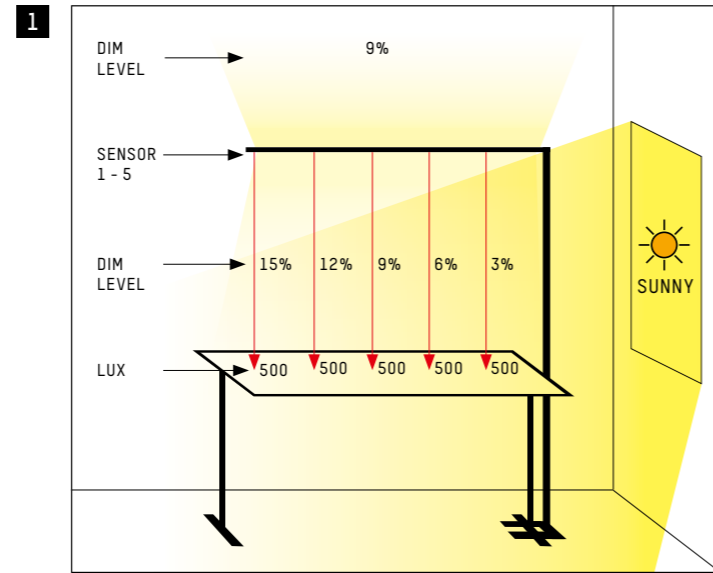

DIM 2 DISTANCE

Doch die Sensormatrix reagiert nicht nur auf Veränderungen der externen Lichtverhältnisse – sie erfasst auch Bewegungen der Tischhöhe und passt die Dim-Level entsprechend an. (siehe Bild 1) Diese Funktion ist besonders hilfreich bei der Nutzung von höhenverstellbaren Tischen, die sowohl in sitzender als auch in stehender Position verwendet werden können. Egal, ob der Tisch nach oben gefahren wird, um im Stehen zu arbeiten, oder nach unten, um bequem im Sitzen zu agieren, die Sensoren registrieren jede Bewegung präzise. Dies stellt sicher, dass die Beleuchtungsstärke stets optimal an die jeweilige Arbeitshöhe angepasst wird. Die intelligente Regelung der Lichtintensität sorgt dafür, dass eine eingestellte Beleuchtungsstärke von z.B. 500 Lux und eine perfekte Ausleuchtung des Arbeitsplatzes unabhängig von der Tischhöhe aufrechterhalten werden. (siehe Bild 2)

But the sensor matrix not only reacts to changes in external lighting conditions – it also detects movements in desk height and adjusts the dim levels accordingly. (see image 1) This function is particularly helpful when using height-adjustable desks, which can be used in both sitting and standing positions. Whether the desk is moved upwards to work standing up or downwards to work comfortably while sitting, the sensors accurately register every movement. This ensures that the lighting intensity is always optimally adapted to the respective working height. The intelligent control of light intensity ensures that a set lighting level of, e.g., 500 lux, and perfect illumination of the workspace are maintained regardless of the desk height. (see image 2)

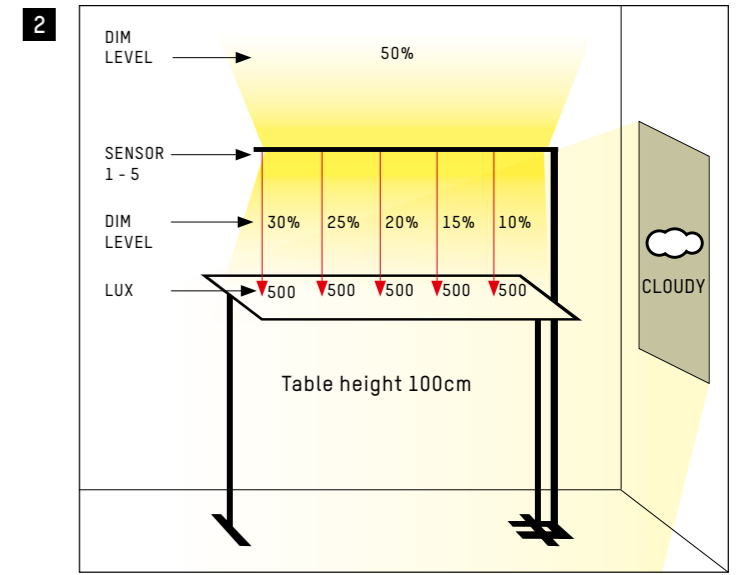
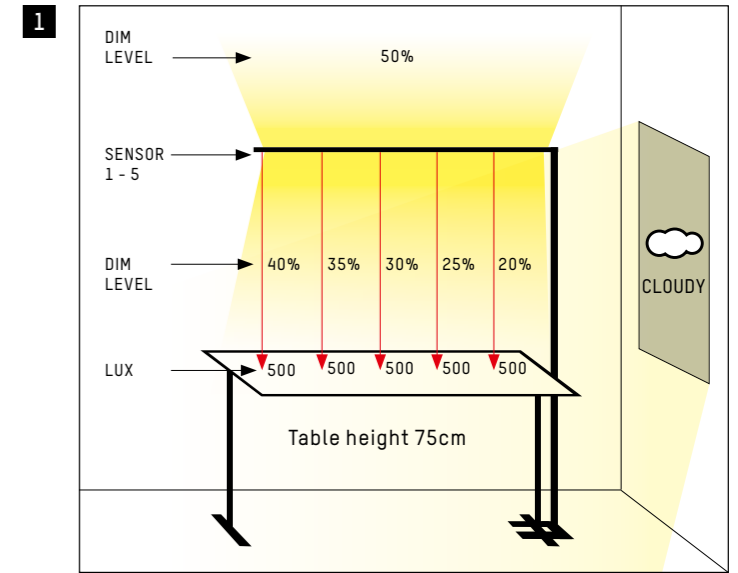

LENS 2 MATRIX TECHNOLOGY

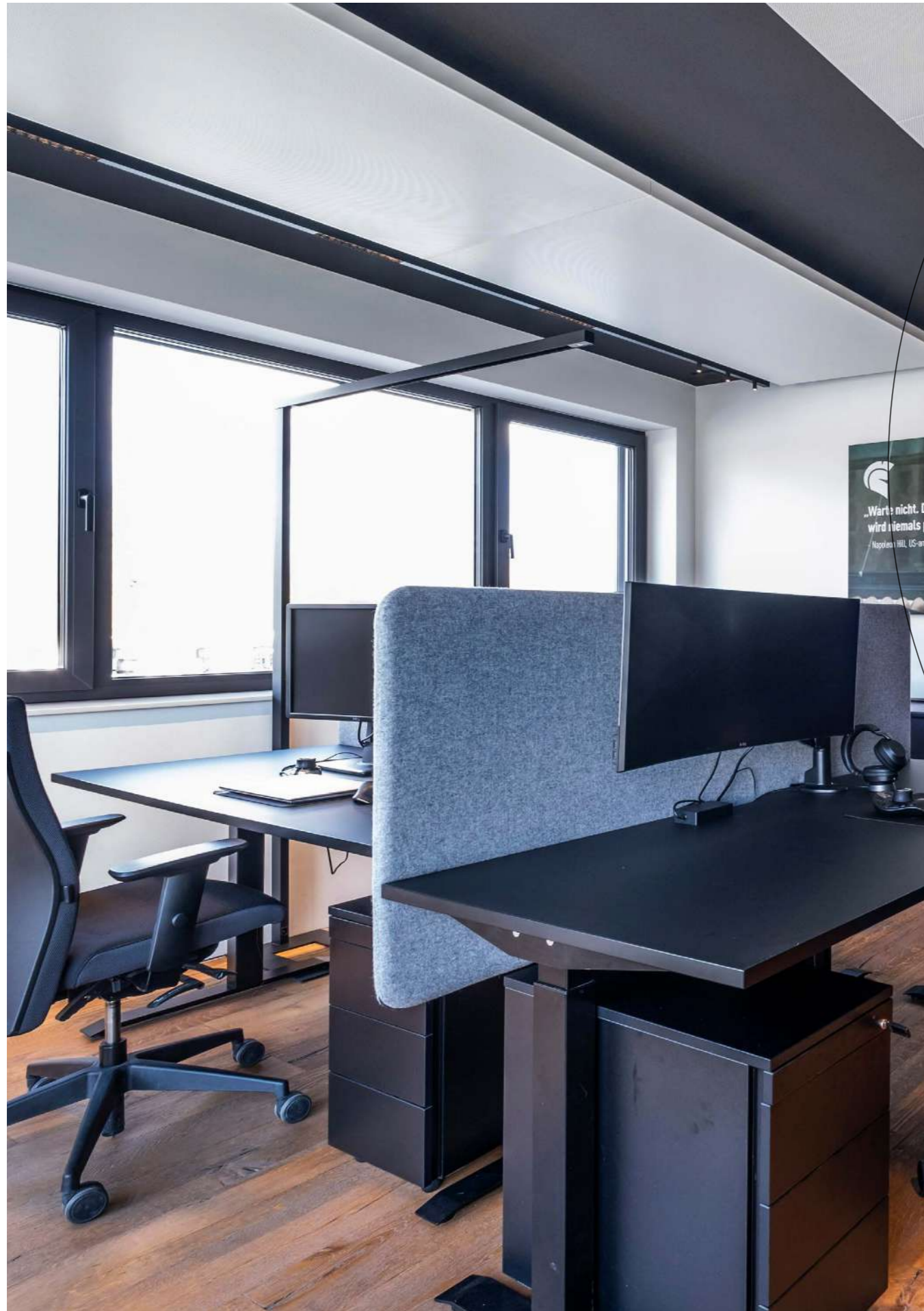

Kortmann Beton, Schüttdorf, Germany, Photo: Arnt Haug

LENS 2 CONFIGURATOR

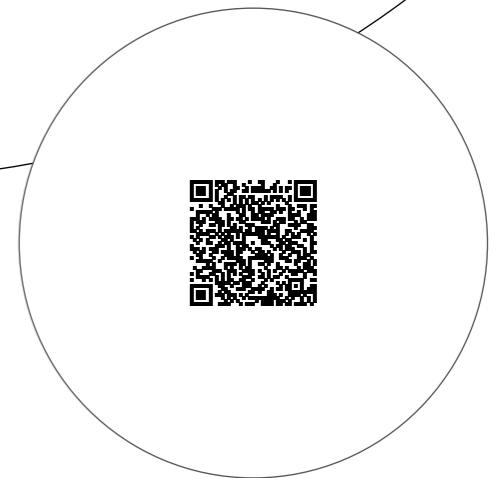
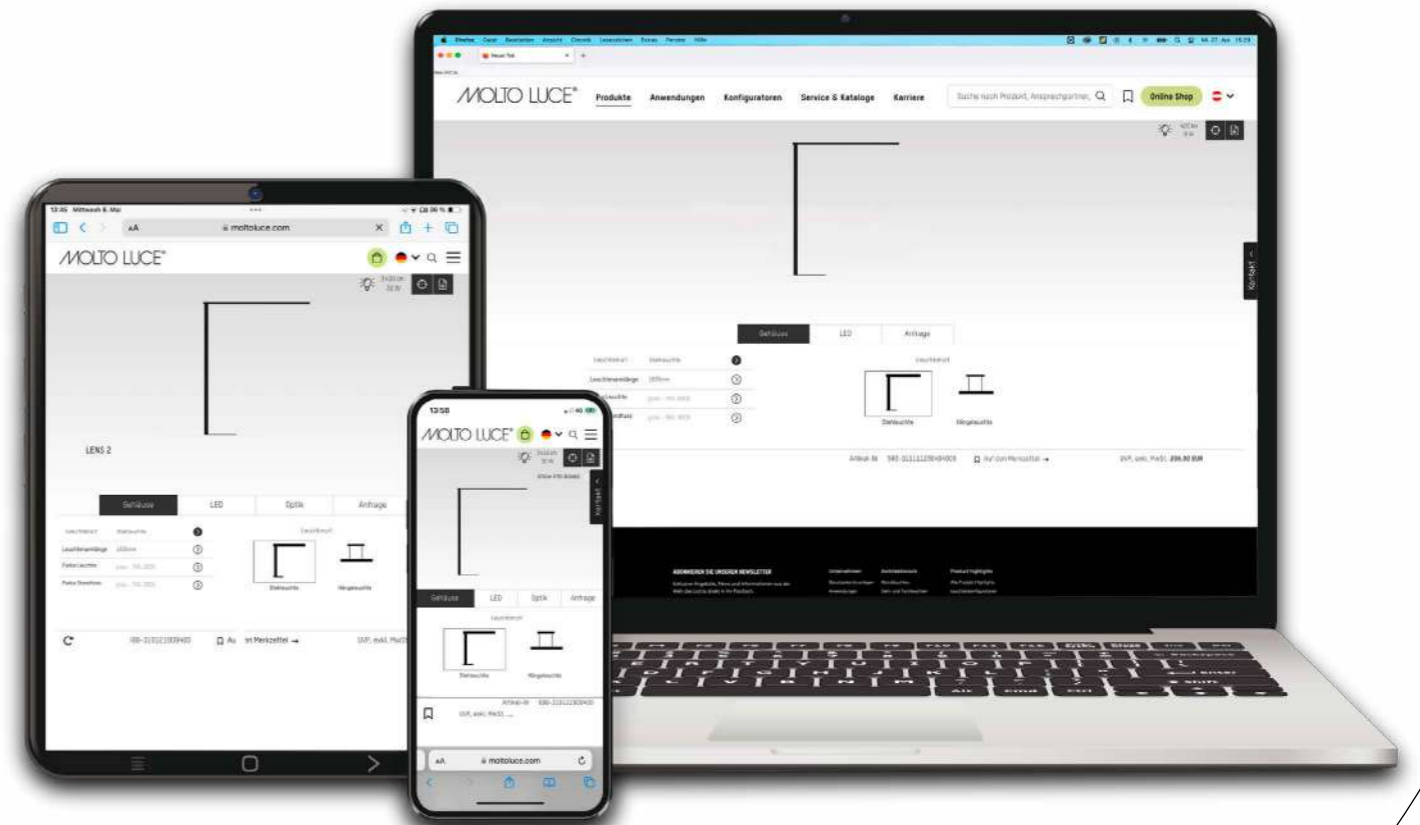



CONCEPT



Gusswerk, Salzburg, Austria, Photo: Joachim Rauch

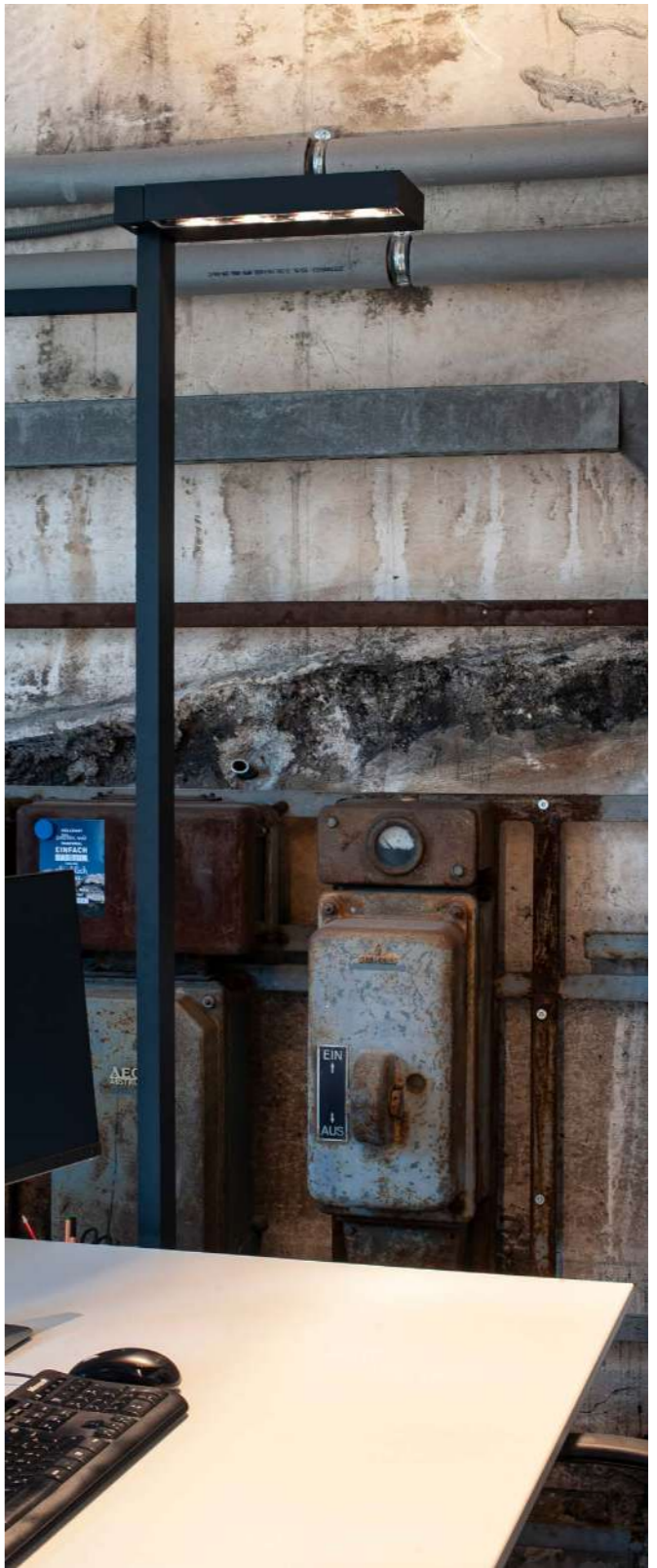

Elements, Gusswerk, Salzburg, Austria, Photo: Joachim Rauch

CONCEPT



Molto Luce, Weißkirchen, Austria
Photo: Joachim Rauch

THE NEXT GENERATION OF OFFICE LUMINAIRES

CONCEPT ist die erste auf dem Markt erhältliche Büroleuchte, welche stirnseitig angebracht wird und ohne Überhang den kompletten Arbeitsplatz normkonform (EN 12464-1) und mit höchster Homogenität ausleuchtet. Die minimalistisch anmutende Leuchtenserie wurde speziell für die hohen Anforderungen einer effizienten Lichtstimmung moderner Einzel- sowie Doppelarbeitsplätze entwickelt. Durch die separate Steuerung lässt sich nur jener Bereich ausleuchten, welcher gerade benötigt wird und ermöglicht so eine besonders nachhaltige und energiesparende Beleuchtungslösung.

CONCEPT is the first office luminaire available on the market which is attached on the front side and still offers standard-compliant illumination (EN 12464-1) of the complete workstation with highest homogeneity without overhang. The luminaire series with minimalist appearance was developed especially for the high requirements on efficient light atmosphere of modern single and double workstations. The separate control makes it possible to illuminate only required areas with an especially sustainable and energy-saving illumination as a result.

Design: INHOUSE

VARIATIONS



SINGLE & DOUBLE STAND LUMINAIRE
DIRECT / INDIRECT BEAM

LED COLOURS



3000K 4000K

CORE COLOURS



white black

SPECIALS



minimum glare / UGR<16



place frontside to the workstation for left, right and double work stations



Private residence, Austria, Photo: Joachim Rauch

CONCEPT F

CONCEPT LEFT F / CONCEPT RIGHT F

IP20

220-240V AC 50/60Hz CRI>80 Design: INHOUSE

LED Stehleuchte aus Aluminium · Oberfläche pulverbeschichtet · Freiformflächenreflektor für Einzelarbeitsplatz · Platzierung links bzw. rechts von Arbeitsplatz · mit Tageslichtsensor, Bewegungsmelder und Schwarm-funktion

LED floor lamp in aluminium · surface powder-coated · free-form surface reflector for single workstation · placement left or right of workstation · with daylight control, motion detector and wireless swarm network-function

Piantana led ad ingombro ridotto in alluminio · superficie verniciata a polveri · riflettore a forma libera per postazione di lavoro singola · posizionamento sinistro o destro sul luogo di lavoro · sensore di movimento, rilevatore di luminosità e funzione di rete wireless

Lampadaire LED en aluminium · surface lacquée en poudre · réflecteur uniforme pour poste de travail individuel · positionnement à gauche ou à droite du plan de travail · Détecteur de mouvement, capteur de lumière et fonction réseau sans fil

CONCEPT LEFT F

SYS 70W	UGR<16	LM
723-0011101WWXXY		7400 - 7710
Links am Schreibtisch platzieren Place left of workstation		

CONCEPT RIGHT F

SYS 70W	UGR<16	LM
723-0011201WWXXY		7400 - 7710
Rechts am Schreibtisch platzieren Place right of workstation		

PUSH BUTTON MOTION SWARM

646-000040000050		ON / OFF & Dimm
646-000040000060		ON / OFF & Dimm
Optionaler radio push-button Optional radio push-button		

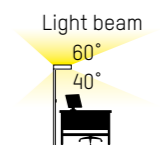
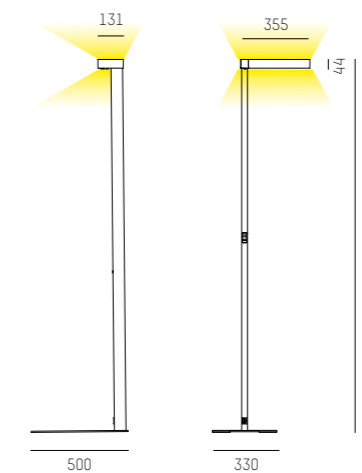
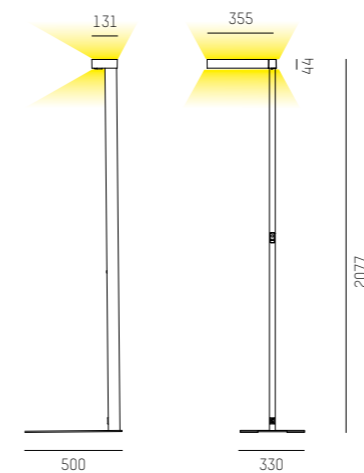
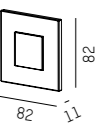

COMPLETE CODE		
WW = LICHTFARBE / LIGHT COLOUR	XX = FARBE / COLOUR	Y = DIMMBAR / DIMMABLE
LED 3000K = 19	white = 55	switchable = 0
LED 4000K = 14	black = 66	motion swarm = m (without foil button)
		push-button dim = t
		motion daylight = k



Molto Luce, Weißkirchen, Austria, Photo: Joachim Rauch

CONCEPT F

CONCEPT DOUBLE F

220-240V AC 50/60Hz CRI>80 Design: INHOUSE

IP20

LED Stehleuchte aus Aluminium · Oberfläche pulverbeschichtet · Freiformflächenreflektor für Doppelarbeitsplatz · mit Tageslichtsensor, Bewegungsmelder und Schwarm-funktion

LED floor lamp in aluminium · surface powder-coated · free-form surface reflector for double workstation · with daylight control, motion detector and wireless swarm network-function

Piantana led ad ingombro ridotto in alluminio · superficie verniciata a polveri · riflettore a forma libera per postazione di lavoro doppia · sensore di movimento, rilevatore di luminosità e funzione di rete wireless

Lampadaire LED en aluminium · surface lacquée en poudre · réflecteur uniforme pour poste de travail individuel · réflecteur uniforme pour poste de travail double · Détecteur de mouvement, capteur de lumière et fonction réseau sans fil

CONCEPT DOUBLE F

SYS 140W	UGR<16	LM
723-0011303 WWXXY		14800 - 15420
In der Mitte von 2 Schreibtischen platzieren Place in center of two workstations		

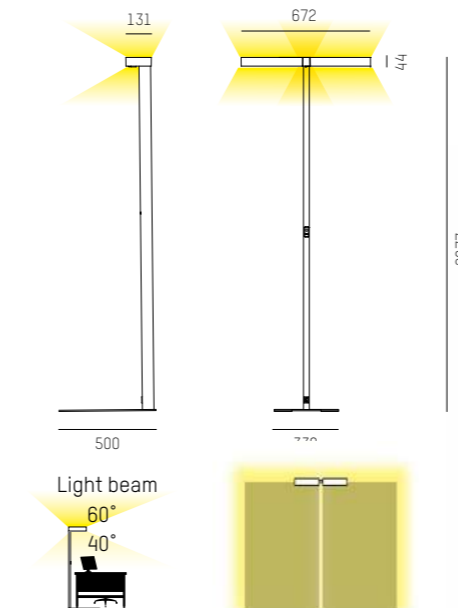

PUSH BUTTON MOTION SWARM

646-000040000050		ON / OFF & Dimm
646-000040000060		ON / OFF & Dimm

Optionaler radio push-button
Optional radio push-button

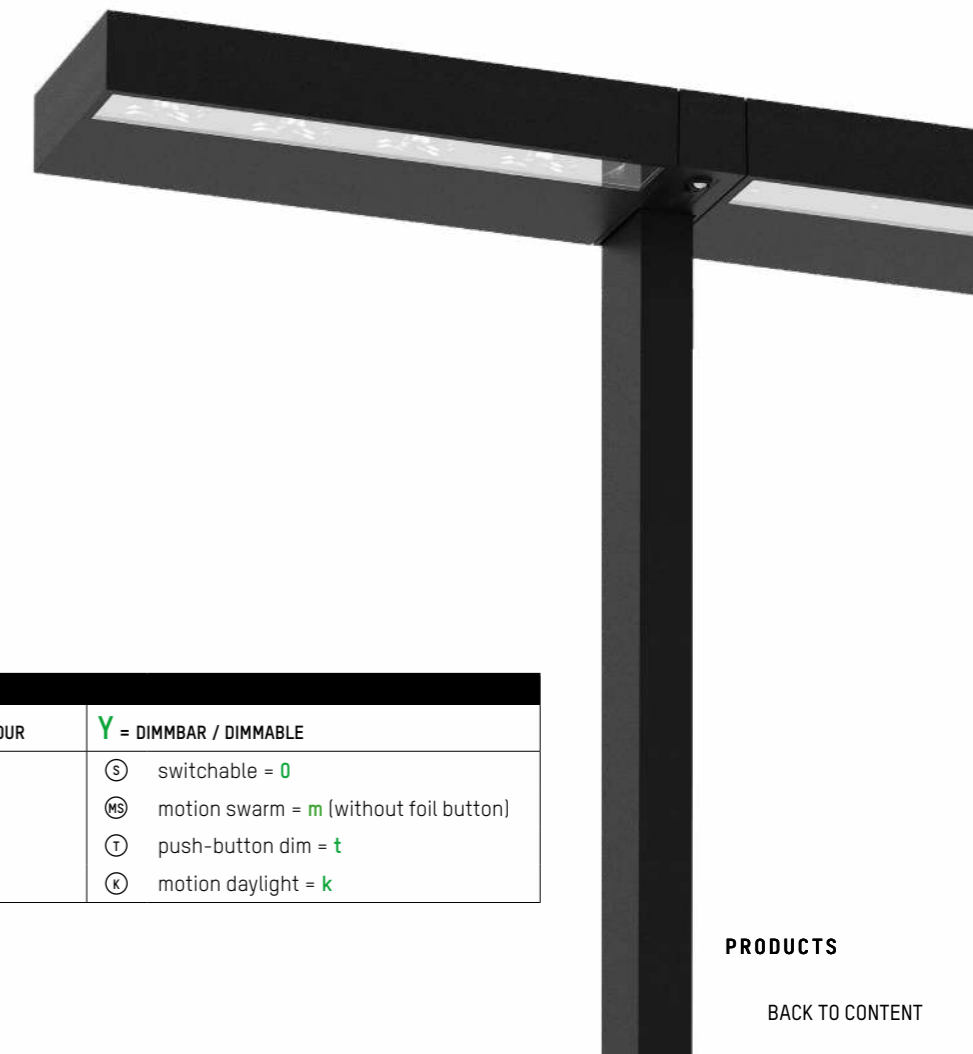
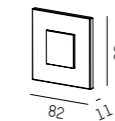

COMPLETE CODE		
WW = LICHTFARBE / LIGHT COLOUR	XX = FARBE / COLOUR	Y = DIMMBAR / DIMMABLE
LED 3000K = 19	white = 55	switchable = 0
LED 4000K = 14	black = 66	motion swarm = m (without foil button)
		push-button dim = t
		motion daylight = k

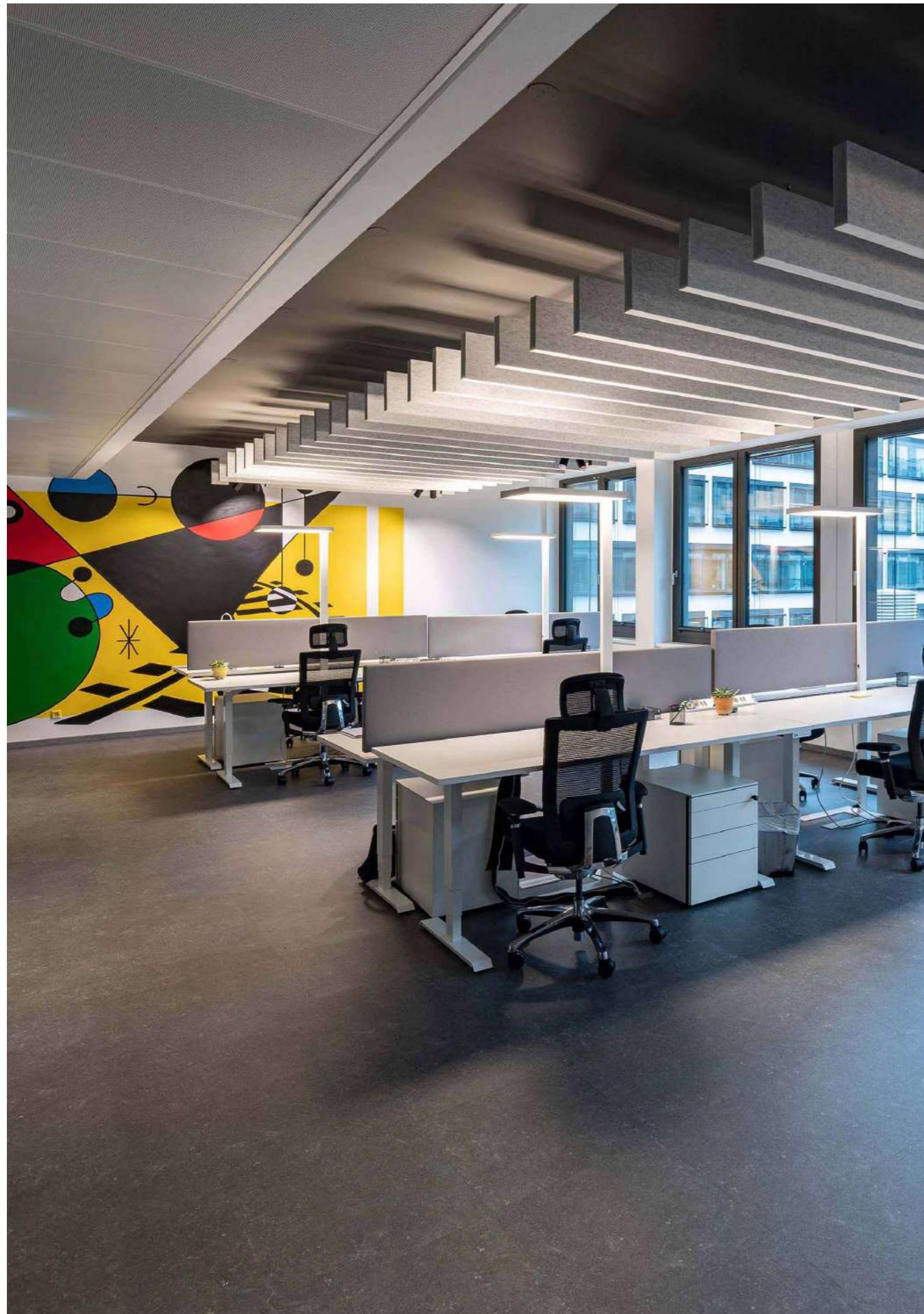

TMC, Vienna, Austria, Photo: Joachim Rauch

SYSTEM 01

SYSTEM 01.1 F

220-240V AC 50/60Hz CRI>80 Design: INHOUSE

IP20

LED Stehleuchte direkt-/ indirekt strahlend · hochtransparente Mikroprismen direkt, klare Abdeckung indirekt · versionspezifisch: Taster dimmbar, Bewegungsmelder und Tageslichtsensor oder als Bewegungsmelder mit Tageslichtsensor und wireless Schwarm Netzwerkfunktion

LED floor lamp with direct and indirect beam · highly transparent microprismatic diffuser direct and clear cover indirect · versions with dimmable switch, motion detector and daylight control or motion detector and daylight control and wireless swarm network-function

Piantana a LED con luce diretta ed indiretta · diretta con diffusore microprismatico ad alta trasparenza, indiretta con copertura trasparente · dimmerabile con pulsante, Rivelatore di movimento e controllo luce del giorno oppure, rivelatore di movimento e controllo luce del giorno e wireless funzione di rete

Lampadaire LED avec émission directe et indirecte · diffuseur microprismatique haute qualité, indirect diffuseur transparent · dimmable avec interrupteur, détecteur de mouvement et contrôle lumière de jour ou détecteur de mouvement et contrôle lumière de jour et wireless fonction du réseau

SYS 93W	UGR<19	LM
697-0606130WWXXY		13640 - 14290

PUSH BUTTON MOTION SWARM	
646-000040000050	ON / OFF & Dimm
646-000040000060	ON / OFF & Dimm
Optionaler radio push-button	
Optional radio push-button	

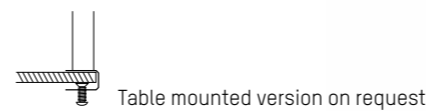
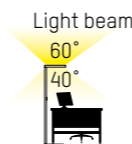
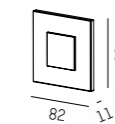
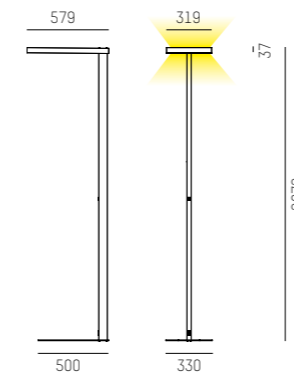

COMPLETE CODE			
G = PUSH BUTTON	WW = LIGHT COLOUR	XX = COLOUR	Y = DIMMABLE
push button = 0	LED 3000K = 19	grey = 04	switchable = 0
foil button = 1	LED 4000K = 14	white = 05	motion swarm = m (without foil or push button)
motion swarm = 0		black = 06	push-button dim = t
			motion daylight = k

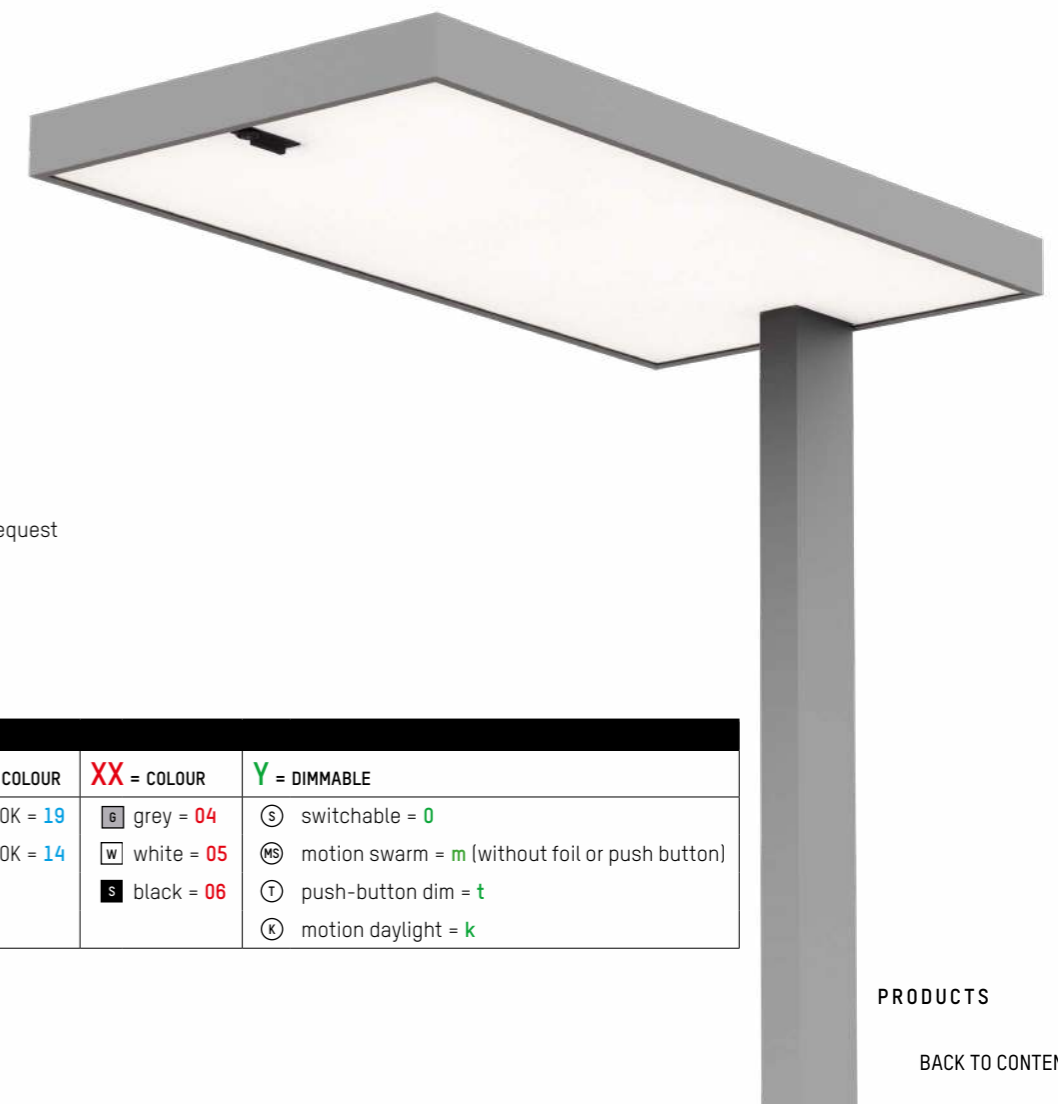



Molto Luce, Wels, Austria, Photo: Joachim Rauch

SYSTEM 02

SYSTEM 02.1 F

220-240V AC 50/60Hz CRI>80 Design: INHOUSE

IP20

LED Stehleuchte direkt-/ indirekt strahlend · hochtransparente Mikroprismen direkt, klare Abdeckung indirekt · versionspezifisch: Taster dimmbar, Bewegungsmelder und Tageslichtsensor oder als Bewegungsmelder mit Tageslichtsensor und wireless Schwarm Netzwerkfunktion

LED floor lamp with direct and indirect beam · highly transparent microprismatic diffuser direct and clear cover indirect · versions with dimmable switch, motion detector and daylight control or motion detector and daylight control and wireless swarm network-function

Piantana a LED con luce diretta ed indiretta · diretta con diffusore microprismatico ad alta trasparenza, indiretta con copertura trasparente · dimmerabile con pulsante, Rivelatore di movimento e controllo luce del giorno oppure, rivelatore di movimento e controllo luce del giorno e wireless funzione di rete

Lampadaire LED avec émission directe et indirecte · diffuseur microprismatique haute qualité, indirect diffuseur transparent · dimmable avec interrupteur, détecteur de mouvement et contrôle lumière de jour ou détecteur de mouvement et contrôle lumière de jour et wireless fonction du réseau

SYS 93W	UGR<19	LM
725-0406130 WWXXY		13640 - 14290

PUSH BUTTON MOTION SWARM		
646-000040000050		ON / OFF & Dimm
646-000040000060		ON / OFF & Dimm
Optionaler radio push-button		
Optional radio push-button		

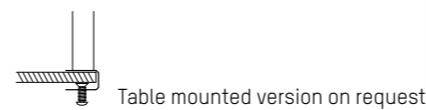
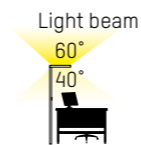
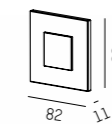
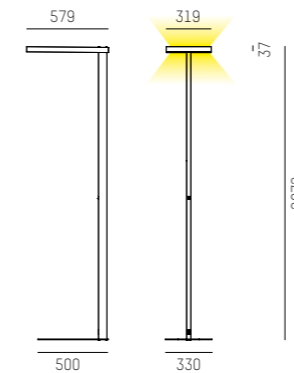

COMPLETE CODE			
G = PUSH BUTTON	WW = LIGHT COLOUR	XX = COLOUR	Y = DIMMABLE
push button = 0	LED 3000K = 19	white = 05	switchable = 0
foil button = 1	LED 4000K = 14	black = 06	motion swarm = m (without foil or push button)
motion swarm = 0		alu anodized = 08	push-button dim = t
			motion daylight = k



LON

MORE VARIATIONS. MORE FLEXIBILITY.

LON bietet eine Vielfalt an Optionen, um jeden Raum stilvoll und funktional zu beleuchten. Diese Leuchte ist in den Varianten direkt oder direkt/indirekt erhältlich, sodass die Lichtverteilung ganz nach Wunsch gestaltet werden kann. Egal ob als Ring oder Hexagon, jede Form setzt ein einzigartiges optisches Highlight und ermöglicht kreative Statements in der Raumgestaltung. LON kann außerdem mit einem Acoustics-Einsatz versehen werden, um positiv zur Raumakustik beizutragen und eine angenehme Atmosphäre zu schaffen. Zur Auswahl stehen die klassischen Farben Schwarz, Weiß und Grau oder farbliche Akzente mit den Creative Colours. LON ist in drei verschiedenen Farbtemperaturen erhältlich: 2700K, 3000K und 4000K. Mit ihrem modernen Design und den vielseitigen Einsatzmöglichkeiten wird LON zum optischen Highlight jedes Raumes.

LON offers a variety of options to illuminate any room in a stylish and functional way. It is available in direct or direct/indirect versions so that the light distribution can be customised as desired. Whether as a ring or hexagon, each shape creates a unique visual highlight and enables creative statements in interior design. LON can also be fitted with an Acoustics insert to make a positive contribution to room acoustics and create a pleasant atmosphere. The classic colours black, white and grey or colourful accents with our Creative Colours are available. LON is available in three different colour temperatures: 2700K, 3000K and 4000K. With its modern design and versatile application possibilities LON becomes the visual highlight of any room.

Design: INHOUSE

VARIATIONS

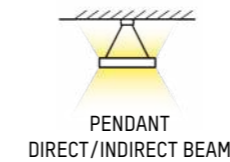
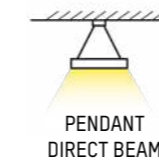

FORM & SIZES



circle

Ø 1000mm / 2540-5080lm
Ø 1500mm / 3810-7620lm



hexagon

Ø 1000mm / 2540-5080lm
Ø 1500mm / 3810-7620lm

CORE COLOURS



white



black

CREATIVE COLOURS



copper



berlin blue



gold



berry blue



merlot



terra



highland green



creme



sepia



anthrazit



forest



bronze

LED COLOURS



2700K



3000K

ACOUSTIC COLOURS



white mottled

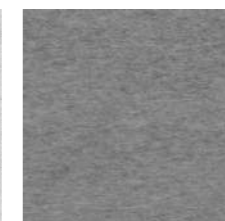

grey mottled



antracite mottled



Molto Luce fair stand, Light & Building Frankfurt, Germany, Photo: Joachim Rauch

LON HEXAGON

LON HEXAGON PD / PDI

220-240V AC 50/60Hz Design: INHOUSE

IP20

Hexagonale LED Pendelleuchte aus Aluminiumprofil · Oberfläche pulverbeschichtet · Opale Abdeckung · Schaltbar oder dimmbar
 Hexagonal LED pendant luminaire made of aluminium profile · surface powder-coated · opal cover · switchable or dimmable
 Apparecchio a sospensione LED esagonale in profilo di alluminio · superficie verniciata a polvere · Coperchio opale · on/off o dimmerabile
 Suspension LED hexagonal en profilé d'aluminium · surface thermolaquée · diffuseur opale · on/off ou dimmable

LON HEXAGON 1000 PD

CODE	SYS W	LUMEN
224-02110CCWWXXXXAAY	35	2540



LON HEXAGON 1000 PDI

CODE	SYS W	LUMEN
224-02210CCWWXXXXAAY	70	5080

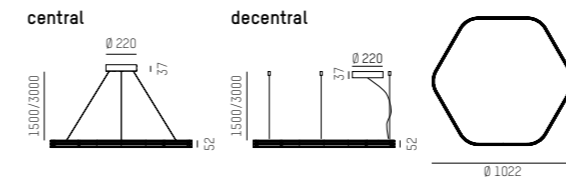

LON HEXAGON 1500 PD

CODE	SYS W	LUMEN
224-02120CCWWXXXXAAY	52	3810



LON HEXAGON 1500 PDI

CODE	SYS W	LUMEN
224-02220CCWWXXXXAAY	103	7620

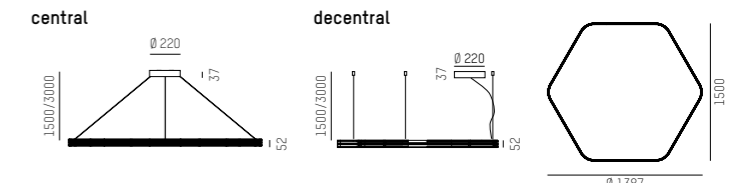

ACOUSTIC PANEL HEXAGON 1000

CODE	SYS W	LUMEN
224-02010CC000000AA0	0	0

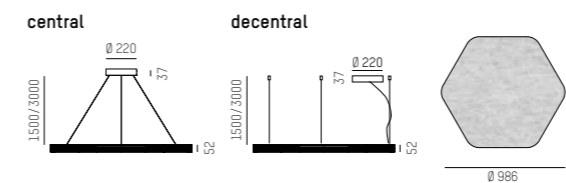

ACOUSTIC PANEL HEXAGON 1500

CODE	SYS W	LUMEN
224-02010CC000000AA0	0	0

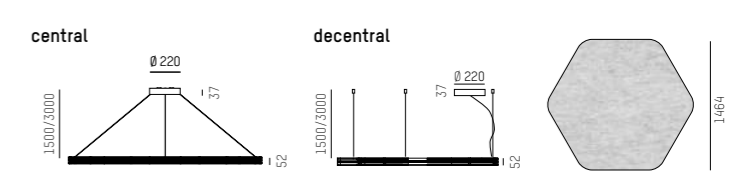

COMPLETE CODE				
CC = CANOPY / SUSPENSION	W = LIGHT COLOUR	XXXX = COLOUR LUMINAIRE	AA = COLOUR ACOUSTIC	Y = DIMMABLE
central / 1500mm = 11 central / 3000mm = 12 decentral / 1500mm = 21 decentral / 3000mm = 22	W2 LED 2700K = 23 CRI>90 W3 LED 3000K = 29 CRI>90	W white = 0505 S black = 0606	without acoustic = 00 BM grey mottled = 94 WM white mottled = 95 AM antracithe mottled = 99	S switchable = 0 D DALI dim = d C CASAMBI dim = c



LON ROUND

LON ROUND PD / PDI

220-240V AC 50/60Hz Design: INHOUSE

IP20

Runde LED Pendelleuchte aus Aluminiumprofil · Oberfläche pulverbeschichtet · Opale Abdeckung · Schaltbar oder dimmbar
 Round LED pendant luminaire made of aluminium profile · surface powder-coated · opal cover · switchable or dimmable
 Apparecchio a sospensione LED rotonda in profilo di alluminio · superficie verniciata a polvere · Coperchio opale · on/off o dimmerabile
 Suspension LED ronde en profilé d'aluminium · surface thermolaquée · diffuseur opale · on/off ou dimmable

LON ROUND 1000 PD

CODE	SYS W	LUMEN
224-01110S0WVXXXXAAY	35	2540



LON ROUND 1000 PDI

CODE	SYS W	LUMEN
224-01210S0WVXXXXAAY	70	5080

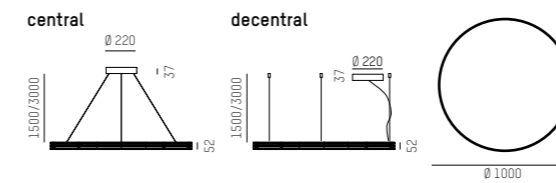

LON ROUND 1500 PD

CODE	SYS W	LUMEN
224-01120S0WVXXXXAAY	52	3810



LON ROUND 1500 PDI

CODE	SYS W	LUMEN
224-01220S0WVXXXXAAY	103	7620

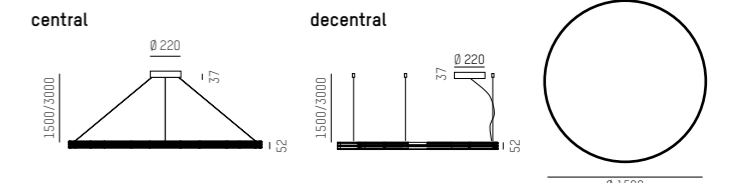

ACOUSTIC PANEL ROUND 1000

CODE	SYS W	LUMEN
224-01010CC000000AA0	0	0

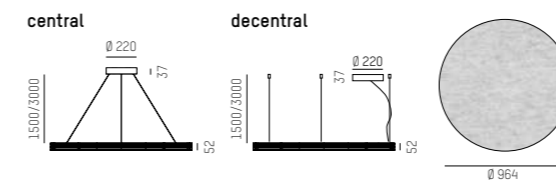

ACOUSTIC PANEL ROUND 1500

CODE	SYS W	LUMEN
224-01020CC000000AA0	0	0

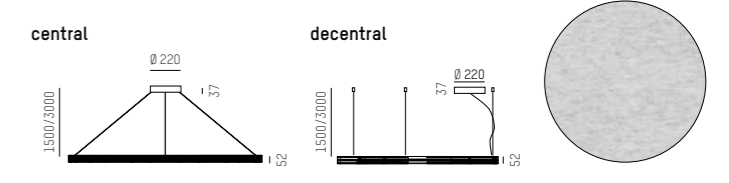

COMPLETE CODE				
CC = CANOPY / SUSPENSION	W = LIGHT COLOUR	XXXX = COLOUR LUMINAIRE	AA = COLOUR ACOUSTIC	Y = DIMMABLE
central / 1500mm = 11 central / 3000mm = 12 decentral / 1500mm = 21 decentral / 3000mm = 22	W2 LED 2700K = 23 CRI>90 W3 LED 3000K = 29 CRI>90	W white = 0505 S black = 0606	without acoustic = 00 BM grey mottled = 94 WM white mottled = 95 AM antracithe mottled = 99	S switchable = 0 D DALI dim = d C CASAMBI dim = c



ACOUSTIC



more information

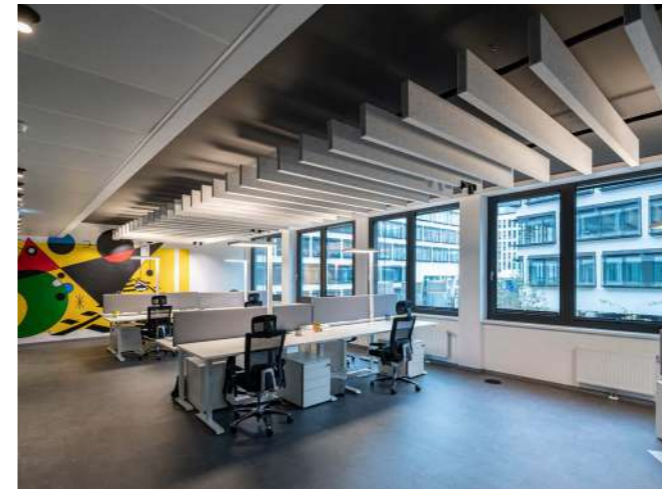

TMC Vienna, Austria, Planing & Realisation: Ben Elmecker, Photo: Joachim Rauch



Molto Luce, Weißkirchen, Austria, Photo: Joachim Rauch



Wimberger Haus, Lasberg, Austria, Planing & Realisation: Ben Elmecker
Photo: Joachim Rauch



Light & Building 2024, Frankfurt, Germany, Photo: Joachim Rauch



Office Ben Elmecker, Rainbach, Austria, Photo: Joachim Rauch



TMC Vienna, Austria, Planing & Realisation: Ben Elmecker, Photo: Joachim Rauch



Neom Free City, Freistadt, Austria
 Planing & Realisation: Ben Elmecker
 Photo: Joachim Rauch

BAFFELS

SILENT MOOD OF LIGHT

Reduzierte akustische Belastungen, steigern Wohlbefinden, Konzentration sowie Leistungsfähigkeit und der Stresslevel sinkt nachweislich. Speziell in Vortrags- und Hörsälen, Theatern, Seminar-, Klassen-, und Büroräumen spielt die Akustik eine wesentliche Rolle. Optimiert werden kann das akustische Verhalten durch das Platzieren schallabsorbierender Elemente im Raum.

Akustik Baffeln mit Lichteinsätzen

Unsere Baffeln aus thermisch verfestigtem Vliesstoff verringern durch eine möglichst große und diffus reflektierende Fläche die Lärmbelastung und bestehen zudem aus 60% recycelten PET-Flaschen. Die Abhängehaken, welche absolut flächenbündig in der Baffel sitzen, werden direkt mit der 3-Phasen Stromschiene verbunden und sind ohne weiteren Montageaufwand variabel entlang der Stromschiene platzierbar. Beleuchtungselemente wie MOVA oder LOG 50 sind in der Stirnkante montiert und erzeugen neben einer hervorragenden Raumakustik die passende Lichtstimmung.

A reduced acoustic impact enhances the well-being, concentration and the performance and has proven to reduce stress. Especially in auditoriums, theatres, seminar and class rooms as well as in offices the acoustic plays a major role. The acoustic behaviour can be optimized by sound-absorbing elements in the room.

Acoustic baffles with light inserts

With their large and diffuse reflecting surface, our baffles made of thermally bonded non-woven fabric reduce the noise impact. On top of that, they are made of 60% of recycled PET bottles. The suspension hooks, fully flush in the baffle, are directly attached to the 3-phase track system and can be placed variably along the track system without the need to reassemble it. Illumination elements like MOVA or LOG50 are mounted on the front edge and create not only excellent room acoustics, but also the right lighting atmosphere.

Design: INHOUSE

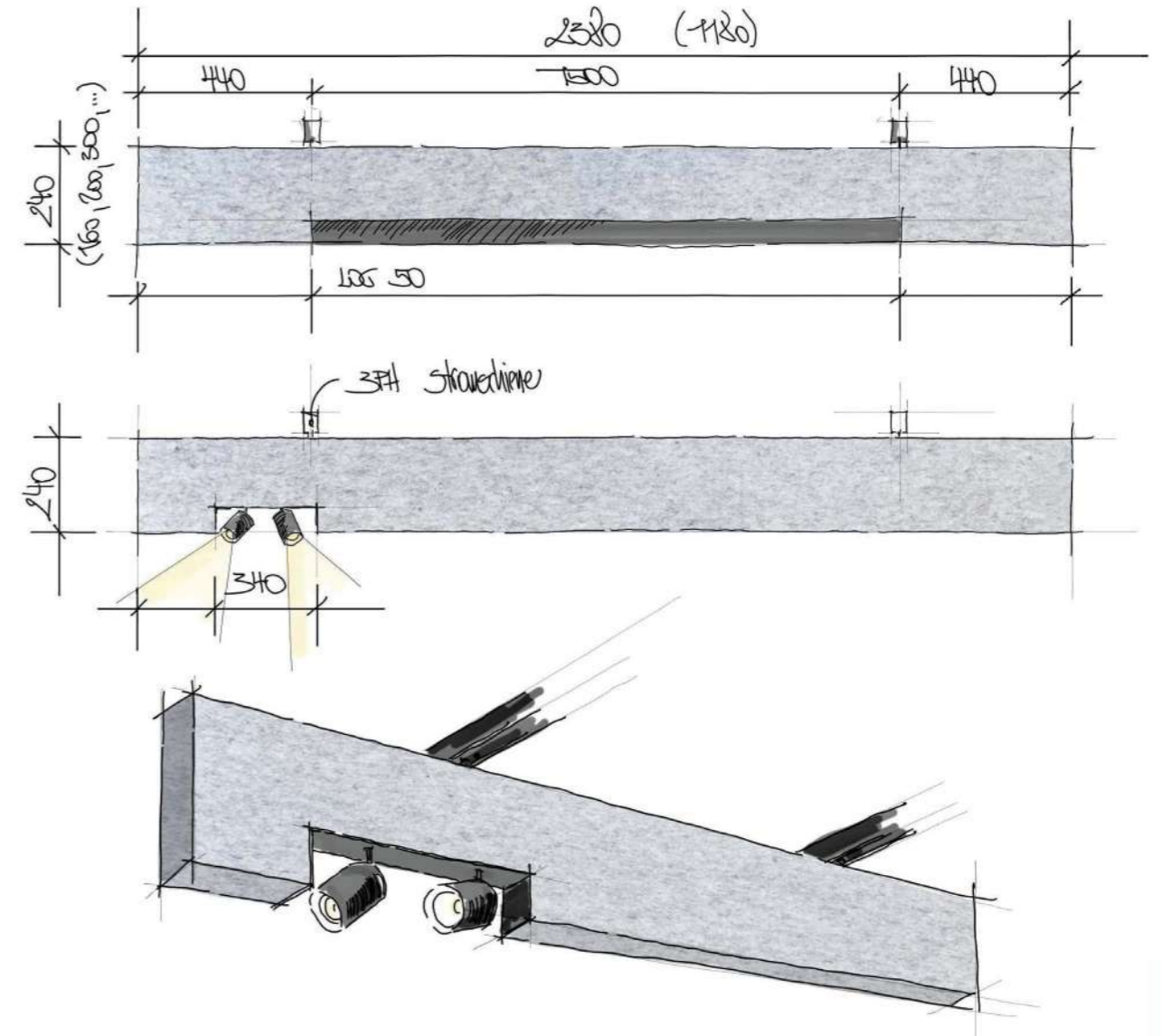

Design draft

 ben elmecker

BAFFLES

BAFFEL STANDARD BAFFLE STANDARD	LÄNGE LENGHT
785-00110000009X0	2380mm

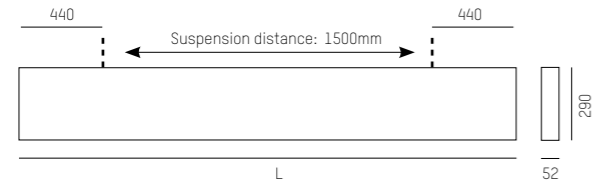

BAFFEL FÜR LOG 50 846 BAFFLE FOR LOG 50 846	LÄNGE LENGHT
785-00210000009X0	2380mm

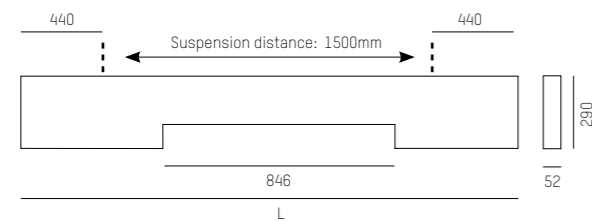

BAFFEL FÜR LOG 50 1687 BAFFLE FOR LOG 50 1687	LÄNGE LENGHT
785-00310000009X0	2380mm

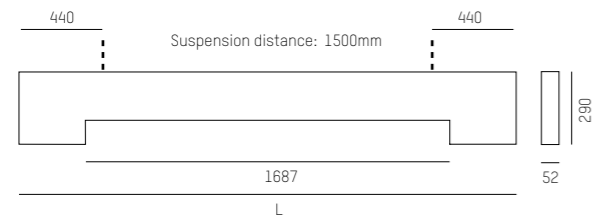

BAFFEL FÜR MOVA BAFFLE FOR MOVA	LÄNGE LENGHT
785-00410000009X0	2380mm

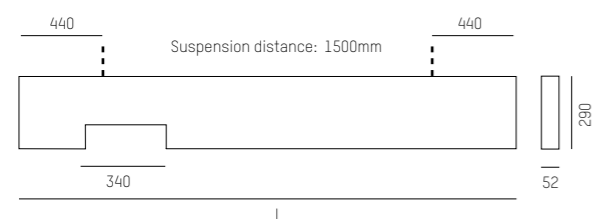

COMPLETE CODE	
X = BAFFEL COLOUR	
grey mottled = 4	white mottled = 5



BAFFELS

ACHTUNG: Lichteinsätze, Abhängungen und Einspeisungen separat ordern
ATTENTION: Order light inserts, suspensions and power feed separately

LIGHT INSERTS

LICHTEINSATZ LOG 50 LIGHT INSERT LOG 50	LÄNGE LENGTH
Configure	846



Configure

LICHTEINSATZ LOG 50 LIGHT INSERT LOG 50	LÄNGE LENGTH
Configure	1687



Configure

LICHTEINSATZ MOVA LIGHT INSERT MOVA	SYS W SYS W	LUMEN LUMEN
785-049510RR4906Y	2 x 24W	2 x 1510

LED 3000K PREMIUM CRI>90
Inkl. Einspeisung
incl. power feed



COMPLETE CODE	
RR = BEAM ANGLE	Y = DIMMABLE
medium 24° = 12	switchable = 0
flood 40° = 13	DALI dim = d

POWER FEED FOR LOG 50 INSERTS

EINSPEISUNG FÜR LOG 50 LICHTEINSATZ POWER FEED FOR LOG 50 LIGHT INSERT	KABEL CABLE
---	----------------

785-0910000000060 3 x 0,75mm
785-091000000006d 5 x 0,75mm
Kabel transparent, L: 1750mm +3-Phasen Adapter
Cable transparent, L: 1750mm +3-phase Adapter

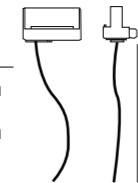

SUSPENSIONS

ABHÄNGUNG FÜR BAFFELELEMENTE SUSPENSION FOR BAFFLES ELEMENTS	SEIL ROPE
---	--------------

785-0900000000060
wird 2 x pro Baffle benötigt
required 2 x per baffle

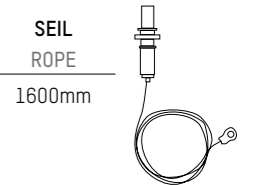

ADAPTER FÜR DEKOHAKEN ADAPTER FOR DECO HOOK	FARBE COLOUR
--	-----------------

208-19160143 W
208-19160142 S
208-19160141 G
zum einklippen in die Schiene, wird 2 x pro Baffle benötigt
to clip into rail, required 2 x per baffle



DEKOHAKEN DECO HOOK	FARBE COLOUR
------------------------	-----------------

208-19160111 G
Adapter separat ordern
order adapter separately





Salience Consulting, Skopje, Macedonia, Photo: Property One Design and Development

BOARD ROUND

BOARD ROUND

Design: INHOUSE

Aus akustisch wirksamen Material · BIDO Hängeleuchte separat konfigurieren
 Made of acoustically effective material, BIDO Pendant must be configured separately
 Realizzato in materiale fonoassorbente; Configurare separatamente la lampada a sospensione BIDO
 En matériau acoustiquement efficace; Configurer la lampe à suspendre BIDO séparément

BOARD ROUND 400

CODE	COLOUR
585-00504	grey mottled
585-00505	white mottled
585-00529	anthracite mottled

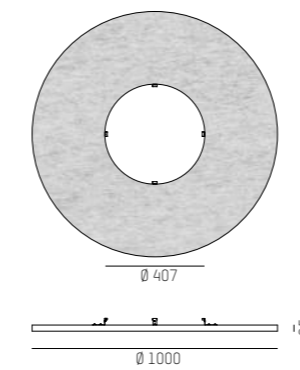

LICHTEINSATZ BIDO 400	Ø
LIGHT INSERT BIDO 400	Ø
Configure	400

BOARD ROUND 600

CODE	COLOUR
585-00604	grey mottled
585-00605	white mottled
585-00629	anthracite mottled

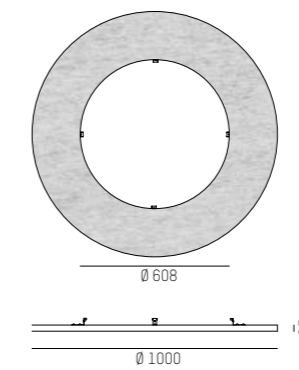

LICHTEINSATZ BIDO 600	Ø
LIGHT INSERT BIDO 600	Ø
Configure	600

ACOUSTIC PANEL BOARD ROUND 1000

CODE	COLOUR
585-00704	grey mottled
585-00705	white mottled
585-00709	anthracite mottled

Inkl. Abhängung / incl. suspension

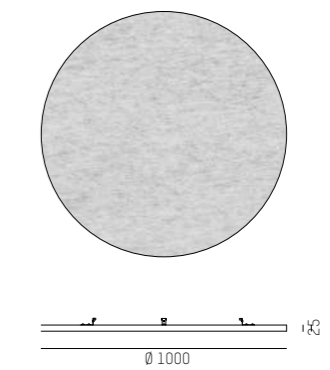

Configure



Configure



BOARD SQUARE

BOARD SQUARE

Design: INHOUSE

Aus akustisch wirksamen Material · LOG 50 Hängeleuchte separat konfigurieren

Made of acoustically effective material, LOG 50 Pendant must be configured separately

Realizzato in materiale fonoassorbente; Configurare separatamente la lampada a sospensione LOG 50

En matériau acoustiquement efficace; Configurer la lampe à suspendre LOG 50 séparément

BOARD SQUARE

CODE	COLOUR
585-00304	grey mottled
585-00325	white mottled
585-00329	anthracite mottled

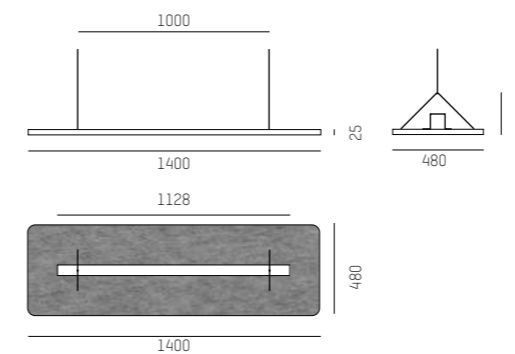

ACOUSTIC PANEL BOARD SQUARE

CODE	COLOUR
585-00404	grey mottled
585-00405	white mottled
585-00409	anthracite mottled

Inkl. Abhängung / incl. suspension

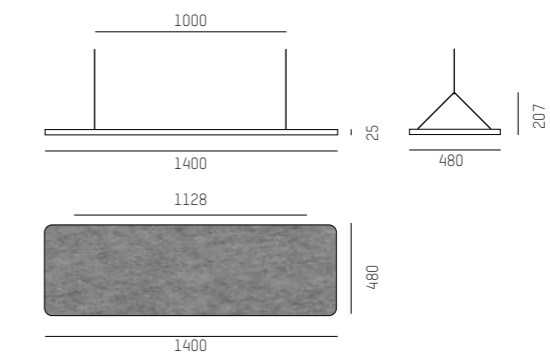

LICHTEINSATZ LOG 50	LÄNGE
LIGHT INSERT LOG 50	LENGTH
Configure	1126



Configure

INTERO

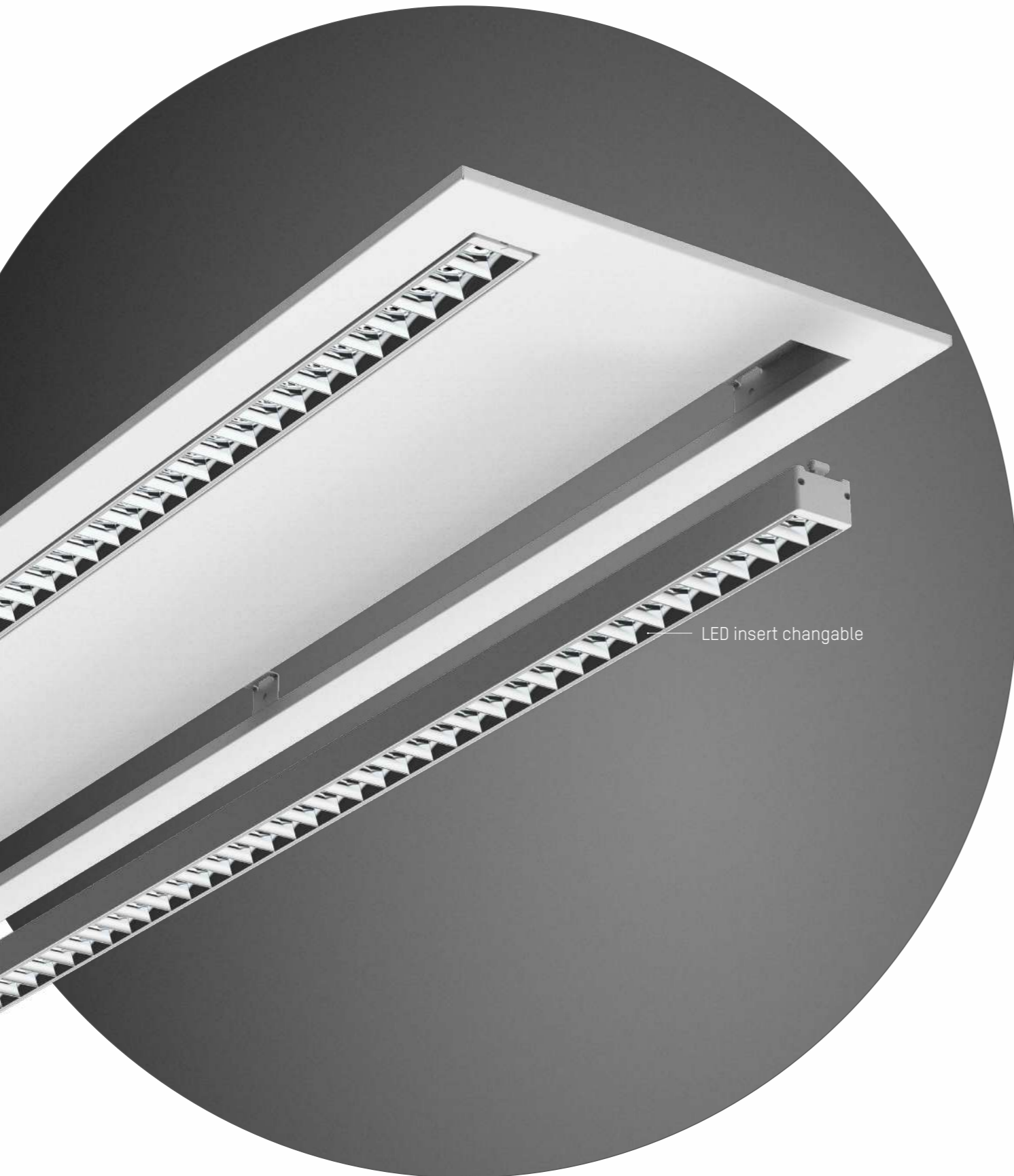

X-CHANGE TO ENERGY EFFICIENCY

INTERO ist unsere energieeffiziente Office-Leuchte, ausgestattet mit tauschbarem LED Leuchtmittel und Konverter. Diese rechteckige Einbauleuchte aus Stahlblech eignet sich unter anderem optimal für Rasterdecken. INTERO ist zudem in unseren Trendfarben Creative Colours für Ihr Projekt nach Wunsch individualisierbar.

INTERO is our energy-efficient office luminaire equipped with an interchangeable LED bulb and converter. This rectangular recessed luminaire made of steel plate is particularly suitable for louvred ceilings. INTERO can also be customised to your wishes with our trendy Creative Colours.

Design: INHOUSE

VARIATIONS

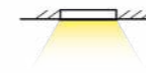

RECESSED

SIZES

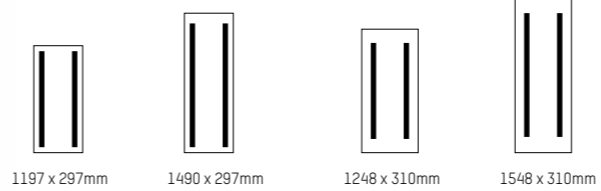

CORE COLOURS



white

CREATIVE COLOURS

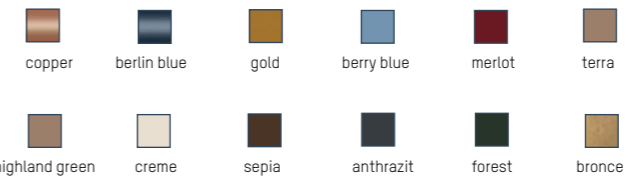

LED COLOURS

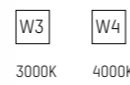

3000K 4000K

SPECIALS



LED insert & converter insert changable



INTERO R

INTERO ECO 600 / 625 R

220-240V AC 50/60Hz UGR<19 Design: INHOUSE

IP20

LED Einbauleuchte aus Stahlblech · Oberfläche pulverbeschichtet · Lichteinsatz wechselbar · inkl. Converter
LED recessed luminaire made of sheet steel · powder-coated surface · light insert can be changed · incl. converter
Lampada LED ad incasso in lamiera d'acciaio · verniciata a polveri · Inserti luce intercambiabili · converter incluso
Luminaire encastrée LED · Surface revêtue de poudre · Inserts lumineux interchangeables · Convertisseur inclus

INTERO M600 R

CODE	SYS W	L mm	LUMEN
225-02120232WW05Y	32 - 50	1197	4210 - 7240
225-02120332WW05Y	32 - 60	1490	4470 - 8920

Strom einstellbar (300 - 600mA)
Power switchable (300 - 600mA)
Austrahlwinkel: 2 x 80° / Beam angle: 2 x 80°

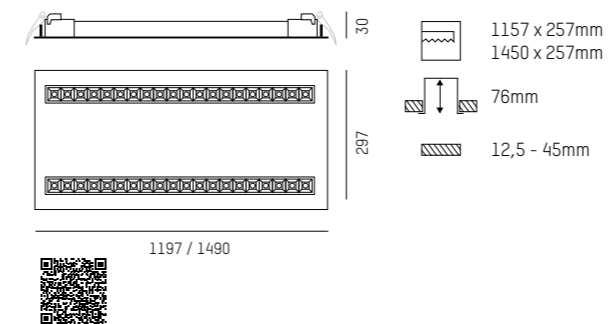

INTERO M625 R

CODE	SYS W	L mm	LUMEN
225-02120532WW05Y	32 - 50	1248	4210 - 7240
225-02120632WW05Y	32 - 60	1548	4470 - 8920

Strom einstellbar (300 - 600mA)
Power switchable (300 - 600mA)
Austrahlwinkel: 2 x 80° / Beam angle: 2 x 80°

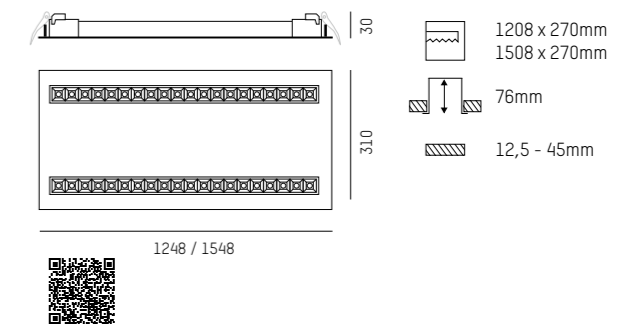

BEFESTIGUNGSKLAMMERN	SET
MOUNTING CLAMBS	SET
225-0030090000000	4 pcs.



COMPLETE CODE

WW = LIGHT COLOUR	Y = DIMMABLE
LED 3000K = 19 CRI<80	switchable = 0
LED 4000K = 14 CRI<80	DALI dim = d

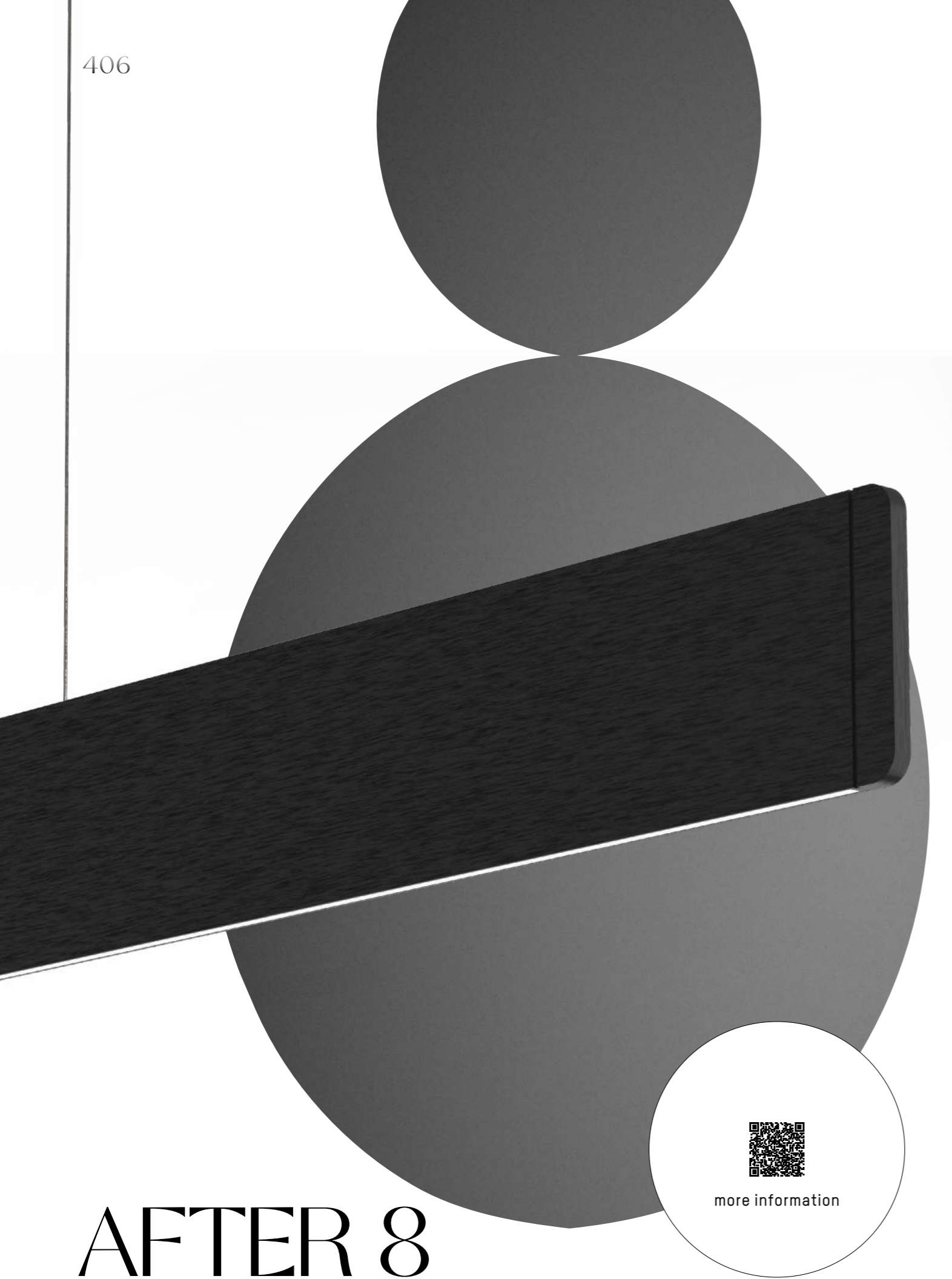

AFTER 8



more information

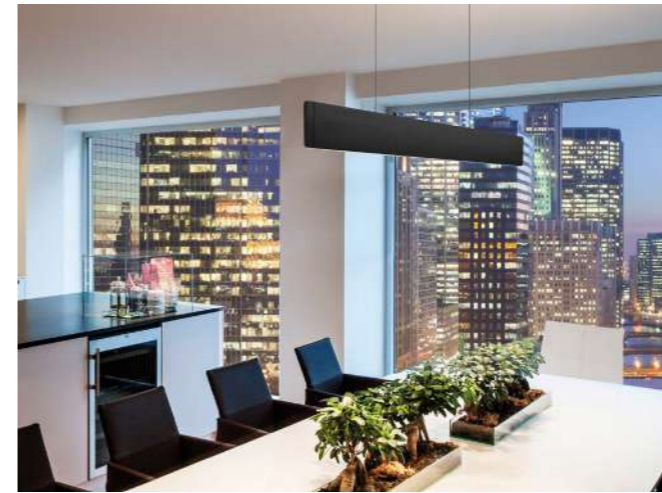

Private residence, Photo: Joachim Rauch



Private residence, Photo: Joachim Rauch



Private residence, Photo: Joachim Rauch



Raiffeisenbank Attersee-Süd, Nußdorf, Austria, Design + Architektur AREA.at
Photo: Joachim Rauch



Der Mayrhofer, Pasching, Austria, Photo: Joachim Rauch

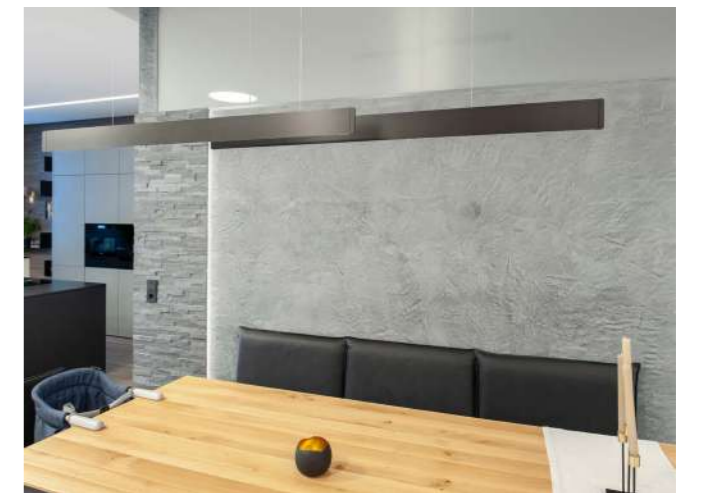

Private residence, Photo: Joachim Rauch



AFTER 8

PERFECT FOR EVERY LIGHTING SOLUTION

Die grazile Pendelleuchte AFTER 8 hat schon immer mit ihrer klaren Formensprache und einem extra schlanken Design beeindruckt. Sie besticht durch schwebende Leichtigkeit und integriert sich exzellent in jedem Ambiente. Der schlanke Leuchtenkörper aus hochwertigem, gebürstetem Aluminium ist in den eloxierten Farben Schwarz, Schiefer und Champagner erhältlich. AFTER 8 erhellt mit direkt/indirektem Licht harmonisch den Raum und setzt auf minimalistische Weise edle Akzente.

The graceful AFTER 8 pendant luminaire has always impressed with its clear design language and extra slim design. It captivates with its floating lightness and integrates excellently into any ambience. The slim luminaire body made of high-quality brushed aluminium is available in the anodised colours black, slate and champagne. AFTER 8 illuminates the room harmoniously with direct/indirect light and sets elegant accents in a minimalist way.

Design: INHOUSE

VARIATIONS

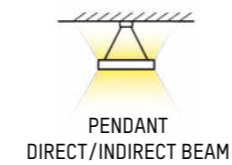

FORM



LED COLOURS

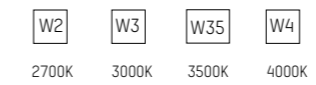

COLOURS

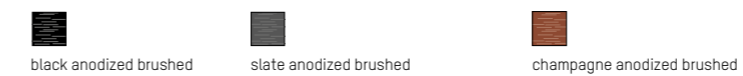

extra slim - 6mm width



Light & Building 2024
Frankfurt, Germany
Photo: Joachim Rauch

HIGHLIGHTS

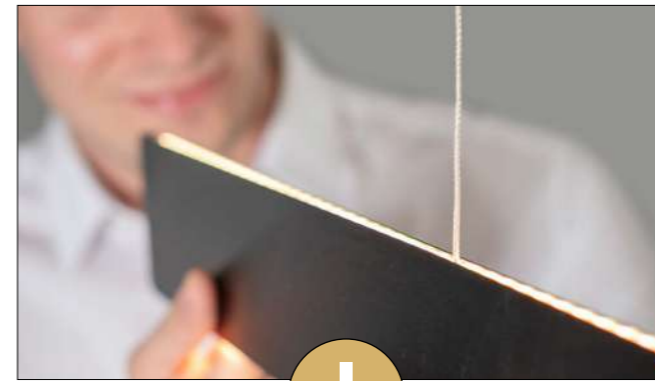

Minimalistische Leuchtenbreite von nur 6mm.
Minimalist luminaire width of only 6mm.



Hochwertige eloxierte Oberfläche aus gebürstetem Aluminium.
High-quality anodised surface made of brushed aluminium.

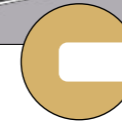
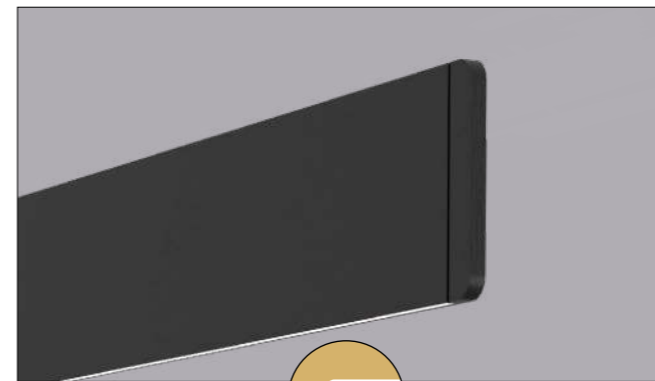

Design-Element - abgerundete Endkappen mit Schattenfuge aus gebürstetem und eloxiertem Aluminium.
Design element - rounded end caps with shadow gap in brushed and anodised aluminium.

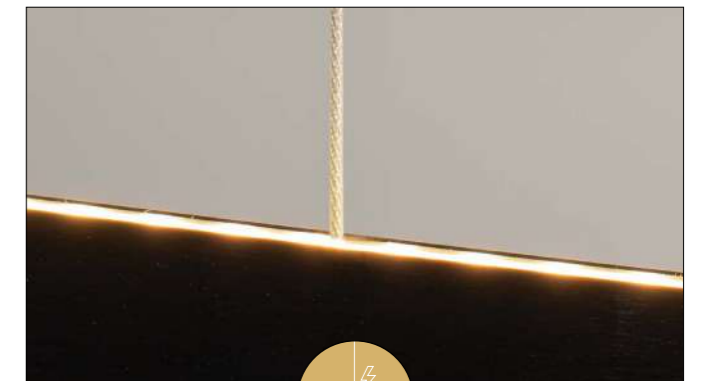

Die Spannungsführung erfolgt elegant und unauffällig über die Stahlseile, die gleichzeitig zur Abhängung dienen.
The tensioning is carried out elegantly and inconspicuously via the steel cables, which also serve as suspension.



AFTER 8 SHORT

AFTER 8 SHORT PDI

220-240V AC

50/60Hz

Design: INHOUSE

IP20

LED Hängeleuchte · extra schlank · aus Aluminium mit Miniatur-LEDs · Oberfläche eloxiert · satinierte Abdeckung für homogenes Lichtbild
 LED suspension · extra slim · in aluminium with miniature LEDs · anodised surface · satined diffuser for homogeneous light
 Sospensione LED · extra sottile · in alluminio con LED miniaturizzati · superficie anodizzata · diffusore satinato per illuminazione omogenea
 Suspension LED · extra fin · en aluminium avec LED miniatures · surface anodisée · diffuseur satiné pour une lumière homogène

CODE	SYS W	L mm	LUMEN
678-003CC10WWXXY	41	1232	1510 - 1790



COMPLETE CODE																																			
WW = LIGHT COLOUR	CC = COLOUR CEILING BASE	XX = COLOUR LUMINAIRE	Y = DIMMABLE																																
<table border="0"> <tr> <td>W2</td> <td>LED 2700K = 23 CRI>90</td> <td>W</td> <td>white = 01</td> <td>BA</td> <td>black anodized brushed = 2q</td> <td>Ⓛ</td> <td>DALI dim = d</td> </tr> <tr> <td>W3</td> <td>LED 3000K = 29 CRI>90</td> <td>S</td> <td>black = 02</td> <td>CA</td> <td>champagne anodized brushed = 2s</td> <td>Ⓟ</td> <td>BLUETOOTH dim = b</td> </tr> <tr> <td>W35</td> <td>LED 3500K = 27 CRI>90</td> <td></td> <td></td> <td>SA</td> <td>slate anodized brushed = 2r</td> <td></td> <td></td> </tr> <tr> <td>W4</td> <td>LED 4000K = 24 CRI>90</td> <td></td> <td></td> <td></td> <td></td> <td></td> <td></td> </tr> </table>	W2	LED 2700K = 23 CRI>90	W	white = 01	BA	black anodized brushed = 2q	Ⓛ	DALI dim = d	W3	LED 3000K = 29 CRI>90	S	black = 02	CA	champagne anodized brushed = 2s	Ⓟ	BLUETOOTH dim = b	W35	LED 3500K = 27 CRI>90			SA	slate anodized brushed = 2r			W4	LED 4000K = 24 CRI>90									
W2	LED 2700K = 23 CRI>90	W	white = 01	BA	black anodized brushed = 2q	Ⓛ	DALI dim = d																												
W3	LED 3000K = 29 CRI>90	S	black = 02	CA	champagne anodized brushed = 2s	Ⓟ	BLUETOOTH dim = b																												
W35	LED 3500K = 27 CRI>90			SA	slate anodized brushed = 2r																														
W4	LED 4000K = 24 CRI>90																																		



AFTER 8 LONG

AFTER 8 LONG PDI

220-240V AC

50/60Hz

Design: INHOUSE

IP20

LED Hängeleuchte · extra schlank · aus Aluminium mit Miniatur-LEDs · Oberfläche eloxiert · satinierte Abdeckung für homogenes Lichtbild
 LED suspension · extra slim · in aluminium with miniature LEDs · anodised surface · satined diffuser for homogeneous light
 Sospensione LED · extra sottile · in alluminio con LED miniaturizzati · superficie anodizzata · diffusore satinato per illuminazione omogenea
 Suspension LED · extra fin · en aluminium avec LED miniatures · surface anodisée · diffuseur satiné pour une lumière homogène

CODE	SYS W	L mm	LUMEN
678-004CC10WWXXY	51	1532	1880 - 2240

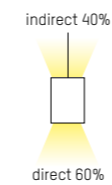
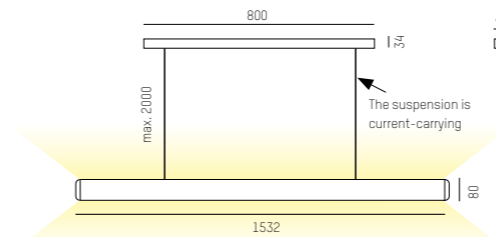

COMPLETE CODE

WW = LIGHT COLOUR	CC = COLOUR CEILING BASE	XX = COLOUR LUMINAIRE	Y = DIMMABLE
W2 LED 2700K = 23 CRI>90	W white = 01	BA black anodized brushed = 2q	Ⓛ DALI dim = d
W3 LED 3000K = 29 CRI>90	S black = 02	CA champagne anodized brushed = 2s	Ⓟ BLUETOOTH dim = b
W35 LED 3500K = 27 CRI>90		SA slate anodized brushed = 2r	
W4 LED 4000K = 24 CRI>90			

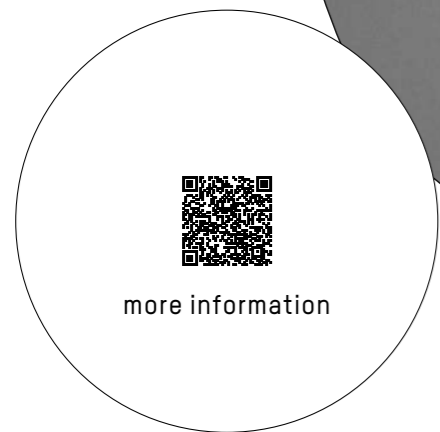

PILLE



Wimberger Haus, Lasberg, Austria, Planning & Realisation: Ben Elmecker
Photo: Joachim Rauch

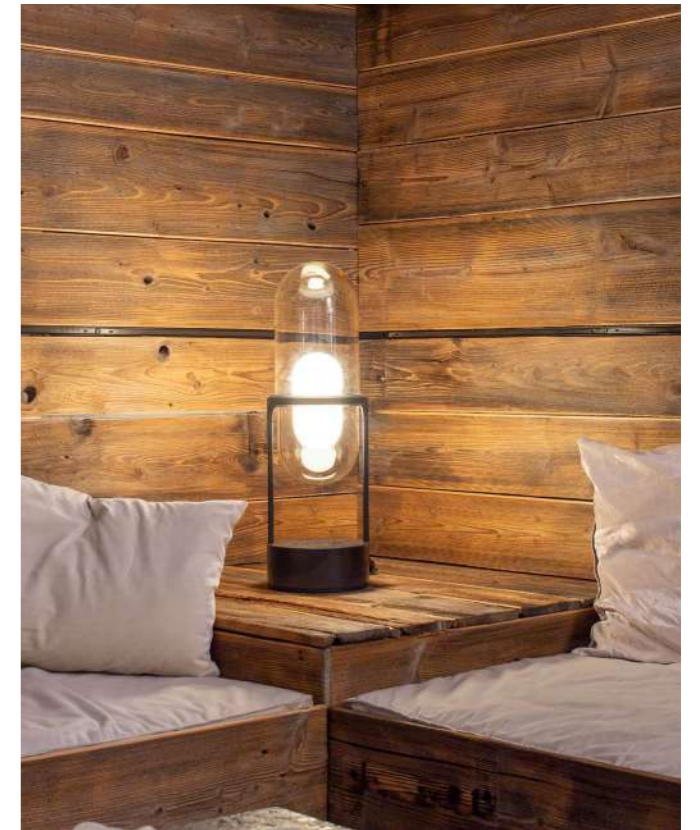

Private residence, Austria, Photo: Joachim Rauch



Optik Tieber, Schladming, Austria, Photo: Joachim Rauch

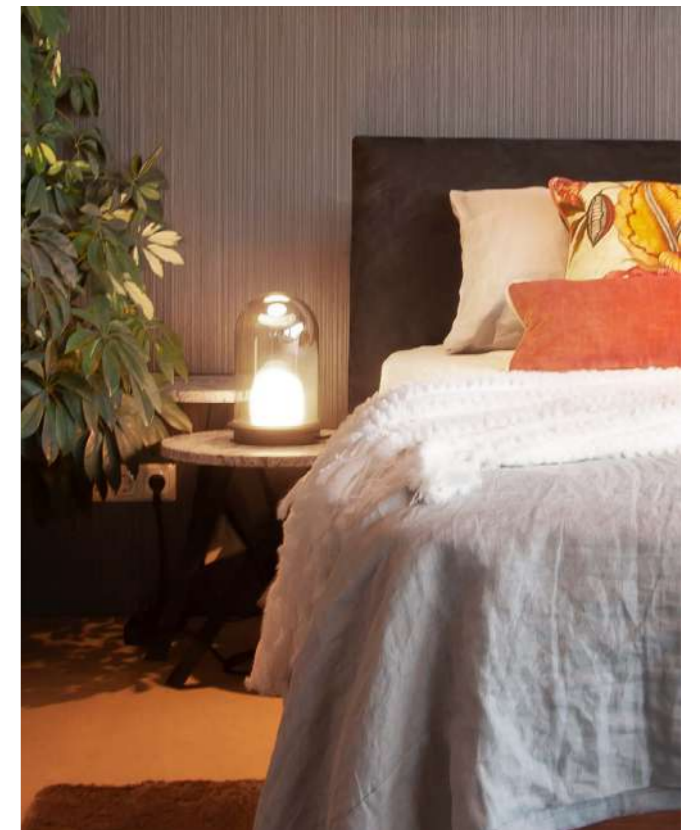

Private residence, Austria, Photo: Joachim Rauch



Solar One, Stegersbach, Austria
Photo: Joachim Rauch

PILLE

MAKES THE PULSE RISE

Die vom Designer Klaus Nolting entworfene Leuchtenfamilie besteht aus mundgeblasenem Kristallglas aus europäischer Fertigung. Der Glaskörper setzt sich aus zwei farblich, harmonisch aufeinander abgestimmten Teilen zusammen. Verbindendes Element ist ein horizontal platzierter Ring, aus dem die Glaskörper entspringen und der gleichzeitig die LEDs trägt. Die Tisch- und Stehleuchte besitzen einen Standfuß aus Stein sowie ein hochwertiges Push2Dim-Kabel. Die PILLE Single besticht mit charmantem Retro-Look und ist als Wand-, Decken- und Tischleuchte erhältlich.

The luminaire family designed by Klaus Nolting consists of mouth-blown crystal glass from European production. The glass body is composed of two parts in harmonious colours. The connecting element is a horizontally placed ring from which the glass bodies arise and which at the same time carries the LEDs. The table and floor lamps have a base out of stone and a high-quality Push2Dim cable. The PILLE Single impresses with a charming retro look and is available as a wall, ceiling and table lamp.

Design: Klaus Nolting

VARIATIONS

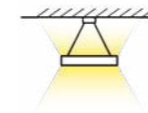

PENDANT

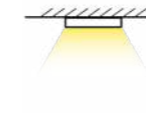

SURFACE



FLOOR



TABLE

LED COLOURS

W2

2700K

GLASS COLOURS



grey



champagner



rose

SPECIALS



reddot winner 2022



BIG SEE
Product Design
Award 2023
Winner



PILLE PDI

PILLE PDI

220-240V AC

50/60Hz

2700K / PREMIUM CRI>90

Design: Klaus Nolting

IP20

LED Hängeleuchte aus mundgeblasenem Kristallglas · unterschiedliche Farbkombinationen erhältlich · DALI dimmbar
 LED suspension made of mouth-blown crystal glass · different colour combinations available · DALI dimmable
 Sospensione LED in cristallo soffiato a bocca · diverse combinazioni di colori disponibili · dimmerabile DALI
 Suspension LED en verre de cristal soufflé bouche · différentes combinaisons de couleurs disponibles · dimmable DALI

CODE	SYS W	LUMEN
737-10013XXdv1	27	1290 - 1650

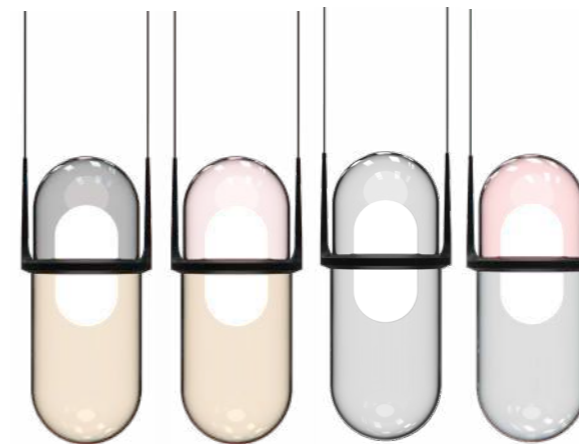
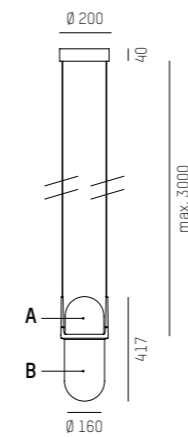

COMPLETE CODE

XX = COLOUR GLASS **A** / GLASS **B**

grey / champagne = **gh** rose / champagne = **ph** grey / grey = **gg** rose / grey = **pg**



PILLE F / PILLE T

PILLE F / PILLE T

220-240V AC 50/60Hz 2700K / PREMIUM CRI>90 Design: Klaus Nolting

IP20

Steh- oder Tischleuchte aus mundgeblasenem Kristallglas · diverse Farbkombinationen erhältlich · Fuß aus Naturstein
 Floor- or table lamp made of mouth-blown crystal glass · different colour combinations available · natural stone base
 Piantana LED in cristallo soffiato a bocca · diverse combinazioni di colori disponibili · base in pietra naturale
 Lampadaire ou lampe de table en verre de cristal soufflé bouche · différentes combinaisons de couleurs disponibles · pied en pierre naturelle

PILLE F

CODE	SYS W	LUMEN
737-60013XXdv1	27	1290 - 1650

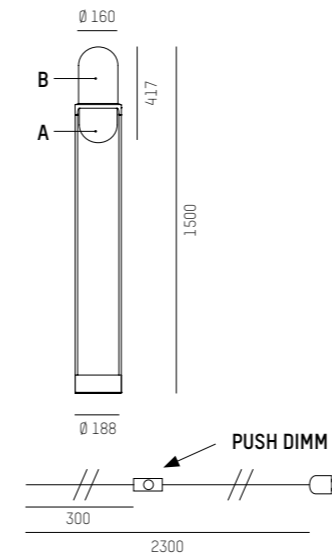

PILLE T

CODE	SYS W	LUMEN
737-50033XXdv1	27	1290 - 1650

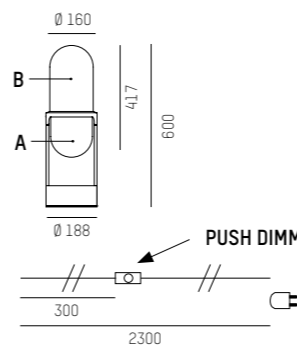

PILLE F



PILLE T

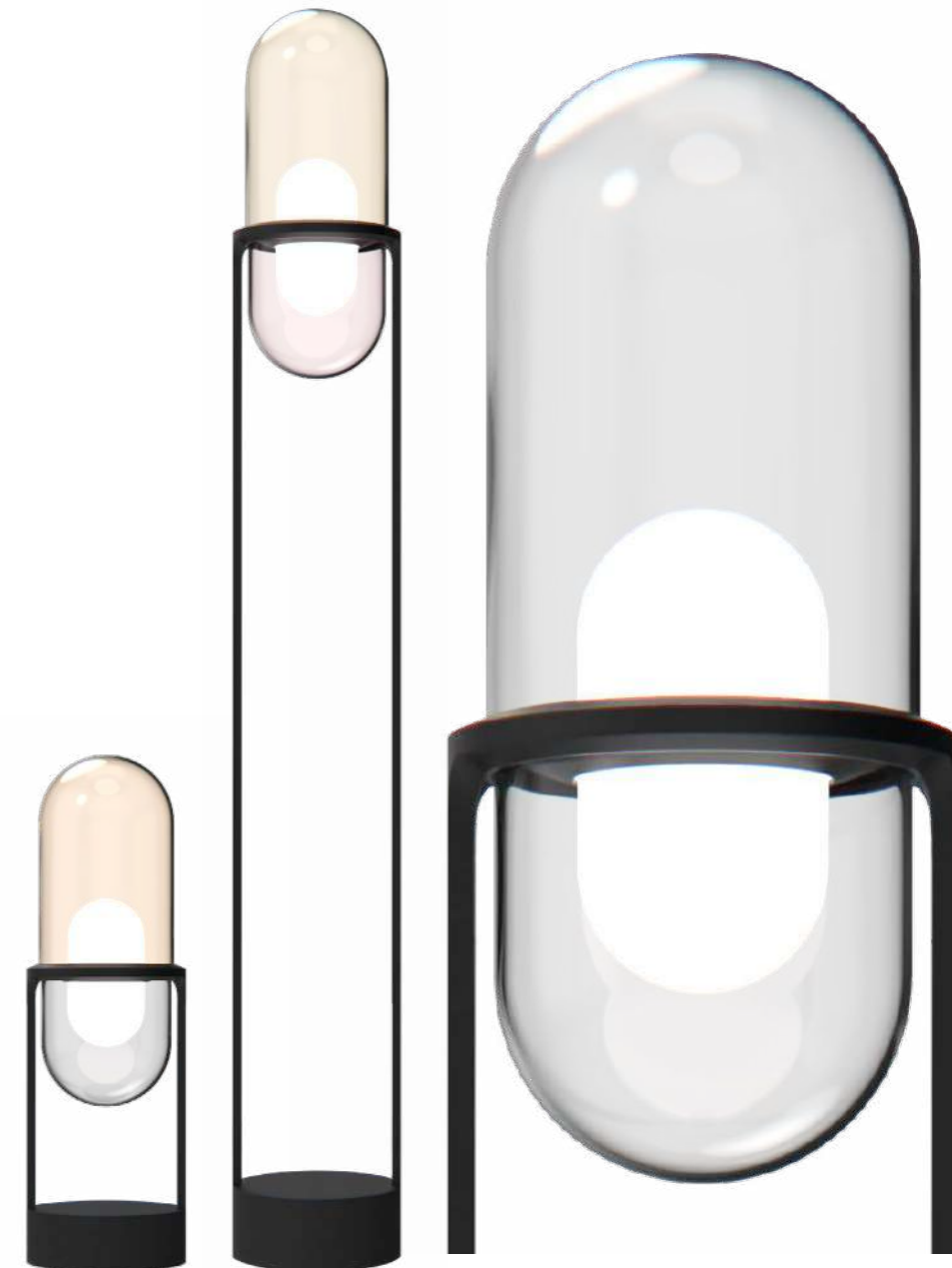

COMPLETE CODE

XX = COLOUR GLASS A / GLASS B

grey / champagne = gh	rose / champagne = ph	grey / grey = gg	rose / grey = pg
-----------------------	-----------------------	------------------	------------------



Private residence, Austria, Photo: Joachim Rauch

PILLE SINGLE T

PILLE SINGLE T

220-240V AC

50/60Hz

2700K / PREMIUM CRI>90

Design: Klaus Nolting

IP20

LED Tischleuchte aus mundgeblasenem Kristallglas · unterschiedliche Farbkombinationen erhältlich · Fuß aus Naturstein · Push Dimmer am Kabel
 LED table luminaire made of mouth-blown crystal glass · different colour combinations available · natural stone base · push dimmer on cable
 Lampada LED da tavolo in cristallo soffiato a bocca · diverse combinazioni di colori disponibili · base in pietra naturale · tasto push dimm sul cavo
 Lampe de table en verre de cristal soufflé bouche · différentes combinaisons de couleurs disponibles · pied en pierre naturelle · push dimmer sur le câble

CODE	SYS W	LUMEN
737-500236XVv1	14	630-960

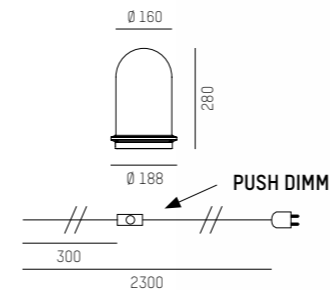

COMPLETE CODE

X = COLOUR GLASS

Y = DIMMABLE

grey = g

champagne = h

switchable = 0

push dimm = t



Der Schrenk, Passail, Austria, Photo: Joachim Rauch

PILLE SINGLE SD

PILLE SINGLE L SD / PILLE SINGLE M SD

220-240V AC

50/60Hz

2700K / PREMIUM CRI>90

Design: Klaus Nolting

IP20

LED Deckenleuchte aus mundgeblasenem Kristallglas - in 2 oder 3 Glasfarben erhältlich - DALI dimmbar
 LED ceiling luminaire made of mouth-blown crystal glass - available in 2 or 3 glass colours - DALI dimmable
 Lampada LED a plafone in cristallo soffiato a bocca - vetri disponibili in 2 o 3 colori - dimmerabile DALI
 Plafonnier LED en verre de cristal soufflé bouche - disponible en 2 ou 3 couleurs de verre - dimmable DALI

PILLE SINGLE L SD

CODE	SYS W	LUMEN
737-200136Xdv1	14	630-960

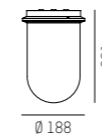

PILLE SINGLE M SD

CODE	SYS W	LUMEN
737-200036Xdv1	14	710-940

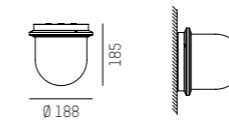

PILLE SINGLE L



PILLE SINGLE M



COMPLETE CODE

X = COLOUR GLASS

grey = g

champagne = h

rose = p (ONLY FOR PILLE SINGLE M SD)



COCKTAIL PD

COCKTAIL PD

220-240V AC

50/60Hz

Design: Klaus Nolting

IP20

Dekorative Hängeleuchte · Oberfläche schwarz pulverbeschichtet · kombinierbar mit 3 verschiedenen mundgeblasenen Gläsern
 Decorative pendant lamp · surface black powder-coated · can be combined with 3 different mouth-blown glasses
 Lampada decorativa a sospensione · verniciato a polveri in nero · combinabile con 3 diversi vetri soffiati
 Lampe décorative suspendue · vernissé à poudres en noir · combinable avec 3 verres soufflés

COCKTAIL S PD

CODE	SYS W	LUMEN
110-011111X00W60Y	10	250 - 300

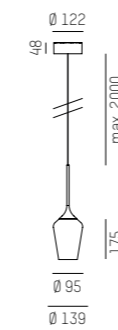

COCKTAIL M PD

CODE	SYS W	LUMEN
110-011121X00W60Y	10	250 - 300

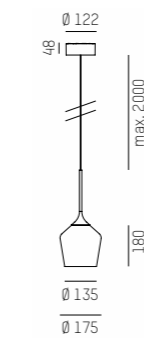

COCKTAIL L PD

CODE	SYS W	LUMEN
110-011131X00W60Y	10	330 - 370

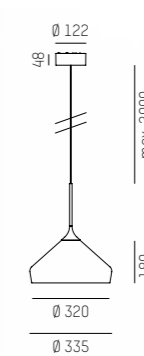

KABELHALTER / CABLE HOLDER

CODE

305-0001



COCKTAIL S



COCKTAIL M



COCKTAIL L



COMPLETE CODE

W = LIGHT COLOUR	X = COLOUR GLASS	Y = DIMMABLE														
<table border="1"> <tr> <td>W2</td> <td>LED 2700K = 3 CRI>90</td> </tr> <tr> <td>W3</td> <td>LED 3000K = 9 CRI>90</td> </tr> </table>	W2	LED 2700K = 3 CRI>90	W3	LED 3000K = 9 CRI>90	<table border="1"> <tr> <td>SB</td> <td>smoked grey = 1</td> </tr> <tr> <td>B</td> <td>brown = 2</td> </tr> <tr> <td>V</td> <td>violett = 3</td> </tr> </table>	SB	smoked grey = 1	B	brown = 2	V	violett = 3	<table border="1"> <tr> <td>S</td> <td>switchable = 0</td> </tr> <tr> <td>D</td> <td>DALI dim = d</td> </tr> </table>	S	switchable = 0	D	DALI dim = d
W2	LED 2700K = 3 CRI>90															
W3	LED 3000K = 9 CRI>90															
SB	smoked grey = 1															
B	brown = 2															
V	violett = 3															
S	switchable = 0															
D	DALI dim = d															



Raiffeisen Arena, Linz, Austria, Photo: Joachim Rauch

CORPA PD

CORPA VOLARE

220-240V AC 50/60Hz Design: Rainer Mutsch QPAR 16 / GU10 / Retrofit max. 9W

IP20

Dekorative Hängeleuchte · Oberfläche schwarz pulverbeschichtet · kombinierbar mit 3 verschiedenen mundgeblasenen Gläsern
 Decorative pendant lamp · surface black powder-coated · can be combined with 3 different mouth-blown glasses
 Lampada decorativa a sospensione · verniciato a polveri in nero · combinabile con 3 diversi vetri soffiati
 Lampe décorative suspendue · vernissé à poudres en noir · combinable avec 3 verres soufflés

CORPA IRIS S PD

CODE
257-02111X6000600

CORPA IRIS L PD

CODE
257-02112X6000600

CORPA BASS PD

CODE
257-02113X6000600

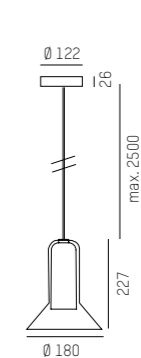
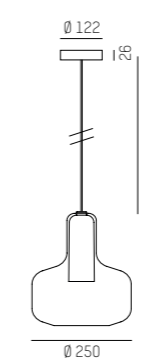
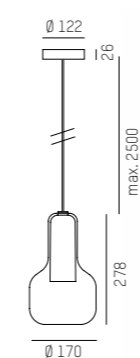

KABELHALTER / CABLE HOLDER

CODE
305-0001



CORPA IRIS S



CORPA IRIS L



CORPA BASS



LEUCHTMITTEL 6W CRI>90

BULB 6W CRI>90

30-752517

30-707692

LICHTFARBE

COLOUR

2700K / 355lm

3000K / 375lm



COMPLETE CODE FOR ADAPTER

X = COLOUR GLASS

champagne = 1

grey = 2

rose = 3 (ONLY FOR CORPA IRIS S & L PD)

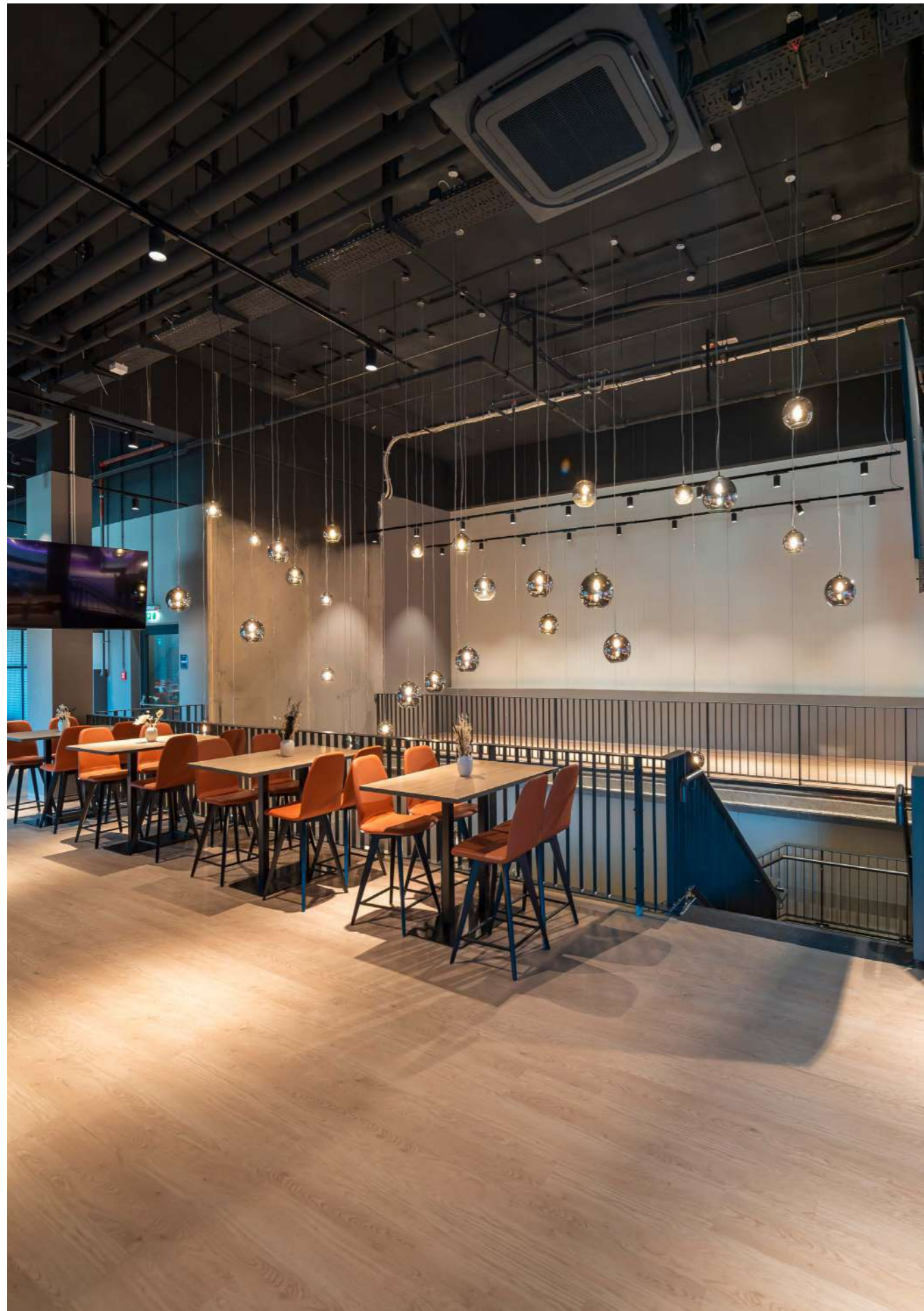

Raiffeisenarena, Linz, Austria, Photo: Joachim Rauch

LOON MINI BALL

LOON MINI PD / LOON MINI BALL PD

IP20

220-240V AC 50/60Hz Design: INHOUSE D45 / E14 / Retrofit max. 4W

Dekorative Hängeleuchte im Retro-Design · hochwertige Glaskugel mundgeblasen in 3 Farben · speziell konstruierte Fassung für bündige Montage
 Decorative suspended luminaire in retro design · high-quality blown glass ball in 3 different colours · special socket construction for flush mounting
 Sospensione con design decorativo · sfera di vetro soffiato in 3 colori differenti · portalamпада speciale per montaggio a filo
 Suspension decorative · boule en verre soufflé 3 couleurs au choix · douille de lampe spéciale.

LOON MINI PD

CODE
636-0110006000600

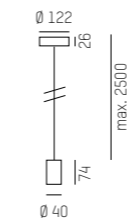

KABELHALTER / CABLE HOLDER

CODE
305-0001



LOON MINI



LOON MINI BALL PD

CODE
636-01311X6000600

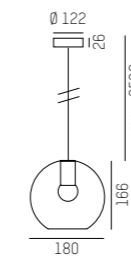

LOON MINI BALL



COMPLETE CODE

X = COLOUR GLASS

grey = 1

amber = 2

brown = 3



Private residence, Austria, Photo: F1 Fotodesign, Oliver Mitterhumer

LOON BALL

LOON PD / LOON BALL PD

IP20

220-240V AC 50/60Hz Design: INHOUSE A60 / E27 / Retrofit max. 7W

Dekorative Hängeleuchte im Retro-Design · hochwertige Glaskugel mundgeblasen in 3 Farben · speziell konstruierte Fassung für bündige Montage
 Decorative suspended luminaire in retro design · high-quality blown glass ball in 3 different colours · special socket construction for flush mounting
 Sospensione con design decorativo · sfera di vetro soffiato in 3 colori differenti · portalamпада speciale per montaggio a filo
 Suspension decorative · boule en verre soufflé 3 couleurs au choix · douille de lampe spéciale.

LOON PD

CODE	COLOUR
636-0210005000500	W
636-0210006000600	S

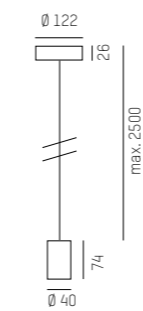

LOON BALL PD

CODE	COLOUR
636-02312X6000600	S

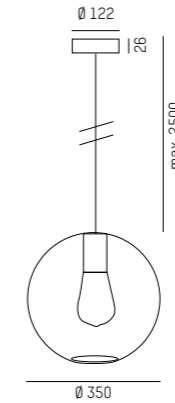

KABELHALTER / CABLE HOLDER

CODE

305-0001



LOON



LOON BALL



COMPLETE CODE

X = COLOUR GLASS

grey = 1

AM amber = 2

B brown = 3



WIZARD

MAGICAL MOMENTS OF LIGHT

WIZARD ist eine charmante Hängeleuchte aus pulverbeschichtetem Aluminium. Der Metallschirm ist in 2 unterschiedlichen Größen sowie verschiedenen Farbkombinationen erhältlich und kann je nach Wunsch flexibel in der Schräge eingestellt werden. Der direkte und indirekte Lichtaustritt sorgen für eine zauberhafte Lichtstimmung im Raum.

WIZARD is a charming pendant luminaire made of powder-coated aluminium. The metal cover is available in two different sizes as well as various colour combinations and the angle can be adjusted according to your wishes. The direct and indirect light output provides the room with magical mood lighting.

Design: Serge Cornelissen

VARIATIONS

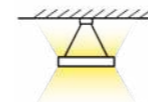

PENDANT
DIRECT/INDIRECT BEAM

COLOURS



white



black



gold



copper



COLOUR OPTIONS

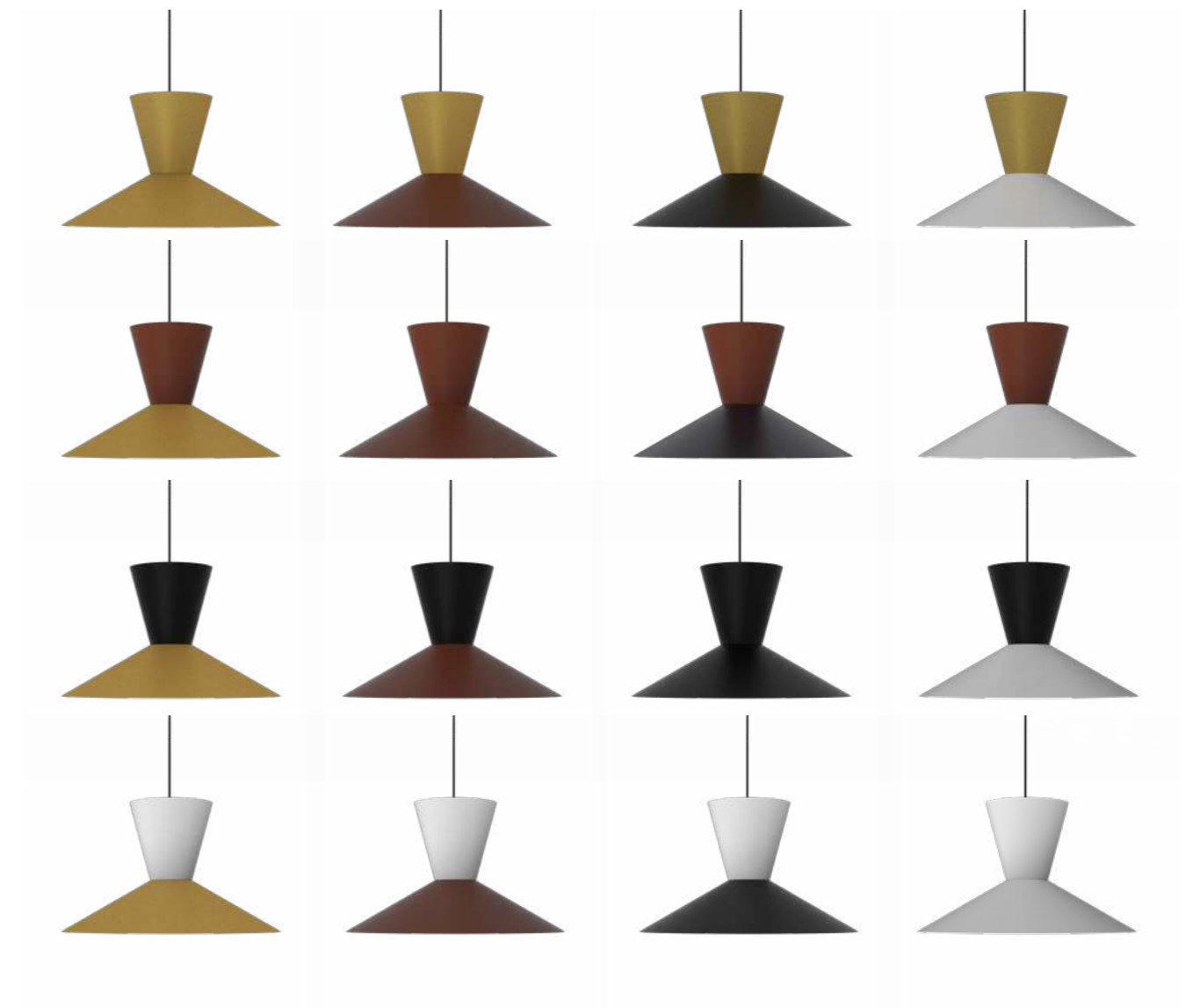



WIZARD PDI

WIZARD PDI

220-240V AC 50/60Hz A60 ECO / E27 / max. 45W Design: Serge Cornelissen

IP20

Hängeleuchte mit E27-Fassung · schwenkbarer Schirm aus Aluminium pulverbeschichtet · Lichtstimmung durch direkten und indirekten Lichtaustritt
 Suspension with E27 socket · flexible adjustable shade made of powder-coated aluminium · lighting mood through direct and indirect light emission
 Sospensione con portalampana E27 · paralume flessibile e regolabile in alluminio verniciata a polvere · emissione luminosa diretta ed indiretta
 Suspension avec douille E27 · abat-jour en aluminium thermolaquée réglable de manière flexible · directe et indirecte de la lumière

WIZARD M PDI

CODE

114-01110006XY500

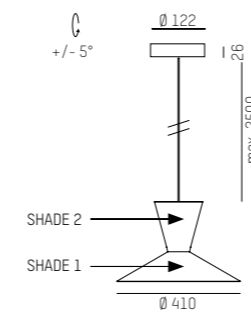

WIZARD L PDI

CODE

114-02110006XY500

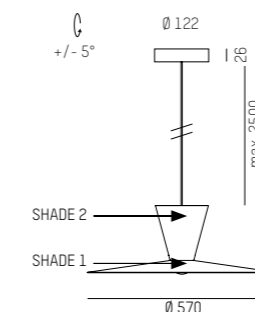

KABELHALTER / CABLE HOLDER

CODE

305-0001



WIZARD M



WIZARD L



COMPLETE CODE

X = COLOUR SHADE 1

- W white = 5
- S black = 6
- G gold = 7
- K copper = 8

Y = COLOUR SHADE 2

- W white = 5
- S black = 6
- G gold = 7
- K copper = 8



SVEN

SWAP AS YOU WANT

SVEN ist eine wandelbare Leuchte in schlichtem Retrodesign. Der Leuchtschirm ist in verschiedenen Farben und Materialien erhältlich. Durch einfaches Tauschen des Schirmes lässt sich die Leuchte an unterschiedliche Anlässe oder Trends individuell anpassen. Ein flexibler Silikon Diffusor schafft eine angenehme und weiche Lichtverteilung. Erhältlich ist SVEN als Hängeleuchte sowie als stilvoller Eyecatcher an der Decke bzw. Wand.

SVEN is a convertible luminaire in a simple retro design. The luminaire cover is available in various colours and materials. By simply exchanging the cover the luminaire can be adjusted for different occasions or to individual trends. The flexible silicone diffuser creates a pleasant and soft distribution of light. SVEN is available as a pendant luminaire as well as a stylish eye-catcher on the wall or ceiling.

Design: Rainer Mutsch

VARIATIONS

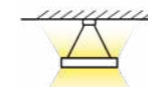

PENDANT

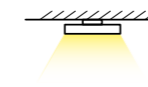

WALL/CEILING

LED COLOURS

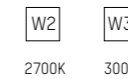

2700K 3000K

COLOURS

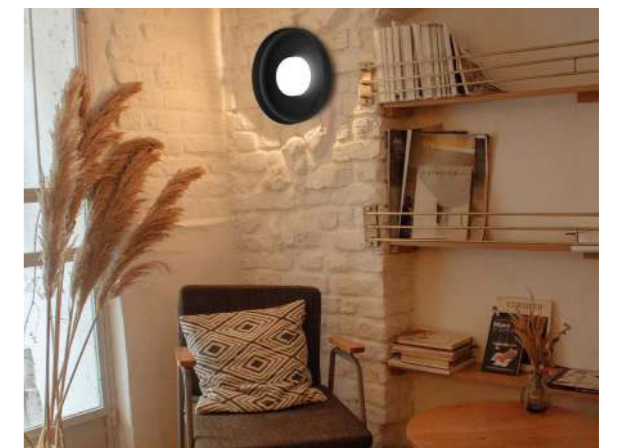



Saliencie Consulting, Skopje, Macedonia, Photo: Property One Design and Development

SVEN

SVEN PD / SD

220-240V AC 50/60Hz Design: Rainer Mutsch

IP20

Leuchte mit Schirm aus Metall oder Filz · Oberfläche pulverbeschichtet · weiche Lichtverteilung durch Silikondiffuser · schaltbar oder DALI dimmbar (PD)
 Luminaire with metal or felt shade · surface powder-coated · soft light distribution due to silicone diffuser · switchable or DALI dimmable (PD)
 Lampade con paralume in metallo o feltro · superficie verniciata a polvere · diffusore in silicone · on/off o dimmerabile DALI (PD)
 Luminaires avec abat-jour en métal ou feutre · surface thermolaquée · diffuseur flexible en silicone · on/off ou dimmable DALI (PD)

SVEN PD

CODE	SYS W	MATERIAL	COLOUR	LUMEN
136-1003s6gY	15	metall	merlot	1045
136-1003s6hY	15	metall	creme	1230
136-1003s6lY	15	metall	forest	1030
136-1003s66Y	15	metall	black	1040
136-1004s69Y	15	felt	anthrazit	1045

Lichtfarbe 2700 oder 3000K manuell einstellbar
 Light colour 2700 or 3000K adjustable

SVEN SD

CODE	SYS W	MATERIAL	COLOUR	LUMEN
136-2003s6gd	15	metall	merlot	850
136-2003s6hd	15	metall	creme	1000
136-2003s6ld	15	metall	forest	850
136-2003s66d	15	metall	black	850
136-2004s69d	15	felt	anthrazit	1045

Lichtfarbe 2700 oder 3000K manuell einstellbar / DALI dim
 Light colour 2700 or 3000K adjustable / DALI dim

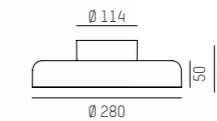
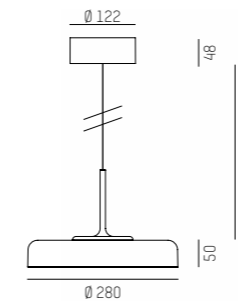

KABELHALTER / CABLE HOLDER

CODE

305-0001



SVEN PD



SVEN SD



COMPLETE CODE

Y = DIMMABLE

switchable = 0

DALI dim = d



Gmundner Keramik,
Gmunden, Austria,
Photo: Joachim Rauch



more information

FRANZ

TIMELESS, TRADITIONAL & HANDCRAFTED

Gmundner Keramik und Molto Luce, zwei oberösterreichische Betriebe mit jeweils eigener Produktion, gelten als Experten ihres Gebietes. Im Rahmen eines Designprojektes entwickelten sie gemeinsam die charmante Leuchtenserie FRANZ, welche eine Pendel-, Decken- und Wandleuchte umfasst. Die hochwertigen Keramikschirme werden mit Liebe zum Detail in Handarbeit in der Gmundner Keramik Manufaktur gefertigt und bemalt. So wird jede Leuchte zum Unikat. Ob mit traditionellem "Hirsch" oder in drei wunderschönen Farben glasiert und gebrannt, ist FRANZ perfekt für einen Einsatz im privaten Wohnraum oder in der Gastronomie geschaffen. Technisch ist die Leuchte mit einer modernen Light Engine von Molto Luce ausgestattet, welche eine sanfte und besonders angenehme Verteilung des Lichts ermöglicht.

Gmundner Keramik and Molto Luce, two Upper Austrian companies with their own production each, are renowned experts in their areas. As part of a design project, they developed the charming series of luminaires FRANZ together including a pendant luminaire, a ceiling and a wall mounted luminaire. The high-quality ceramic shades are made and painted by hand with love for detail in the manufactory of Gmundner Keramik. Therefore, every luminaire is unique. Whether painted with the traditional deer or glazed and fired in three beautiful colours, FRANZ is perfect for the private living space or in restaurants. The luminaire is equipped with the modern Light Engine by Molto Luce for a soft and especially pleasant light distribution.

Design: Gmundner Keramik & Rainer Mutsc

VARIATIONS

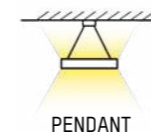

PENDANT

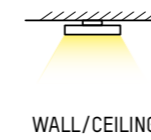

WALL/CEILING

LED COLOURS

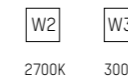

2700K 3000K

COLOURS



omeagreen bronze seablue deer grey



seablue

bronze

deer grey 1 x big

omeagreen



FRANZ

FRANZ PD / SD

IP20

220-240V AC 50/60Hz Design: Gmundner Keramik & Rainer Mutsch

Leuchte mit Schirm aus Keramik · Oberfläche gebrannt und glasiert · weiche Lichtverteilung durch Silikondiffusor · schaltbar oder DALI dimmbar (PD)
 Luminaire with ceramic shade · surface fired and glazed · soft light distribution due to silicone diffuser · switchable or DALI dimmable (PD)
 Lampade con paralume in ceramica · superficie cotta e smaltato · diffusore in silicone · on off o dimmerabile DALI (PD)
 Luminaires avec abat-jour en céramique · surface cuit et émaillé · diffuseur flexible en silicone · on/off ou dimmable DALI (PD)

FRANZ PD

CODE	SYS W	MATERIAL	COLOUR	LUMEN
136-1005s6fY	15	ceramics	omeagreen	1045
136-1005s6bY	15	ceramics	seablue	1045
136-1005s6rY	15	ceramics	bronze	1045
136-1005s6sY	15	ceramics	deer grey 3 x small	1045

Lichtfarbe 2700 oder 3000K manuell einstellbar
 Light colour 2700 or 3000K adjustable

FRANZ SD

CODE	SYS W	MATERIAL	COLOUR	LUMEN
136-2005s6fd	15	ceramics	omeagreen	850
136-2005s6bd	15	ceramics	seablue	850
136-2005s6rd	15	ceramics	bronze	850
136-2005s6sd	15	ceramics	deer grey 1 x big	850
136-2006s6sd	15	ceramics	deer grey 3 x small	850

Lichtfarbe 2700 oder 3000K manuell einstellbar / DALI dim
 Light colour 2700 or 3000K adjustable / DALI dim

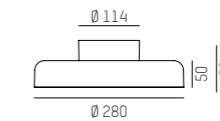

KABELHALTER / CABLE HOLDER

CODE
 305-0001



FRANZ PD



FRANZ SD



COMPLETE CODE

Y = DIMMABLE

Ⓢ switchable = 0

Ⓣ DALI dim = d



Salzkammergutlodge, Ebensee, Austria, Photo: Joachim Rauch

LORA

LORA PD

220-240V AC 50/60Hz CRI>90

IP20

Hängeleuchte aus Aluminium · in unterschiedlichen trendigen Schirmausführungen aus Stahl · Oberfläche pulverbeschichtet · schaltbar oder DALI dim.
 Suspension in aluminium · steel shade in different trendy designs · surface powder-coated · switchable or DALI dimmable
 Sospensione alluminio · paralume in diverse forme particolari · superficie verniciata a polvere · on/off o dimmerabile DALI
 Suspension en aluminium · abat-jour disponible avec différentes finitions tendance · surface thermolaquée · on/off ou dimmable DALI

LORA 1 PD

CODE	SYS W	LUMEN
176-10201000WWXXY	10	570

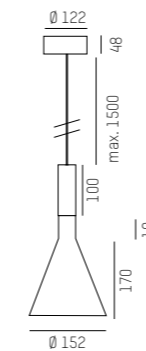

LORA 2 PD

CODE	SYS W	LUMEN
176-10202000WWXXY	10	680

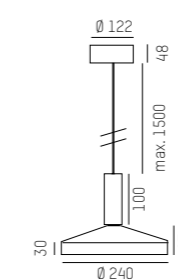

LORA 3 PD

CODE	SYS W	LUMEN
176-10203000WWXXY	10	700

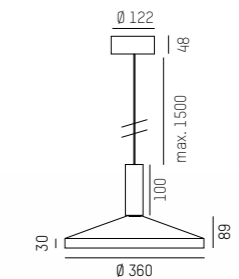

LORA 4 PD

CODE	SYS W	LUMEN
176-10204000WWXXY	10	690

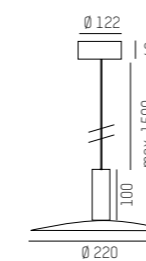

LORA 5 PD

CODE	SYS W	LUMEN
176-10205000WWXXY	10	690

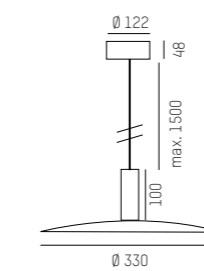

COMPLETE CODE			
WW = LIGHT COLOUR	X = COLOUR LUMINAIRE	X = COLOUR SHADE	Y = DIMMABLE
w2 LED 2700K = 23 CRI>90	w white = 5	w white = 5	s switchable = 0
w3 LED 3000K = 29 CRI>90	s black = 6	s black = 6	d DALI dim = d



DARK NIGHT



Hotel Essigmanngut, Anif, Austria, Photo: Joachim Rauch



Hotel Pierer, Fladnitz, Austria, Photo: Joachim Rauch



Private residence, Austria, Planing: Leibets Interior Design, Photo: Foto Stöbich



Carpe Diem, Linz, Austria, Photo: Joachim Rauch



Private residence, Austria, Planing: Leibets Interior Design, Photo: Foto Stöbich



HP Ingenieure, Geretsried - Gelting, Germany
Photo: www.hp-ingenieure.com, ©Jan Greune



BFI, Linz, Austria
Photo: Joachim Rauch

DARK NIGHT

THE PERFECT VARIETY

Die variantenreiche Produktfamilie DARK NIGHT besticht durch ihre Anpassungsfähigkeit, als starrer oder schwenkbarer Downlight, Hängeleuchte mit Baldachin oder VOLARE Adapter bis zum Aufbaudownlight. Das Produkthighlight DARK NIGHT LGP eröffnet durch die separate Steuerung von diffusem und gerichtetem Licht aus einer Leuchte neue Möglichkeiten in der Inszenierung von Räumen. Die DARK NIGHT Familie ist in schwarz und weiß pulverbeschichteten Gehäusen und Reflektoren in Schwarz Hochglanz, Silber Matt, weiß und Gold erhältlich.

The varied product family DARK NIGHT impresses with its adaptability, from fixed or swivelling downlight to pendant luminaire with canopy or VOLARE adapter through to surface mounted downlight. The product highlight DARK NIGHT LGP opens up completely possibilities in the staging of rooms through the separate control of diffuse and directed light from one luminaire. The DARK NIGHT family is available in black and white powder-coated housings and reflectors in high-gloss black, matt silver, white and gold.

Design: INHOUSE

VARIATIONS

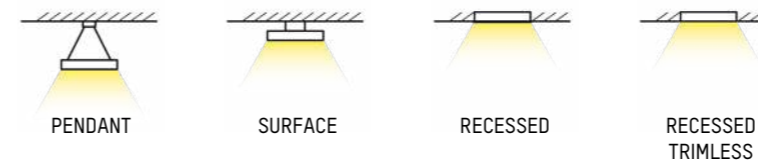

LED COLOURS



COLOURS



REFLECTOR COLOURS



SPECIAL DARK NIGHT LGP SDI

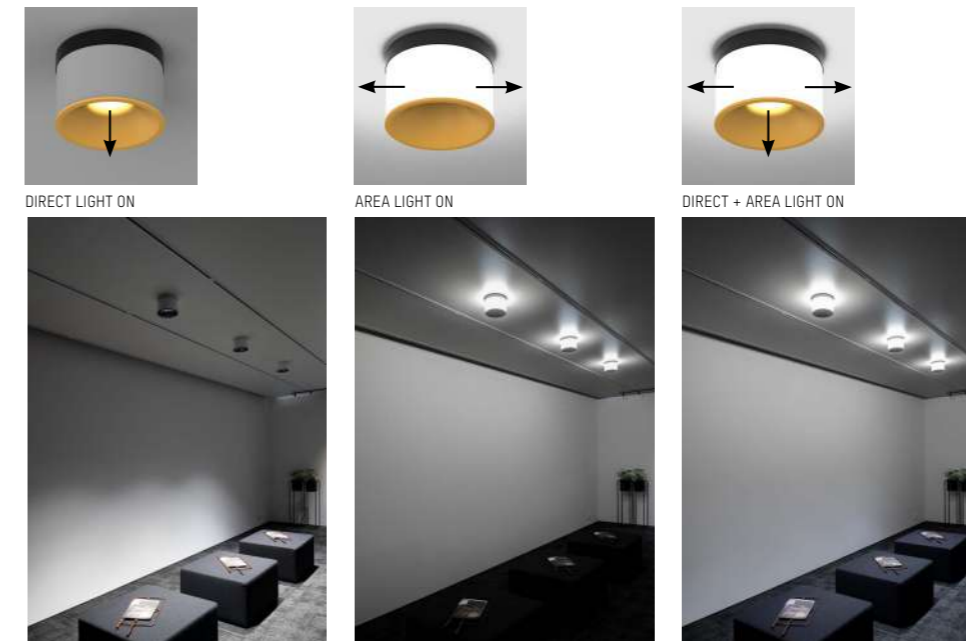



Private residence, Austria, Photo: Joachim Rauch

DARK NIGHT LGP SDI

DARK NIGHT LGP SDI

IP20

220-240V AC 50/60Hz UGR<19 Design: INHOUSE

Aufbauleuchte aus Aluminium · perfekt entblendetes Direktlicht · homogen und breit abstrahlendes Indirektlicht · getrennt schalt- bzw. dimmbar
 Surface mounted luminaire · perfectly glare-free direct light · homogeneous and wide beam indirect light · separately switchable and dimmable
 Lampada a soffitto · luce diretta anti-abbagliamento · luce indiretta omogenea ed a fascio largo grazie · controllabile separatamente (on-off) · o dimmerabile
 Plafonnier en aluminium · émission lumineuse directe particulièrement · émission lumineuse indirecte homogène · contrôlables et dimmables séparément

CODE	SYS W	LUMEN
706-010RR55WWXXY	40	3010 - 3580

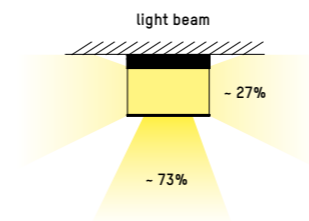
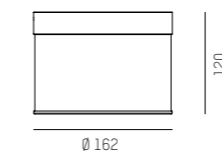

COMPLETE CODE			
RR = REFLECTOR	WW = LIGHT COLOUR	XX = COLOUR	Y = DIMMABLE
<ul style="list-style-type: none"> 40° medium = 02 40° medium = 03 40° medium = 04 40° medium = 06 	<ul style="list-style-type: none"> LED 2700K = 43 PREMIUM CRI>90 LED 3000K = 49 PREMIUM CRI>90 LED 4000K = 24 CRI>90 	<ul style="list-style-type: none"> white = 05 black = 06 	<ul style="list-style-type: none"> switchable = 0 CASAMBI dim = c DALI dim = d ZIGBEE dim = z



Hotel Bergeblick, Bad Tölz, Germany, Photo: Joachim Rauch

DARK NIGHT SD

DARK NIGHT TURN SD

IP20

220-240V AC 50/60Hz UGR<16 / UGR< 19 Design: INHOUSE

LED Deckenaufbauleuchte aus Aluminium · Oberfläche pulverbeschichtet · in 2 Farben erhältlich · perfekte Entblendung · schwenkbar
 LED surface mounted ceiling luminaire in aluminium · surface powder-coated · available in 2 colours · perfect glare control · swivelling
 Lampada LED a plafone in alluminio · superficie verniciata a polvere · disponibile in 2 colori · perfetto controllo dell'abbagliamento · girevole
 Plafonnier LED en aluminium · surface thermolaquée · disponible en 2 couleurs · anti-éblouissement · pivotant

DARK NIGHT TURN XS SD

CODE	SYS W	LUMEN
527-0009RR0BWWXX0	9	600

nicht dimmbar / not dimmable

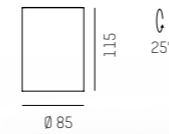

DARK NIGHT TURN S SD

CODE	SYS W	LUMEN
527-0010RR0BWWXXY	13	810

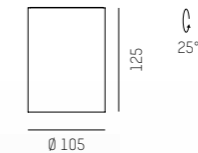

COMPLETE CODE				
RR = REFLECTOR	B = BEAM ANGLE	WW = LIGHT COLOUR	XX = COLOUR	Y = DIMMABLE
= 02	40° = 3	LED 2700K = 43 PREMIUM CRI>90	white = 05	switchable = 0
= 03	60° = 4	LED 3000K = 49 PREMIUM CRI>90	black = 06	DALI dim = d
= 04		LED 4000K = 24 CRI>90		
= 06				

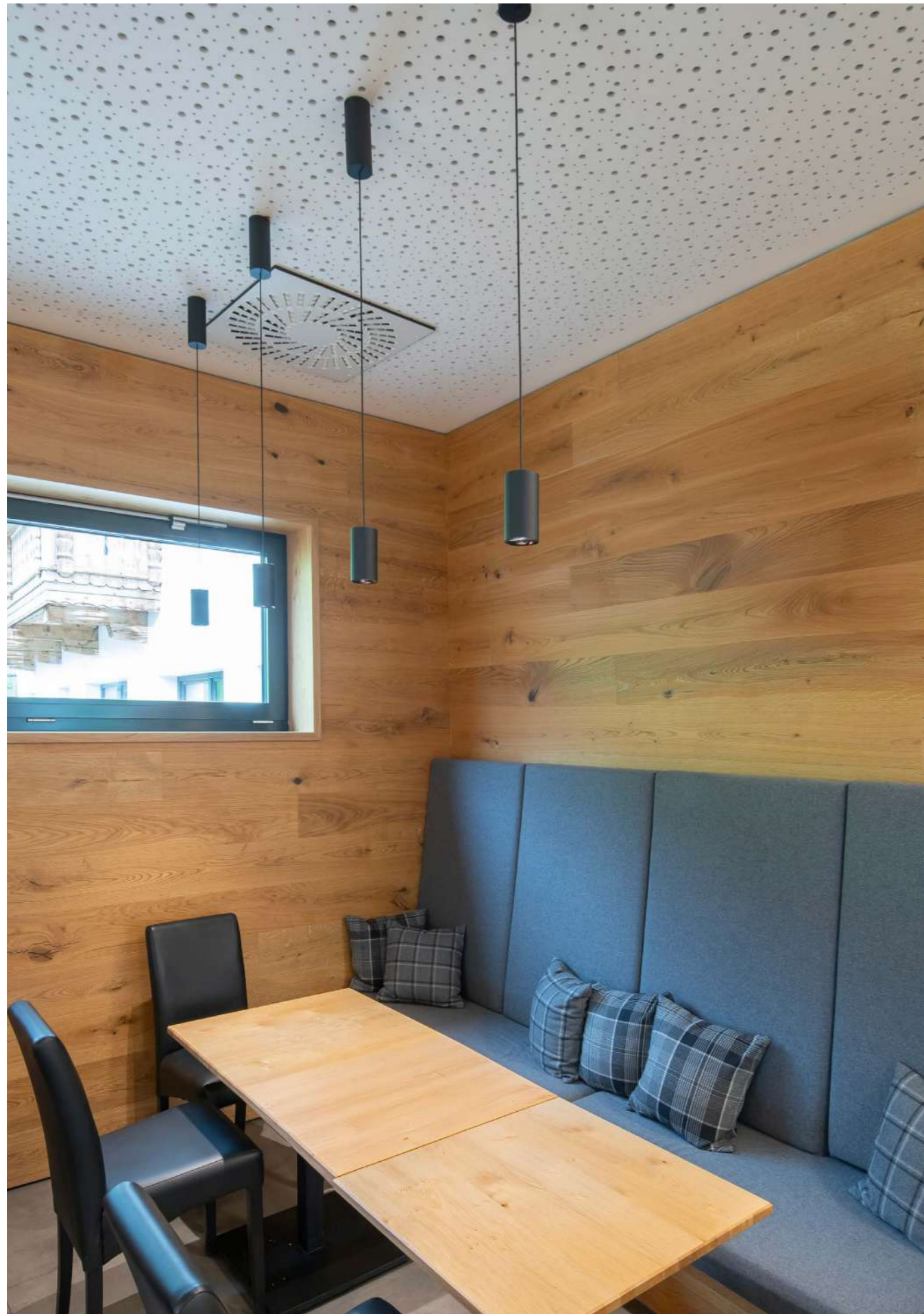

N'Cyan – Innovation für Menschen, St. Jakob in Deferegggen, Austria, Photo: Joachim Rauch

DARK NIGHT PD

IP20

DARK NIGHT XS PD

220-240V AC 50/60Hz Design: INHOUSE UGR<19

Pendelleuchte aus Aluminium · Oberfläche pulverbeschichtet · perfekte Entblendung durch zurückversetztem Reflektor

Pendant in aluminium · surface powder-coated · perfect glare control due to recessed reflector

Sospensione in alluminio · superficie verniciata a polveri · controllo anti-abbagliamento grazie al riflettore retrocesso

Suspension en aluminium · surface laquée en poudre · contrôle anti-éblouissement grâce à un réflecteur rétro-réfléchissant

CODE	SYS W	LUMEN
684-006RR0BWWXXYv1	20 - 22	1420 - 1740

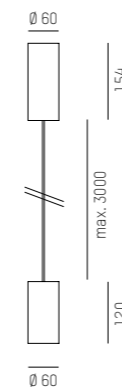

KABELHALTER / CABLE HOLDER

CODE

305-0001



COMPLETE CODE

RR = REFLECTOR	B = BEAM ANGLE	WW = LIGHT COLOUR	XX = COLOUR	Y = DIMMABLE
<ul style="list-style-type: none"> = 02 = 03 = 04 = 06 	<ul style="list-style-type: none"> 40° = 5 60° = 8 	<ul style="list-style-type: none"> LED 2700K = 43 PREMIUM CRI>90 LED 3000K = 49 PREMIUM CRI>90 LED 4000K = 24 CRI>90 	<ul style="list-style-type: none"> white = 55 black = 66 	<ul style="list-style-type: none"> switchable = 0 DALI dim = d





Wiesner & Hager, Graz, Austria, Photo: Joachim Rauch

DARK NIGHT TURN R

DARK NIGHT TURN R

IP20

220-240V AC 50/60Hz Design: INHOUSE UGR<19 (Dark Night XS) / UGR<16 (Dark Night SMALL)

Downlight aus Aluminium · Oberfläche pulverbeschichtet · perfekte Entblendung durch zurückversetztem Reflektor · excl. Konverter
 Downlight in aluminium · surface powder-coated · perfect glare control due to recessed reflector · excl. driver
 Proiettore ad incasso · superficie verniciata a polveri · controllo anti-abbagliamento grazie al riflettore retrocesso · excl. driver
 Downlight · surface laquée en poudre · contrôle anti-éblouissement grâce à un réflecteur rétro-réfléchissant · excl. convertisseur

DARK NIGHT TURN XS R

CODE	LED W / mA	LUMEN
684-004RR0BWWXXv1	9 / 250 13 / 350	780 - 960 1010 - 1280

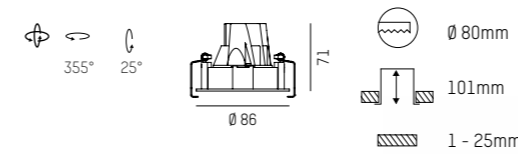

DARK NIGHT TURN SMALL R

CODE	LED W / mA	LUMEN
684-005RR0BWWXXv1	13 / 350 19 / 500	1000 - 1230 1370 - 1680

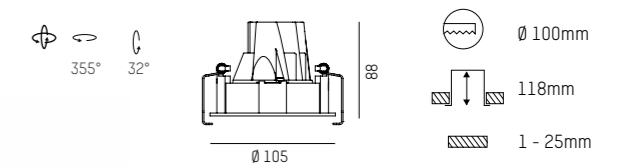

LED CONVERTER	mA	DIM	FOR
30-880006	250 - 350lm	not dimmable	1 x DARK NIGHT 9 - 13W
30-880106	500	not dimmable	1 x DARK NIGHT 19W
24-151403	250 - 500	DALI dimmable	1 x DARK NIGHT 9 - 19W
700-3004	250 - 500	CASAMBI dimmable	1 x DARK NIGHT 9 - 19W

XS



SMALL



COMPLETE CODE			
RR = REFLECTOR	B = BEAM ANGLE	WW = LIGHT COLOUR	XX = COLOUR
<ul style="list-style-type: none"> = 02 = 03 = 04 = 06 	<ul style="list-style-type: none"> = 5 = 8 	<ul style="list-style-type: none"> LED 2700K = 43 PREMIUM CRI>90 LED 3000K = 49 PREMIUM CRI>90 LED 4000K = 24 CRI>90 	<ul style="list-style-type: none"> white = 55 black = 66

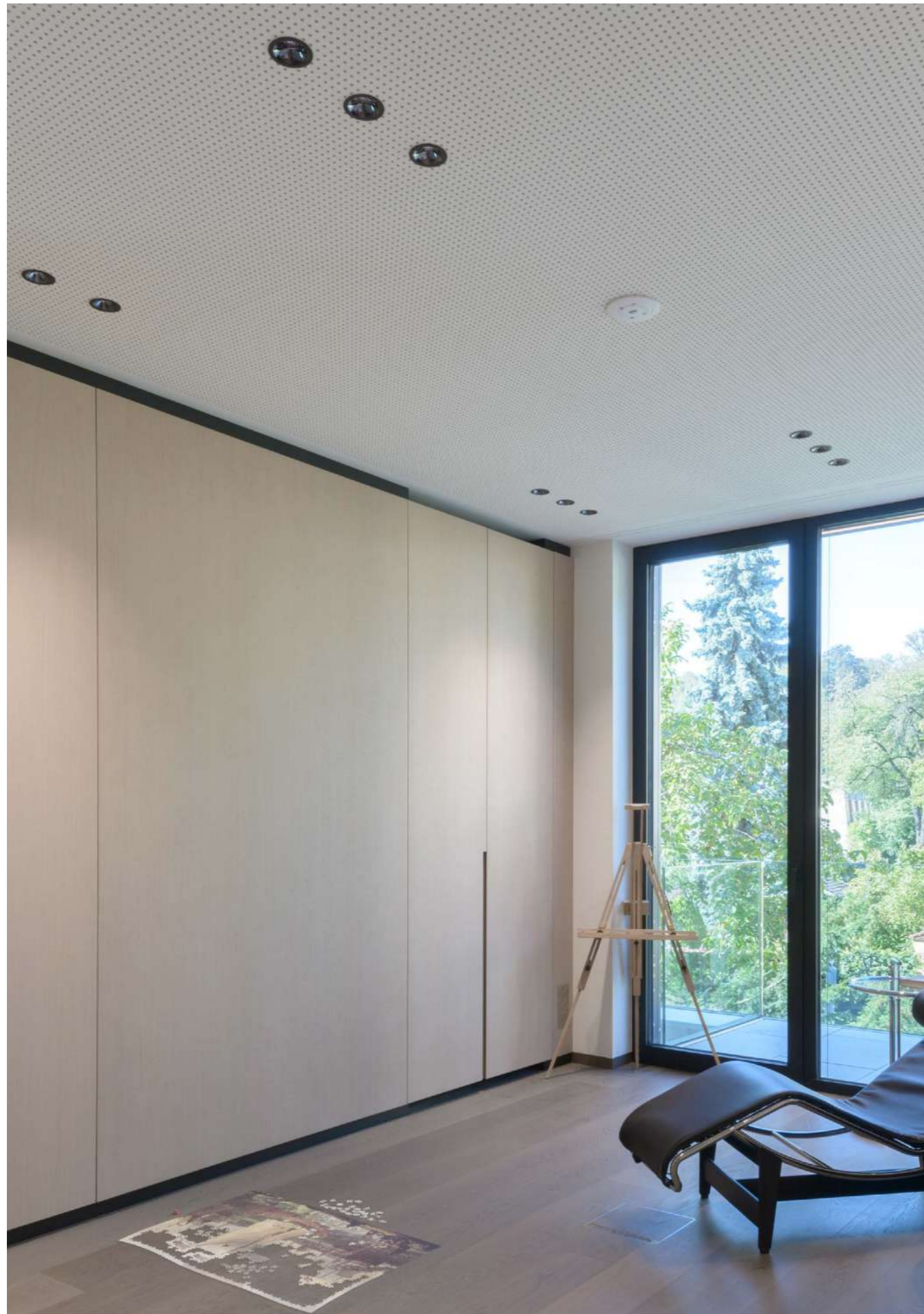

Private Living, Austria, Photo: Simon Bauer, www.plan9.at

DARK NIGHT R

IP20

DARK NIGHT R

220-240V AC 50/60Hz Design: INHOUSE UGR<19 (Dark Night XS) / UGR<16 (Dark Night SMALL)

Downlight aus Aluminium · Oberfläche pulverbeschichtet · perfekte Entblendung durch zurückversetztem Reflektor · exkl. Konverter
 Downlight in aluminium · surface powder-coated · perfect glare control due to recessed reflector · excl. driver
 Proiettore ad incasso · superficie verniciata a polveri · controllo anti-abbagliamento grazie al riflettore retrocesso · excl. driver
 Downlight · surface laquée en poudre · contrôle anti-éblouissement grâce à un réflecteur rétro-réfléchissant · excl. convertisseur

DARK NIGHT XS R

CODE	LED W / mA	LUMEN
684-003RR0BWWXXv1	9 / 250	780 - 960
	13 / 350	1040 - 1280

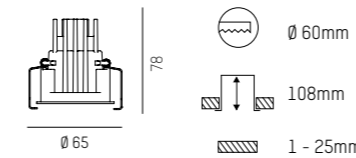

RECESSED FRAME SQUARE FOR
 684-000031000XXv1 DARK NIGHT XS R

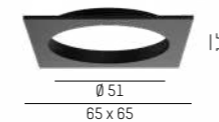

DARK NIGHT SMALL R

CODE	LED W / mA	LUMEN
684-001RR0BWWXXv1	13 / 350	1000 - 1230
	19 / 500	1370 - 1680

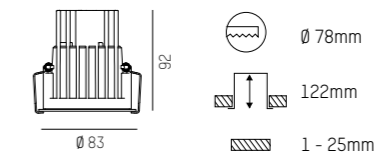

RECESSED FRAME SQUARE FOR
 684-000011000XXv1 DARK NIGHT SMALL R



COVER RING FOR DARK NIGHT XS R

684-00XX

screwable for ceiling cutout Ø 68mm



LED CONVERTER	mA	DIM	FOR
30-880006	250 - 350lm	not dimmable	1 x DARK NIGHT 9 - 13W
30-880106	500	not dimmable	1 x DARK NIGHT 19W
24-151403	250 - 500	DALI dimmable	1 x DARK NIGHT 9 - 19W
700-3004	250 - 500	CASAMBI dimmable	1 x DARK NIGHT 9 - 19W

XS



SMALL



COMPLETE CODE			
RR = REFLECTOR	B = BEAM ANGLE	WW = LIGHT COLOUR	XX = COLOUR
= 02	40° = 5	LED 2700K = 43 PREMIUM CRI>90	white = 05
= 03	60° = 8	LED 3000K = 49 PREMIUM CRI>90	black = 06
= 04		LED 4000K = 24 CRI>90	
= 06			

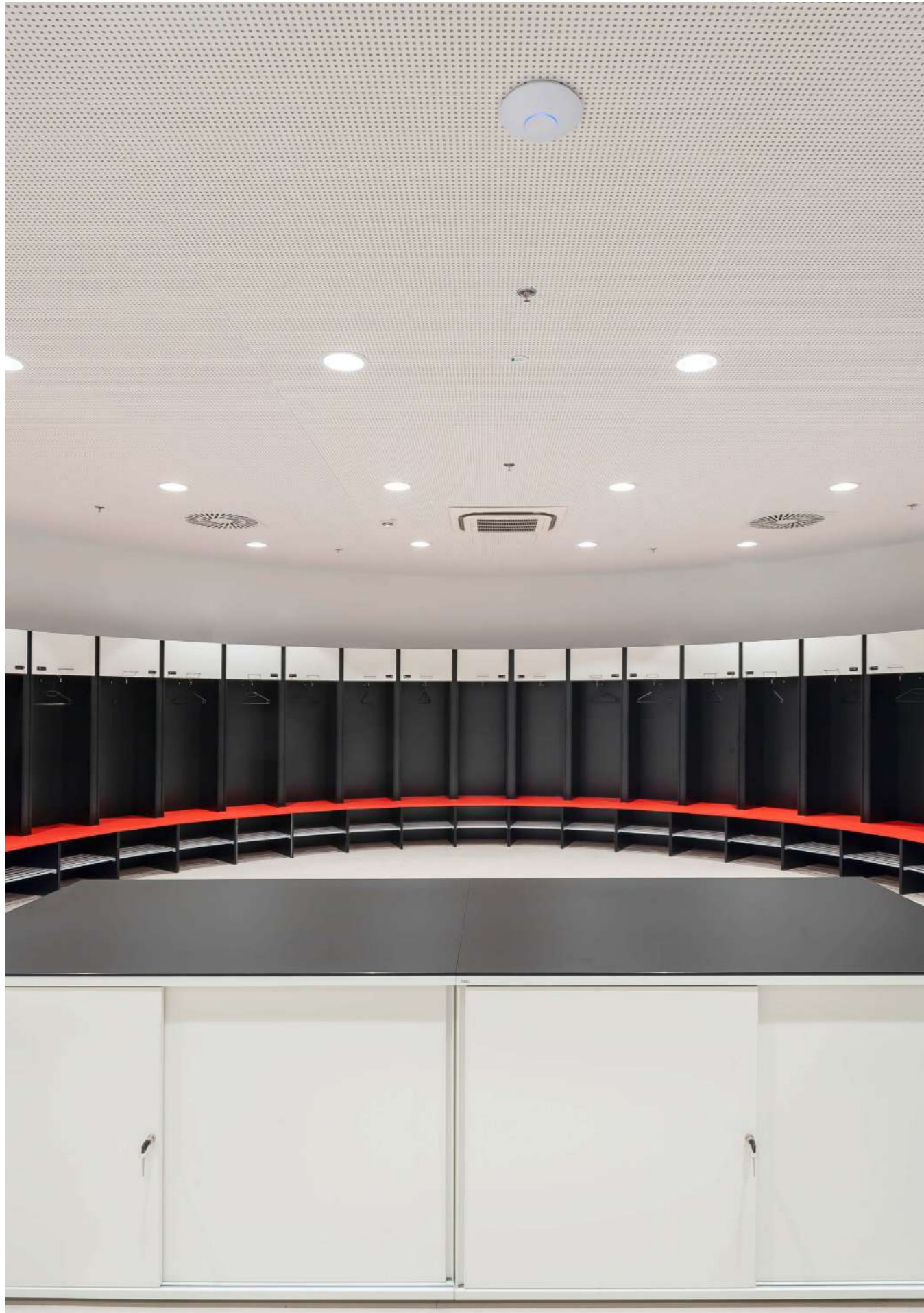

Raiffeisen Arena, Linz, Austria, Photo: Joachim Rauch

DARK NIGHT R

DARK NIGHT MEDIUM R

220-240V AC 50/60Hz Design: INHOUSE UGR<16

IP20

Downlight aus Aluminium · Oberfläche pulverbeschichtet · perfekte Entblendung durch zurückversetztem Reflektor · excl. Konverter
 Downlight in aluminium · surface powder-coated · perfect glare control due to recessed reflector · excl. driver
 Proiettore ad incasso · superficie verniciata a polveri · controllo anti-abbagliamento grazie al riflettore retrocesso · excl. driver
 Downlight · surface laquée en poudre · contrôle anti-éblouissement grâce à un réflecteur rétro-réfléchissant · excl. convertisseur

CODE	LED W / mA	LUMEN
	18 / 500	1950 - 2240
684-002RR05WWXXv1	25 / 700	2620 - 3020
	33 / 900	3230 - 3720

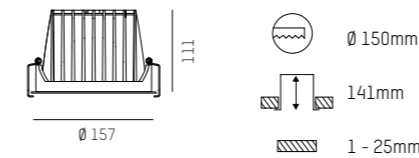

LED CONVERTER	mA	DIM	FOR
30-880106	500 - 700	not dimmable	1 x DARK NIGHT 18-25W
24-127536n	900	not dimmable	1 x DARK NIGHT 33W
24-127490	500 - 900	DALI dimmable	1 x DARK NIGHT 18 - 33W
700-3004	500 - 900	CASAMBI dimmable	1 x DARK NIGHT 18 - 33W



COMPLETE CODE		
RR = REFLECTOR	WW = LIGHT COLOUR	XX = COLOUR
40° medium = 02	LED 2700K = 43 PREMIUM CRI>90	white = 05
40° medium = 03	LED 3000K = 49 PREMIUM CRI>90	black = 06
40° medium = 04	LED 4000K = 24 CRI>90	
40° medium = 06		

DARK NIGHT S R TRIMLESS

Die Produktfamilie Dark Night von Molto Luce bekommt eine beeindruckende Erweiterung durch die Einführung rahmenloser Einbaustrahler. Die minimalistische Gestaltung verleiht dem Strahler eine zeitlose Eleganz und ermöglicht eine nahtlose Integration in verschiedenste Raumkonzepte. Der Verzicht auf einen sichtbaren Rahmen lenkt den Fokus auf das Wesentliche – das Licht selbst. Ein weiteres herausragendes Feature ist die Möglichkeit, die Einbaurahmen mittels Klicktechnik miteinander zu verbinden. Dies ermöglicht eine flexible Gestaltung von Lichtinstallationen und schafft eine beeindruckende Gesamtwirkung. Mit einer hohen Lichtleistung bieten sie eine hervorragende Beleuchtung für verschiedene Anwendungen, sei es in Wohnräumen, Geschäftsgebäuden oder öffentlichen Bereichen.

The Dark Night product family from Molto Luce receives an impressive expansion with the introduction of trimless recessed spotlights. The minimalist design imparts a timeless elegance to the spotlight and allows for seamless integration into various room concepts. The absence of a visible frame directs the focus to the essential – the light itself. Another outstanding feature is the ability to connect the recessed frames using a click system. This enables flexible design of lighting installations and creates an impressive overall effect. With high light output, they offer excellent illumination for various applications, whether in residential spaces, commercial buildings, or public areas.



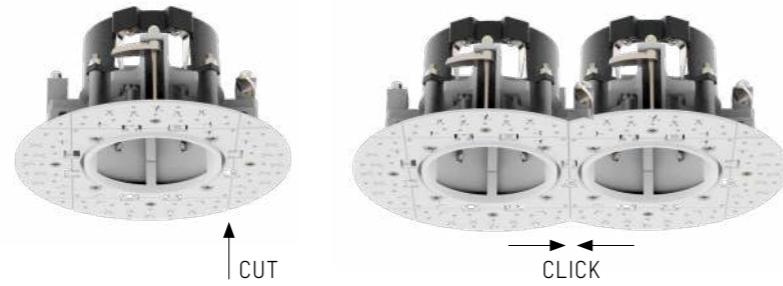

Der innovative Einbaurahmen für Dark Night S R und S Turn R ermöglicht ein müheloses Verbinden durch einfaches Abtrennen der vorgestanzten Rahmenelemente. Diese flexible Konstruktion erlaubt eine stabile Verbindung mit anderen Einbaurahmen, um eine anpassbare und leicht installierbare Beleuchtungslösung zu schaffen. Ein durchdachtes Design, das Benutzerfreundlichkeit und Vielseitigkeit in der Anwendung vereint.

The innovative recessed frame for Dark Night S R and S R Turn R allows for effortless connection by simply detaching the pre-perforated frame elements. This flexible construction permits a stable connection with other recessed frames, creating a customizable and easy-to-install lighting solution. A well-thought-out design that combines user-friendliness and versatility in application.

EASY CLICK SYSTEM

OPTIONS

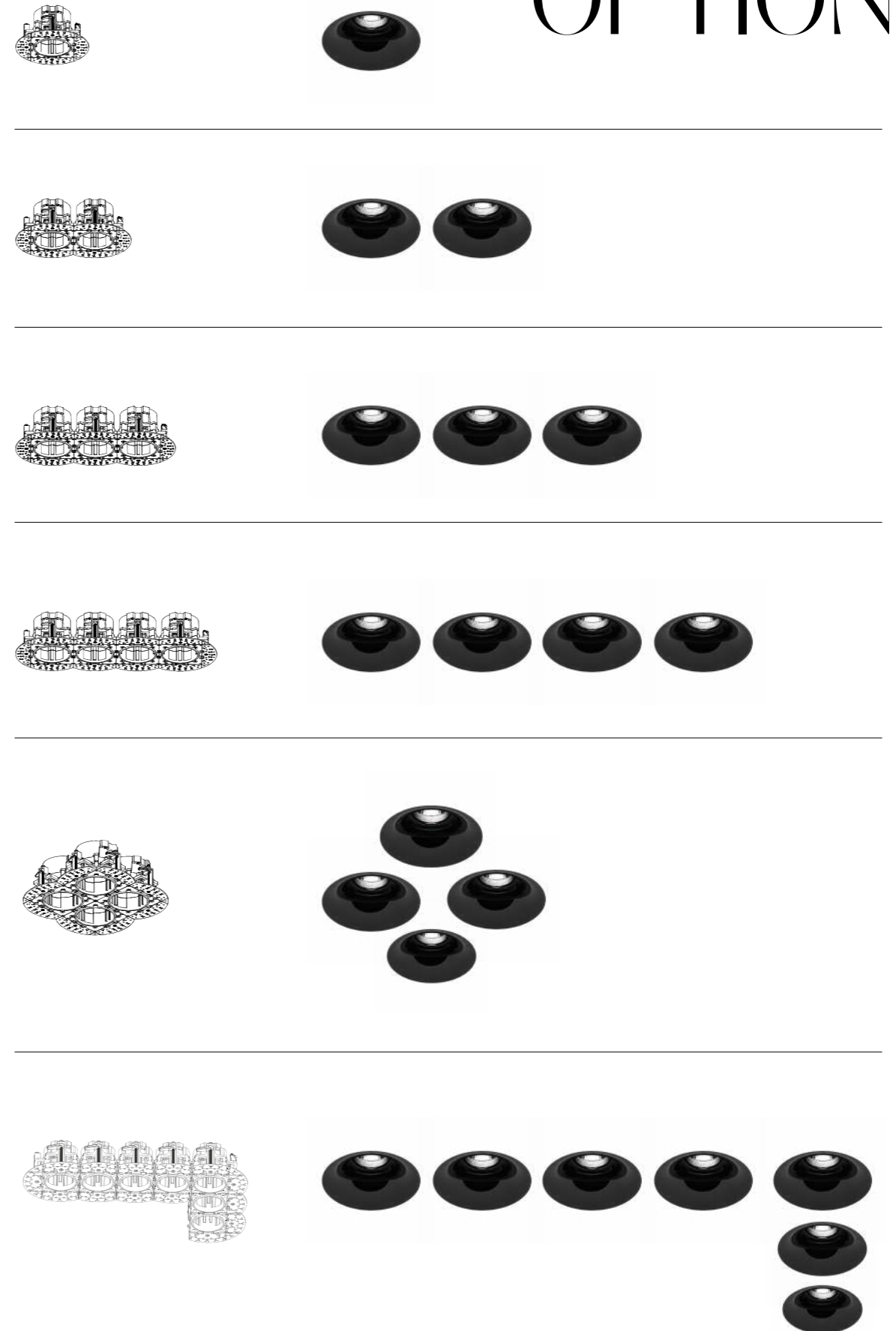



MOUNTING INSTRUCTIONS



Deckenloch ausschneiden und Einbaurahmen mittels höhenverstellbaren Halteklammern fixieren. Konverter bei vorgesehener Ausnehmung des Einbaurahmens in die Decke einlegen.

Cut a ceiling hole and fix the recessed frame using height-adjustable retaining clips. Insert the converter into the ceiling at the designated recess of the recessed frame.



Decke spachteln und malen. Vor dem Einbau des Strahlers Malerschutz abnehmen.

Fill and paint the ceiling. Remove the paint protection before installing the spotlight.



Dark Night S und S Turn R am Konverter anschließen und die Absturzsicherung am Strahlergehäuse einhängen.

Connect Dark Night S and S Turn R with the converter and attach the strain relief to the spotlight housing.

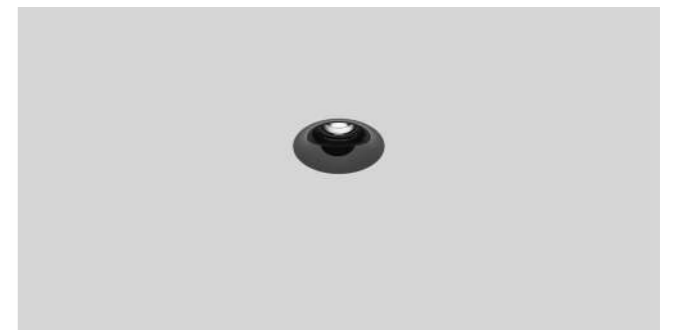

Strahler in die Führungsschienen des Gehäuses einsetzen und werkzeuglos mittels Federtechnologie in das Gehäuse einklicken. Die Demontage erfolgt durch leichtes Drücken des Strahlers rein in die Decke – dadurch entriegelt sich der Federmechanismus.

Insert the spotlight into the guide rails of the housing and click it into place tool-free using spring technology. To remove, gently press the spotlight further into the ceiling to unlock the spring mechanism.



DARK NIGHT TURN R

DARK NIGHT TURN S MODUL R TRIMLESS

IP20

220-240V AC 50/60Hz UGR<16 Design: INHOUSE

Downlight aus Aluminium · Oberfläche pulverbeschichtet · perfekte Entblendung durch zurückversetztem Reflektor · exkl. Konverter
 Downlight in aluminium · surface powder-coated · perfect glare control due to recessed reflector · excl. driver
 Proiettore ad incasso · superficie verniciata a polveri · controllo anti-abbagliamento grazie al riflettore retrocesso · excl. driver
 Downlight · surface laquée en poudre · contrôle anti-éblouissement grâce à un réflecteur rétro-réfléchissant · excl. convertisseur

CODE	LED W / mA	LUMEN
684-009RR0BWWXXv1	13 / 350	1100 - 1200
	19 / 450	1340 - 1460

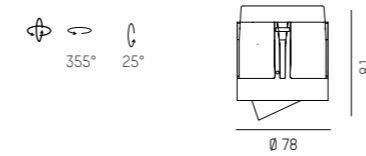

EINBAURAHMEN RAHMENLOS RECESSED FRAME TRIMLESS

684-01105v2

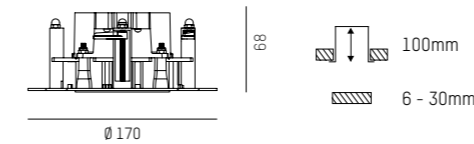

LED CONVERTER	mA	DIM	FOR
30-880006	350 - 450	not dimmable	1 x DARK NIGHT S 13 - 19W
24-151403	250 - 500	DALI dimmable	1 x DARK NIGHT S 13 - 19W
700-3004	250 - 500	CASAMBI dimmable	1 x DARK NIGHT S 13 - 19W

SPOT



FRAME



COMPLETE CODE			
RR = REFLECTOR	B = BEAM ANGLE	WW = LIGHT COLOUR	XX = COLOUR
<ul style="list-style-type: none"> = 02 = 03 = 04 = 06 	<ul style="list-style-type: none"> 40° = 5 60° = 8 	<ul style="list-style-type: none"> LED 2700K = 43 PREMIUM CRI>90 LED 3000K = 49 PREMIUM CRI>90 LED 4000K = 24 CRI>90 	<ul style="list-style-type: none"> white = 05 black = 06

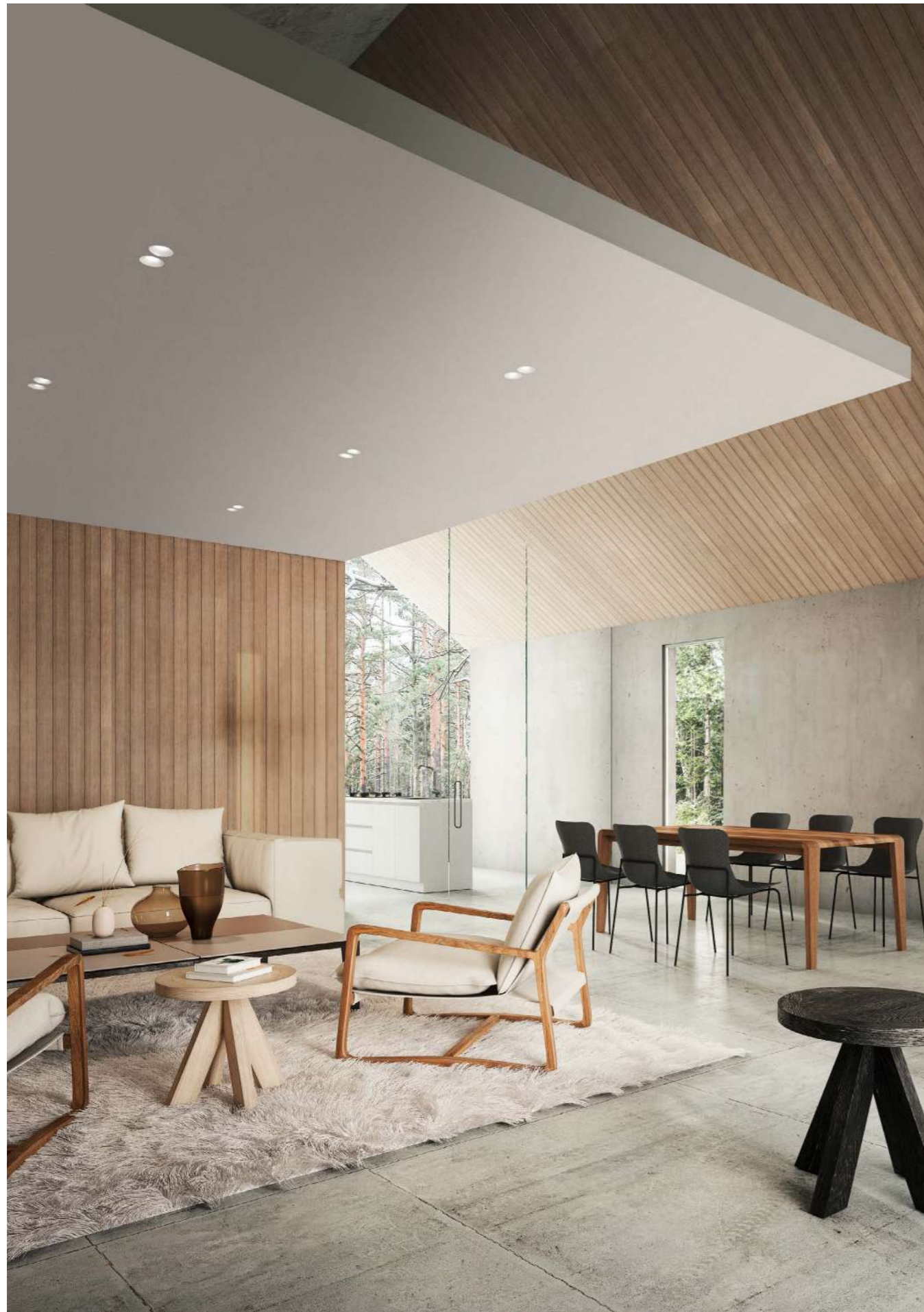

DARK NIGHT R

DARK NIGHT S MODUL R TRIMLESS

IP20

220-240V AC 50/60Hz UGR<16 Design: INHOUSE

Downlight aus Aluminium · Oberfläche pulverbeschichtet · perfekte Entblendung durch zurückversetztem Reflektor · exkl. Konverter
 Downlight in aluminium · surface powder-coated · perfect glare control due to recessed reflector · excl. driver
 Proiettore ad incasso · superficie verniciata a polveri · controllo anti-abbagliamento grazie al riflettore retrocesso · excl. driver
 Downlight · surface laquée en poudre · contrôle anti-éblouissement grâce à un réflecteur rétro-réfléchissant · excl. convertisseur

CODE	LED W / mA	LUMEN
684-008RR0BWW06v1	13 / 350	1100 - 1190
	17 / 450	1340 - 1460

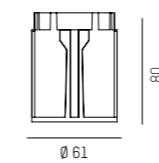

EINBAURAHMEN RAHMENLOS RECESSED FRAME TRIMLESS

684-01005v2

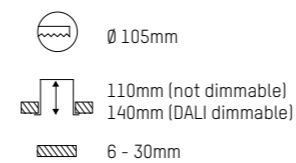
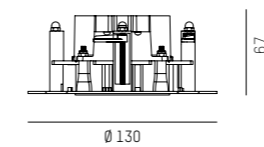

LED CONVERTER	mA	DIM	FOR
30-880006	350 - 450	not dimmable	1 x DARK NIGHT S 13 - 19W
24-151403	250 - 500	DALI dimmable	1 x DARK NIGHT S 13 - 19W
700-3004	250 - 500	CASAMBI dimmable	1 x DARK NIGHT S 13 - 19W



SPOT



FRAME



COMPLETE CODE

RR = REFLECTOR	B = BEAM ANGLE	WW = LIGHT COLOUR
= 02	40° = 5	LED 2700K = 43 PREMIUM CRI>90
= 03	60° = 8	LED 3000K = 49 PREMIUM CRI>90
= 04		LED 4000K = 24 CRI>90
= 06		

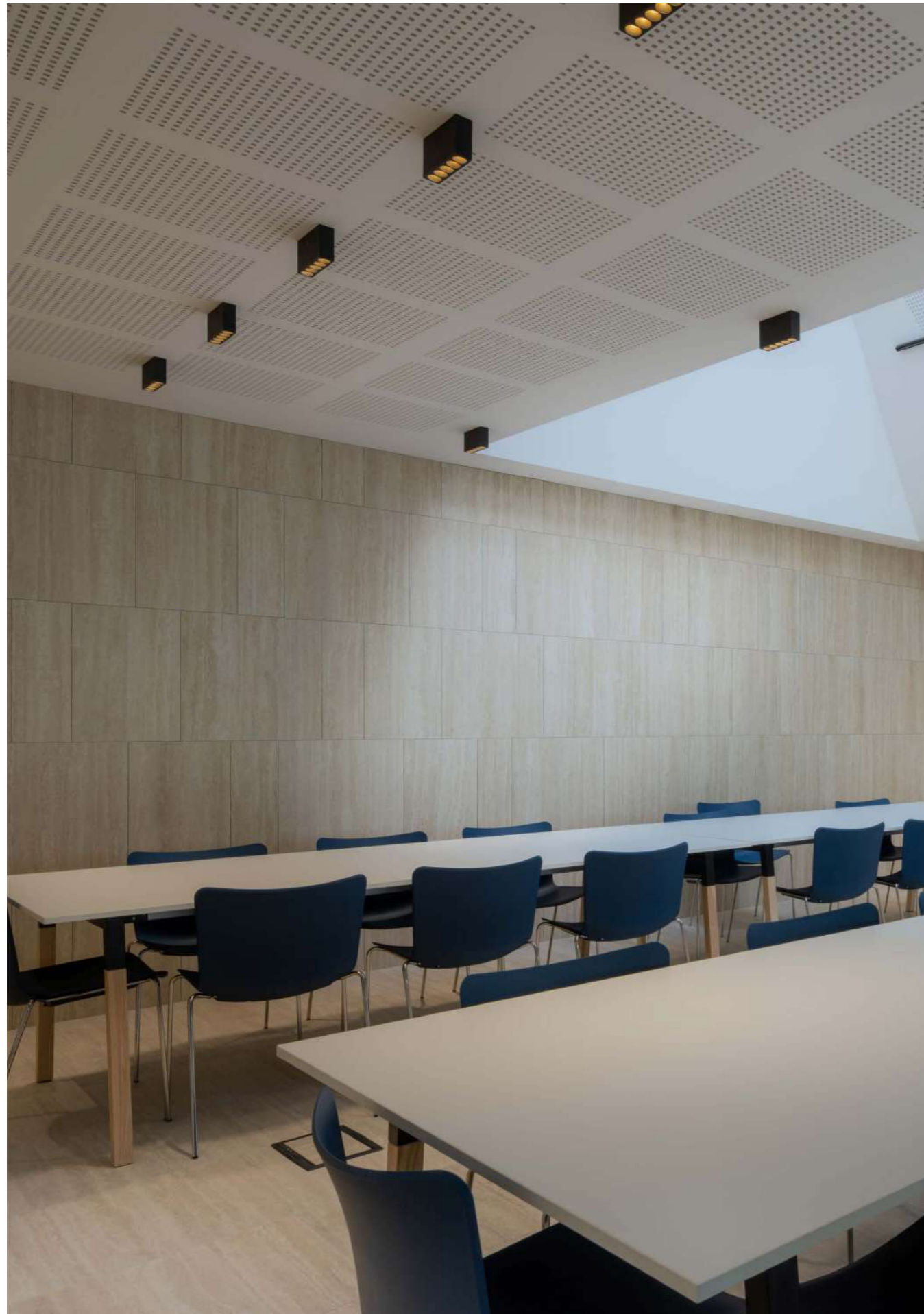

Ristrutturazione nuova sede Tyrolit, Bassano del Grappa, Italy, Photo: Marco Zanta

DARK NIGHT LENS SD

DARK NIGHT LENS SD

220-240V AC 50/60Hz Design: INHOUSE UGR<16

IP20

Downlight aus Aluminium · Oberfläche pulverbeschichtet · perfekte Entblendung durch zurückversetzter Linsenoptik · inkl. Konverter
 Downlight in aluminium · surface powder-coated · Perfect glare control due to recessed lens optics · incl. converter
 Proiettore in alluminio · superficie verniciata a polveri · controllo anti-abbagliamento grazie al ottica a lente · incl. driver
 Downlight en aluminium · surface laquée en poudre · contrôle anti-éblouissement grâce à un optique à lentilles rétro-réfléchissant · incl. convertisseur

DARK NIGHT LENS 3 SD

CODE	SYS W	LUMEN
579-004RR0BWWXX0	7	450 - 580

nicht dimmbar / not dimmable

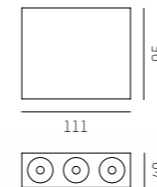

LENS 3



DARK NIGHT LENS 5 SD

CODE	SYS W	LUMEN
579-005RR0BWWXXY	12	700 - 920

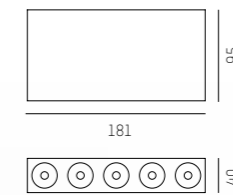
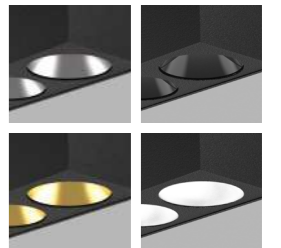

LENS 5



COMPLETE CODE				
RR = REFLECTOR	B = BEAM ANGLE	WW = LIGHT COLOUR	XX = COLOUR	Y = DIMMABLE
<ul style="list-style-type: none"> = 02 = 03 = 04 = 06 	<ul style="list-style-type: none"> 22° = 5 36° = 8 	<ul style="list-style-type: none"> LED 2700K = 23 CRI>90 LED 3000K = 29 CRI>90 LED 4000K = 24 CRI>90 	<ul style="list-style-type: none"> white = 05 black = 06 	<ul style="list-style-type: none"> switchable = 0 DALI dim = d



DARK NIGHT LENS R

DARK NIGHT LENS R

IP20

220-240V AC 50/60Hz Design: INHOUSE UGR<16

Downlight aus Aluminium · Oberfläche pulverbeschichtet · perfekte Entblendung durch zurückversetzter Linsenoptik · inkl. Konverter
 Downlight in aluminium · surface powder-coated · Perfect glare control due to recessed lens optics · incl. converter
 Proiettore in alluminio · superficie verniciata a polveri · controllo anti-abbagliamento grazie al ottica a lente · incl. driver
 Downlight en aluminium · surface laquée en poudre · contrôle anti-éblouissement grâce à un optique à lentilles rétro-réfléchissant · incl. convertisseur

DARK NIGHT LENS 2 R

CODE	LED W / mA	LUMEN
579-001RR0BWWXX	6 / 1050	400 - 530

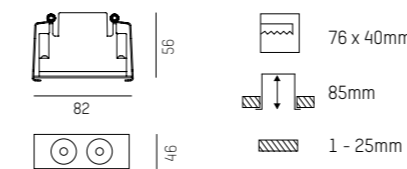

DARK NIGHT LENS 3 R

CODE	LED W / mA	LUMEN
579-002RR0BWWXXY	9 / 1050	600 - 810

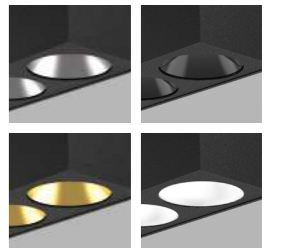
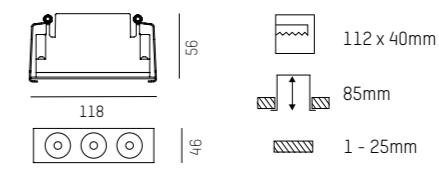

DARK NIGHT LENS 5 R

CODE	LED W / mA	LUMEN
579-003RR0BWWXXY	16 / 1050	930 - 1230

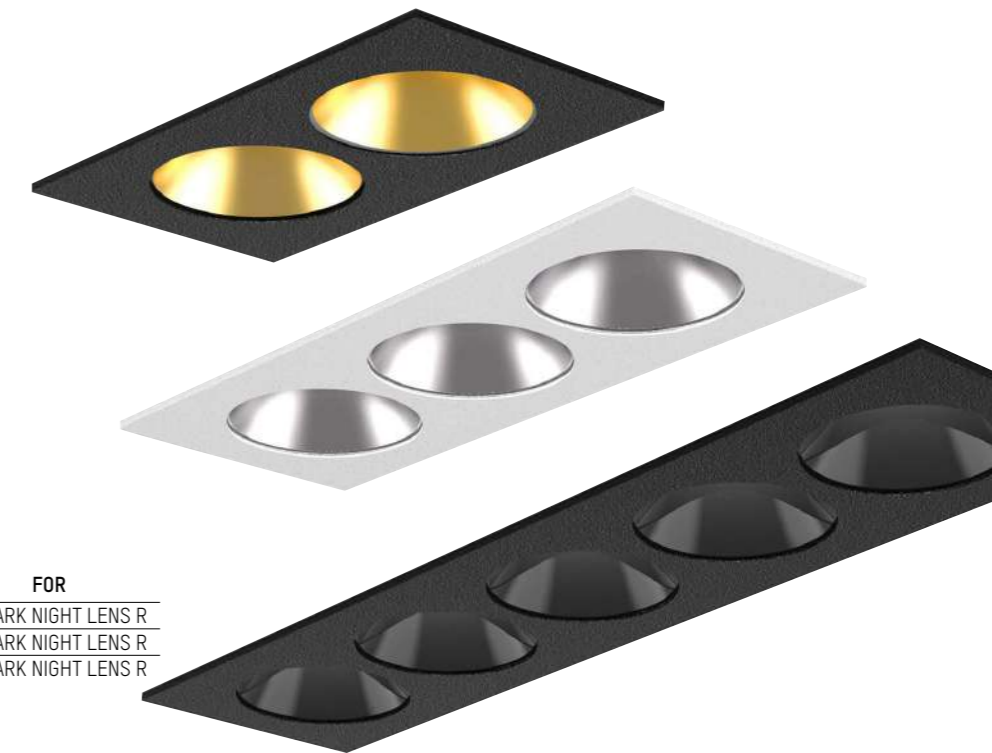
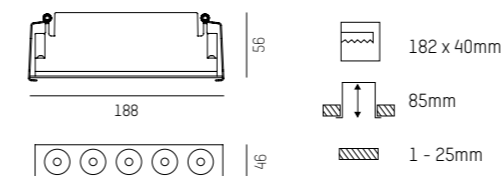

LED CONVERTER	mA	DIMM	FOR
30-880206	1050	not dimmable	1 x DARK NIGHT LENS R
24-127490	1050	DALI dimmable	1 x DARK NIGHT LENS R
700-3004	1050	CASAMBI dimmable	1 x DARK NIGHT LENS R



COMPLETE CODE				
RR = REFLECTOR	B = BEAM ANGLE	WW = LIGHT COLOUR	XX = COLOUR	Y = DIMMABLE
<ul style="list-style-type: none"> = 02 = 03 = 04 = 06 	<ul style="list-style-type: none"> 22° = 5 36° = 8 	<ul style="list-style-type: none"> LED 2700K = 23 CRI>90 LED 3000K = 29 CRI>90 LED 4000K = 24 CRI>90 	<ul style="list-style-type: none"> white = 05 black = 06 	<ul style="list-style-type: none"> switchable = 0 DALI dim = d



COZY R

COZY R
24 V DC

50/60Hz

Design: Serge Cornelissen

IP20

Einbaudownlight aus Aluminium mit 2 getrennt schaltbaren Lichtkreisen · Hauptlichtquelle für fokussiertes Licht und zweite Lichtquelle für stimmungsvolles Grundlicht · schaltbar oder DALI dimmbar · exkl. Konverter
 Recessed downlight in aluminium with 2 separately switchable light circuits · main light source for focused light and second light source for atmospheric background light · switchable or DALI dimmable · excl. driver
 Incasso in alluminio con 2 accensioni separabili · illuminazione d'accento e luce diffusa · on off o dimmerabile DALI · escl. Convertitore
 Downlight encastré en aluminium avec 2 circuits d'éclairage commutables séparément · source lumineuse principale pour une lumière focalisée et source lumineuse secondaire pour une lumière d'ambiance on/off · ou dimmable DALI · excl. convertisseur

COZY R DOWNLIGHT

CODE	LED W	LUMEN	VERSION
573-0100RWWOXXXXO	15	470-1030	on/off
573-0100RWWOXXXXd	15	470-1030	DALI

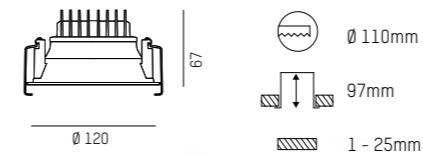

COZY R WALLWASHER

CODE	LED W	LUMEN	VERSION
573-0200RWWOXXXXO	15	470-1020	on/off
573-0200RWWOXXXXd	15	470-1020	DALI

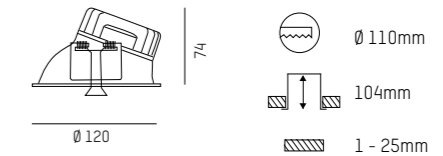

LED CONVERTER ON/OFF	V	W	PCS DRIVER	ORDER FOR
24-141126	24	24	2	1 x COZY on/off
24-141126	24	24	1	1 x COZY DALI
24-127821	24	60	2	3 x COZY on/off
24-127821	24	60	1	3 x COZY DALI
24-127824	24	120	2	7 x COZY on/off
24-127824	24	120	1	7 x COZY DALI

DOWNLIGHT



WALL



COZY R WALLWASHER
Grundlicht und Spotlicht ein
Groundlight and spotlight on



COZY R WALLWASHER
Grundlicht ein
Groundlight on



COZY R WALLWASHER
Spotlicht ein
Spotlight on

COMPLETE CODE		
R = REFLECTOR	WW = LIGHT COLOUR	XXXX = COLOUR
<ul style="list-style-type: none"> 24° chrome = 2 38° chrome = 3 24° dark chrome = 8 38° dark chrome = 9 	<ul style="list-style-type: none"> LED 2700K = 13 CRI>90 LED 3000K = 19 CRI>90 LED 4000K = 14 CRI>90 	<ul style="list-style-type: none"> white = 0505 black = 0606 copper = 1b1b gold = 1d1d



Euroshop fair stand, Düsseldorf, Germany Photo: Molto Luce

MOVA M PD

MOVA M BASIC LOFT / ROUND PD

220-240V AC

50/60Hz

Design: INHOUSE

IP20 

Hängeleuchte aus Aluminium mit MOVA M Strahlereinsatz · Schirmoberfläche glänzend lackiert · inkl. 2770mm Abhängung
 Suspension made of aluminium with MOVA M spotlight insert · glossy lacquered shade surface · included 2770mm cable
 Sospensione in alluminio con inserto per faretto MOVA M - superficie del paralume laccata lucida · compreso di cavo da 2770mm
 Suspension en aluminium avec insert de projecteur MOVA M - surface de l'abat-jour laquée brillante · 2770mm câble inclus

MOVA M BASIC LOFT PD

CODE	SYS W	LUMEN
695-390531RWWXXY01	27	2940 - 3200

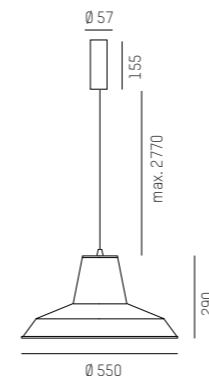





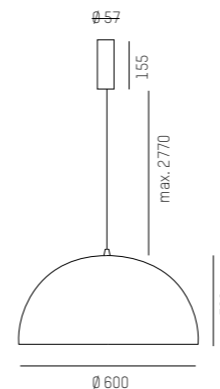



MOVA M BASIC ROUND PD

CODE	SYS W	LUMEN
695-38061RWWXXY01	27	2940 - 3200



COMPLETE CODE

R = BEAM ANGLE	WW = LIGHT COLOUR	XX = COLOUR	Y = DIMMABLE
 flood 40° = 4	 LED 3000K = 49 PREMIUM CRI>90	 white = 55	 switchable = 0
 square = 6	 LED 4000K = 24 CRI>90	 black = 66	 DALI dim = d



Private residence, Austria, Photo: Joachim Rauch

TOUCH DOWN

TOUCH DOWN PD

220-240V AC 50/60Hz Design: INHOUSE

IP20

Dekorative Hängeleuchte aus Aluminium · Oberfläche pulverbeschichtet oder lackiert · inkl. 1500mm Abhängung
 Decorative suspension, aluminium · surface powder-coated or painted · PMMA opal diffuser type · included 1500mm cable
 Sospensione decorativa in alluminio · superficie verniciata a polveri o verniciata · Variante con diffusore opale in PMMA · compreso di cavo da 1500mm
 Suspension décorative en tubulaire d'aluminium · surface laquée en poudre ou laquée · Variante avec diffuseur opal en PMMA · 1500mm câble inclus

CODE	SYS W	LUMEN
692-001010RWWXXYv1	25	2390 - 2540

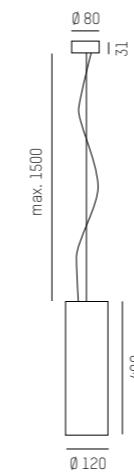

COMPLETE CODE			
R = BEAM ANGLE	WW = LIGHT COLOUR	XX = COLOUR	Y = DIMMABLE
24° medium = 5	LED 2700K = 43 PREMIUM CRI>90	chrome = 11	switchable = 0
60° flood = 9	LED 3000K = 49 PREMIUM CRI>90	white = 55	DALI dim = d
	LED 4000K = 24 CRI>90	black = 66	

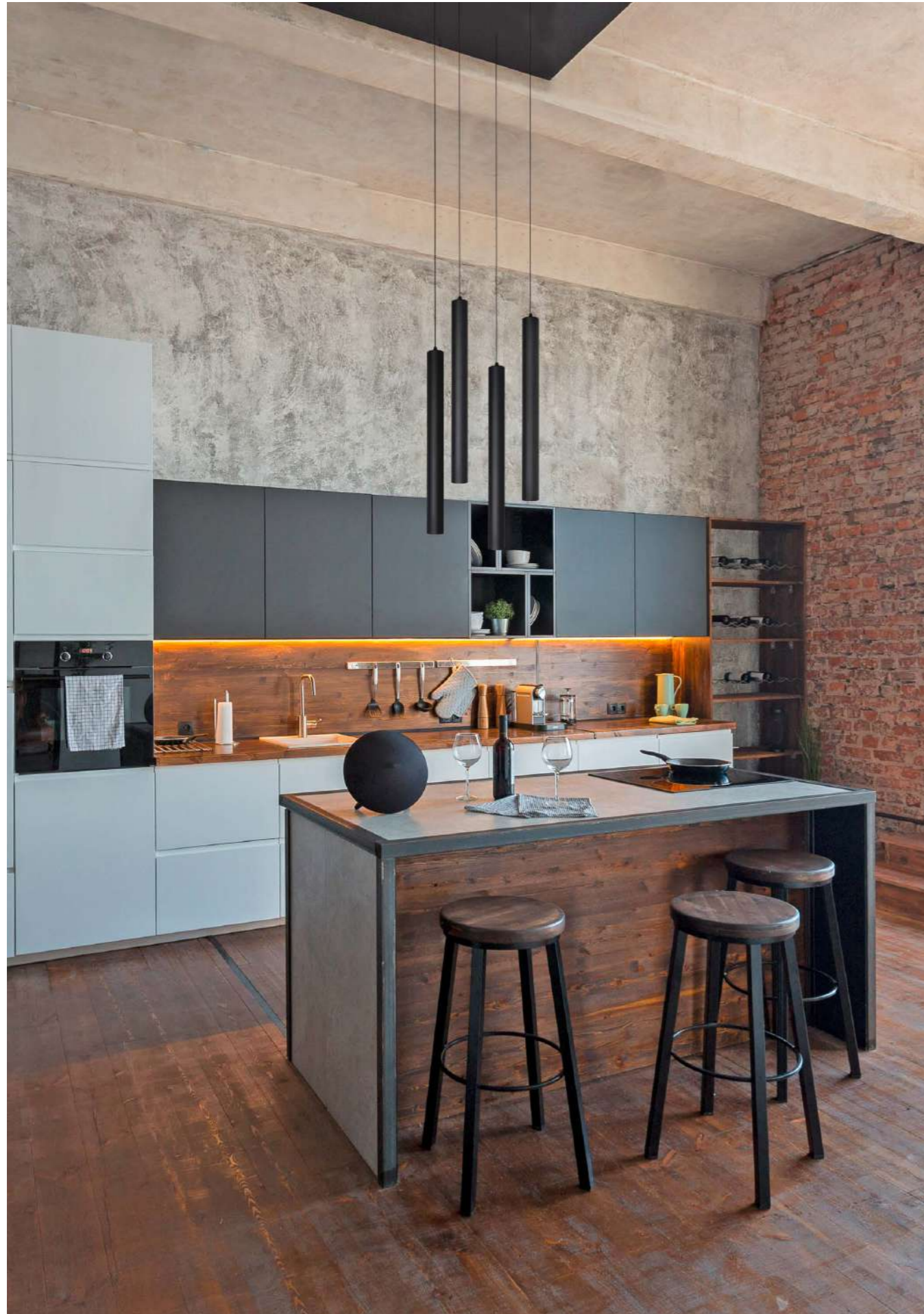

DIVO PD

IP20

DIVO PD

220-240V AC 50/60Hz Design: INHOUSE

Pendelleuchte aus Aluminium · Oberfläche pulverbeschichtet · hochwertige Kunststofflinse · 36° Ausstrahlwinkel

Pendant in aluminium · surface powder-coated · High quality acrylic lens · 36° beam angle

Sospensione in alluminio · superficie verniciata a polveri · Lente in plastica di alta qualità · Angolo di apertura del fascio luminoso di 36°

Suspension en aluminium · surface laquée en poudre · lentille en plastique de haute qualité · angle de rayonnement de 36°

DIVO SHORT PD

CODE	SYS W	LUMEN
192-20202000WWXXY	11	680-720

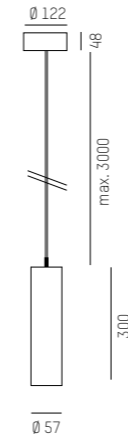

DIVO LONG PD

CODE	SYS W	LUMEN
192-20203000WWXXY	11	680-720

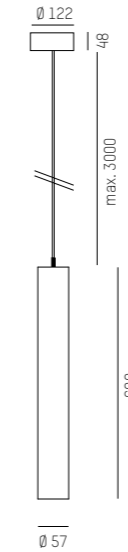

KABELHALTER / CABLE HOLDER

CODE

305-0001



SHORT



LONG



COMPLETE CODE

WW = LIGHT COLOUR	XX = COLOUR	Y = DIMMABLE
LED 2700K = 23 CRI>90	white = 55	switchable = 0
LED 3000K = 29 CRI>90	black = 66	DALI dim = d



Ideamed GmbH, Munich, Germany, Photo: Alexander Schwarz

MICA IP44 SD

MICA IP44 SD

220-240V AC / DC 50/60Hz LED 3000K / CRI>80 Design: INHOUSE

IP44  

LED Aufbauleuchte aus Aluminiumprofil · Oberfläche lackiert · Opale PMMA Abdeckung zylindrisch
 LED surface luminaire from aluminium profile · surface painted · opal PMMA diffuser curved
 Lampada LED a plafone con profilo in alluminio · Superficie verniciata · Diffusore PMMA cilindrico
 Plafonnier LED en profilé d'aluminium · surface lacquée · Diffuseur PMMA opal cylindrique

CODE	SYS W	L mm	LUMEN
520-019XY	15	606	1090
520-029XY	21	904	1640

L: 606 = 90 / L: 904 = 252

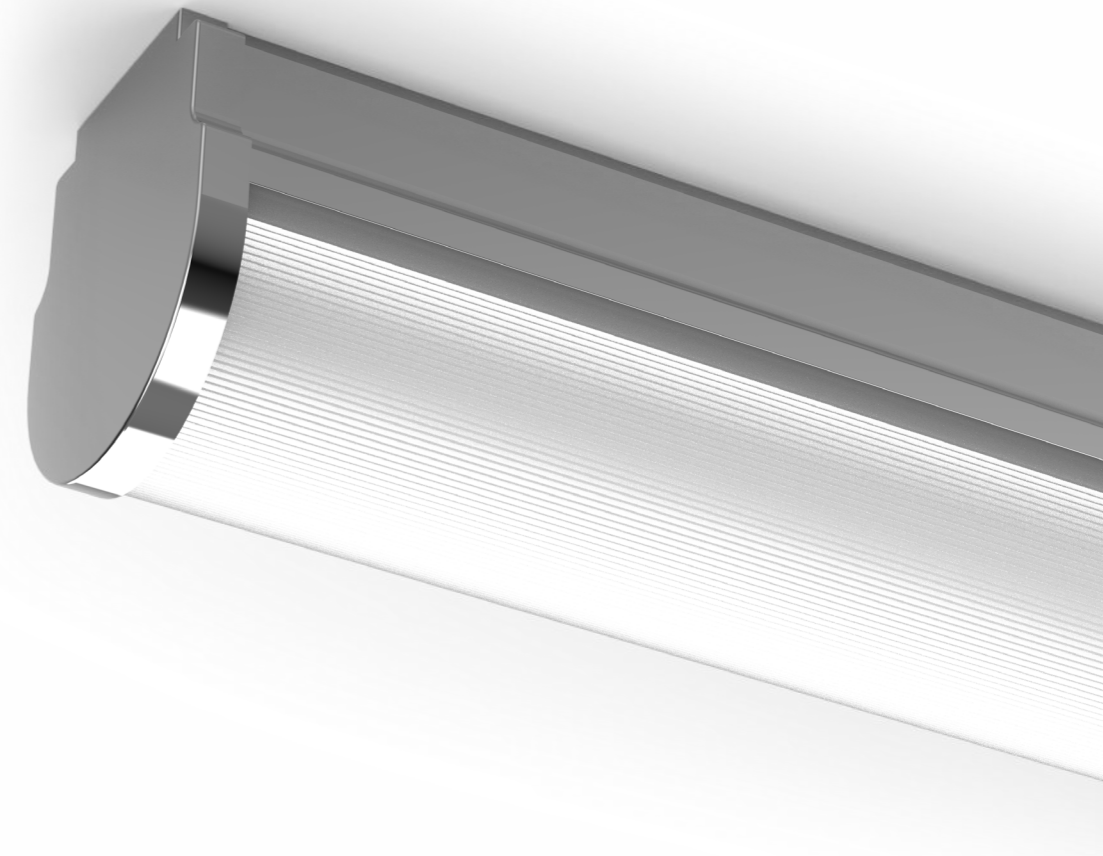
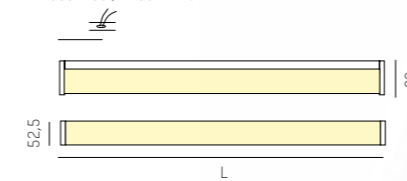

COMPLETE CODE

X = COLOUR

 chrome = **1**

 grey = **4**

YY = DIMMABLE

 switchable = **no addition**

 Analog dim 1 - 10V = **code + ad**

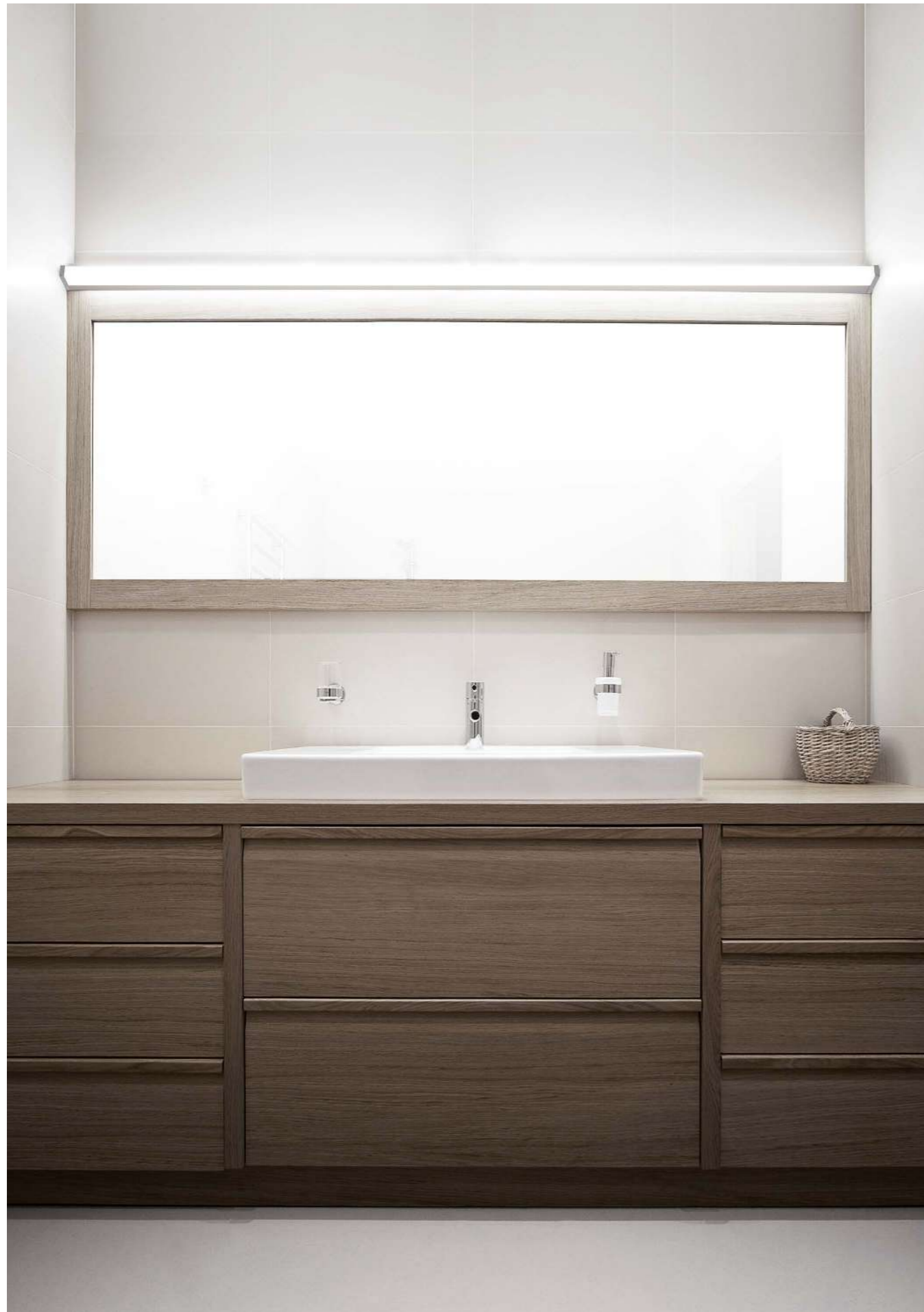

PARI SD

PARI SD

IP43

220-240V AC / DC 50/60Hz LED 3000K / CRI>80 Design: INHOUSE

LED Aufbauleuchte aus Aluminiumprofil · Oberfläche lackiert oder eloxiert · Opale PMMA Abdeckung kubisch
 LED surface luminaire from aluminium profile · surface painted or anodized · opal PMMA diffuser cubic
 Lampada LED a plafone con profilo in alluminio · Superficie verniciata o anodizzata · Diffusore PMMA opale cubico
 Plafonnier LED en profilé d'aluminium · surface lacquée ou anodisée · Diffuseur PMMA opal cubique

CODE	SYS W	L mm	LUMEN
576-019XY	15	600	1460
576-029XY	21	900	2190
576-039XY	28	1200	2920

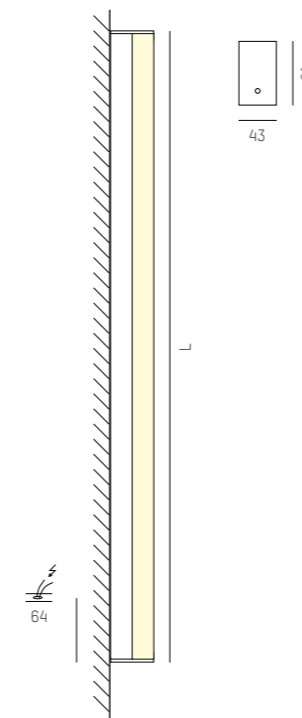

COMPLETE CODE

X = COLOUR

- chrome = 1
- white = 5
- alu anodized = 8

Y = DIMMABLE

- switchable = no addition
- Analog dim 1 - 10V = code + ad



Private residence, Austria, Photo: Joachim Rauch

VOLTO COPERTO SD

VOLTO COPERTO SD

220-240V AC / DC

50/60Hz

Design: INHOUSE

IP20 

LED Aufbauleuchte aus Aluminiumprofil · Oberfläche pulverbeschichtet oder eloxiert · Opale PMMA Abdeckung kubisch, flach oder rund
 LED surface luminaire from aluminium profile · surface powder-coated or anodized · opal PMMA diffuser cubic, flat or round
 Lampada LED a plafone con profilo in alluminio · Superficie verniciata a polveri o anodizzata · Diffusore PMMA opale cubico, piatto o tondo
 Plafonnier LED en profilé d'aluminium · surface lacquée en poudre ou anodisée · Diffuseur PMMA opal cubique, plat ou rond

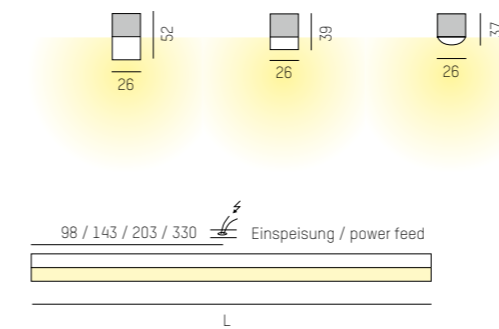

CODE	SYS W	L mm	LUMEN
539-01001C0WWXX0	11	570	680 - 810
539-01002C0WWXX0	16	850	1020 - 1210
539-01003C0WWXX0	21	1130	1360 - 1620
539-01004C0WWXX0	26	1410	1700 - 2020

nicht dimmbar / not dimmable





COMPLETE CODE



C = COVER

-  opal flat = 1
-  opal cubic = 2
-  opal round = 3

WW = LIGHT COLOUR

-  LED 2700K = 23 CRI>90
-  LED 3000K = 29 CRI>90
-  LED 4000K = 24 CRI>90

XX = COLOUR

-  white = 05
-  alu anodized = 08

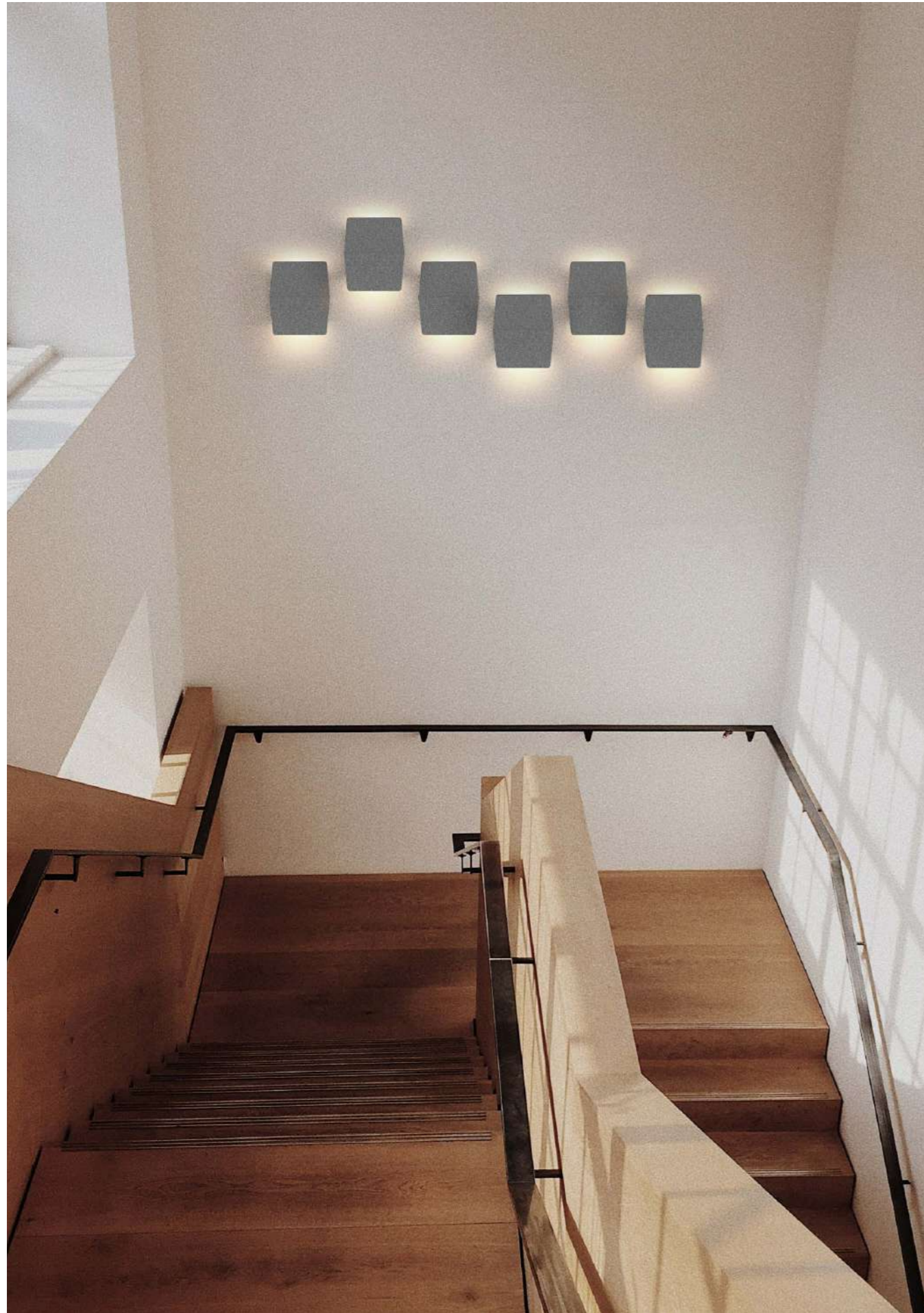

HENDRIK

HENDRIK W

220-240V AC / DC 50/60Hz LED 2700K / 3000K Design: INHOUSE

IP20

LED Wandleuchte aus Aluminium · Oberfläche pulverbeschichtet · Dekorplatte aus Filz · in 4 verschiedenen Farben erhältlich · schaltbar
 LED wall luminaire in aluminium · surface powder-coated · felt decorative plate · available in 4 colours · switchable
 Lampada LED da parete in alluminio · superficie verniciata a polvere · pannello decorativo in feltro · disponibile in 4 colori · on/off
 Applique murale LED en aluminium · surface thermolaquée · panneau décoratif en feutre · disponible en 4 couleurs · on/off

HENDRIK M W

SYS 13W	FARBE	LM
SYS 13W	COLOUR	LM
590-011120100s600	blue	350
590-011120200s600	anthrazit	350
590-011120300s600	light grey	350
590-011120400s600	seagrass	350

Lichtfarbe 2700 oder 3000K manuell einstellbar
 Light colour 2700 or 3000K adjustable
 nicht dimmbar / not dimmable

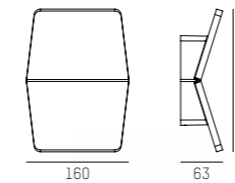

HENDRIK L W

SYS 13W	FARBE	LM
SYS 13W	COLOUR	LM
590-011130100s600	blue	240
590-011130200s600	anthrazit	240
590-011130300s600	light grey	240
590-011130400s600	seagrass	240

Lichtfarbe 2700 oder 3000K manuell einstellbar
 Light colour 2700 or 3000K adjustable
 nicht dimmbar / not dimmable

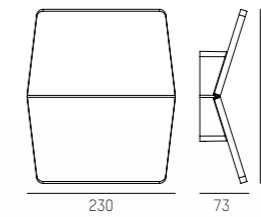

CASAMBI

CASAMBI CBU-ASD-C DALI

DALI Broadcast Gateway, max. 4 Betriebsgeräte, DALI DT6
DALI Broadcast Gateway, max. 4 driver, DALI DT6

700-0001 W



CASAMBI CBU-TED-C

Phasendimmer, Leistung: 1- 100W, 230V 50Hz
Phase dimmer, power: 1- 100W, 230V 50Hz

700-0003 W



CASAMBI SALVADOR 1000

Integriert bis zu 16 drahtgebundene DALI-Treiber nahtlos in das Casambi-System. Benötigt eine externe Spannungsversorgung für den DALI-Bus.
Seamlessly integrates up to 16 wired DALI drivers into the Casambi system. Requires an external power supply for the DALI bus.

700-0005 W



CASAMBI CLOUD GATEWAY CGW-001-POE

Für die Fernsteuerung und Echtzeitüberwachung eines Casambi-Netztes.
For remote control and real-time monitoring of a Casambi network.

700-0007 S



CASAMBI HF SENSOR

HF Bewegungsmelder, Montagehöhe: max. 5m, Erfassungsbereich: 6m, 230V 50Hz
HF motion detector, mounting height: 5m, detection range: 6m, 230V 50Hz

700-2001 W



CASAMBI PIR SENSOR

HF Bewegungsmelder, Montagehöhe: max. 5m, Erfassungsbereich: 6m, Versorgung über Dali 2 Betriebsgerät
HF motion detector, mounting height: 5m, detection range: 6m, supply via Dali 2 control gear

700-2003 W



CASAMBI CBU-A2D-E DALI

DALI Broadcast Gateway, max. 10 Betriebsgeräte, DALI DT6
DALI Broadcast Gateway, max. 10 driver, DALI DT6

700-0002 W



CASAMBI DALI 40

DALI Gateway, max. 40 Betriebsgeräte, max. 8 Gruppen, DALI DT6 & DALI DT8 einstellbar
DALI Gateway, max. 40 driver, max. 8 groups, DALI DT6 & DALI DT8 settable

700-0004 W



CASAMBI SALVADOR 2000

Integriert bis zu 16 drahtgebundene DALI-Treiber nahtlos in das Casambi-System. Verfügt über eine integrierte Stromversorgung und eine interne Echtzeituhr (RTC).
Seamlessly integrates up to 16 wired DALI drivers into the Casambi system. With integrated power supply and an internal Real-time clock (RTC).

700-0006 W



PIR WITH ENERGY HARVESING

Zur Versorgung von Sensoren, kabellosen Steuerungen und anderen Kommunikationsschnittstellen mit bis zu 70m.
For supplying sensors, wireless controllers and other and other communication interfaces with up to 70m.

700-0008 W



PUSH BUTTON

Casambi Taster mit einfacher oder doppelter Wippe, Piezo Technologie, keine Batterie notwendig
Casambi push-button with single or double button, piezo technology, batteries are not necessary

700-1001 S einfach / single

700-1002 W einfach / single

700-1003 S doppelt / double

700-1004 W doppelt / double



CASAMBI PIR SENSOR

Tageslicht- und Anwesenheitssteuerung, Montagehöhe: max. 4m, Erfassungsbereich: 8m, 230V 50Hz
Daylight and presence control, mounting height: max. 4m, detection range: 8m, 230V 50Hz

700-2002 W



LC CASAMBI

700-3001 W 60W 24V DC

700-3002 W 100W 24V DC

700-3002 W 150W 24V DC



MAXI JOLLY CASAMBI

700-3005 W 350 - 1200mA, 10 - 52 VDC, 18,5 - 62W



PROFESSIONALE CASAMBI

700-3004 W 300 - 1050mA, 10 - 36 (54) VDC, 16 - 38W



3-KANAL DIMMER / 3-CHANNEL DIMMER

700-3006 W 24V 4A /Kanal



ALL FOOD

Natürliche Farben für frisches Obst und Gemüse sowie knusprige Brot- und Backwaren sind entscheidend für ein ansprechendes Einkaufserlebnis. Doch die Herausforderung liegt darin, das perfekte Licht zu finden, welches die natürlichen Farben dieser Produkte optimal zur Geltung bringt.

Die Lichtfarbe „All food“ bietet eine innovative Lösung für diese Herausforderung, indem sie ein klares und gleichmäßiges Licht erzeugt, das die natürlichen Farben optimal zur Geltung bringt. Egal, ob es sich um warme Töne wie Rot, Gelb und Orange oder kühle Farben wie Grün und Weißgelb handelt – die „All food“ gewährleistet eine gleichbleibend hervorragende Farbwiedergabe. Dadurch werden die natürlichen Farben authentisch und äußerst ansprechend für den Kunden präsentiert. Dies steigert nicht nur die visuelle Attraktivität, sondern auch das Vertrauen in die Frische und Qualität der Produkte.

Natural colours of fresh fruits and vegetables, as well as crispy bread and baked goods, are crucial for an appealing shopping experience. However, the challenge lies in finding the perfect lighting that optimally highlights the natural colours of these products.

The "All Food" lighting colour offers an innovative solution to this challenge by producing clear and uniform light that optimally highlights the natural colours. Whether it's warm tones like red, yellow, and orange, or cool colours like green and white-yellow, "All Food" ensures consistently excellent colour reproduction. This allows the natural colours to be presented authentically and highly appealing to customers. This not only enhances visual attractiveness but also increases trust in the freshness and quality of the products.

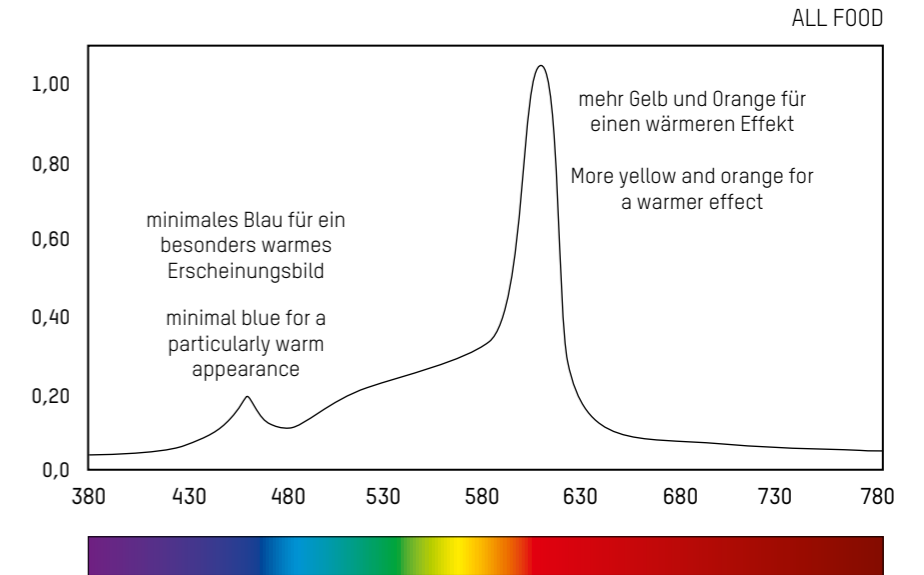

OBST & GEMÜSE / FRUITS & VEGETABLES

Der erste Eindruck zählt: Die Obst- und Gemüseabteilung ist oft die erste Station im Supermarkt und somit das Aushängeschild für Frische, Qualität und Vielfalt. Knackig grüner Salat, sonnengelbe Zitronen und strahlend rote Äpfel – die richtige Beleuchtung spielt eine entscheidende Rolle damit Obst und Gemüse in ihren natürlichen Farben erstrahlen, wie frisch geerntet.

First impressions count: The fruit and vegetable department is often the first stop in the supermarket and therefore the flagship for freshness, quality and variety. Crisp green lettuce, sunny yellow lemons and bright red apples - the right lighting plays a decisive role in ensuring that fruit and vegetables shine in their natural colours, as if freshly harvested.



BROT & BACKWAREN / BREAD & PASTRIES

Brötchen mit goldener Kruste die dazu einladen direkt zuzugreifen oder das glänzende Croissant, das an den letzten Urlaub in Frankreich erinnert – das Wecken dieser Emotionen und Erinnerungen sind ein wichtiger Teil der perfekte Produktpräsentation in der Brot- und Backwarenabteilung.

Bread rolls with a golden crust that invite you to grab one immediately or the shiny croissant that reminds you of your last vacation in France - evoking these emotions and memories is an important part of the perfect product presentation in the bread and bakery section.



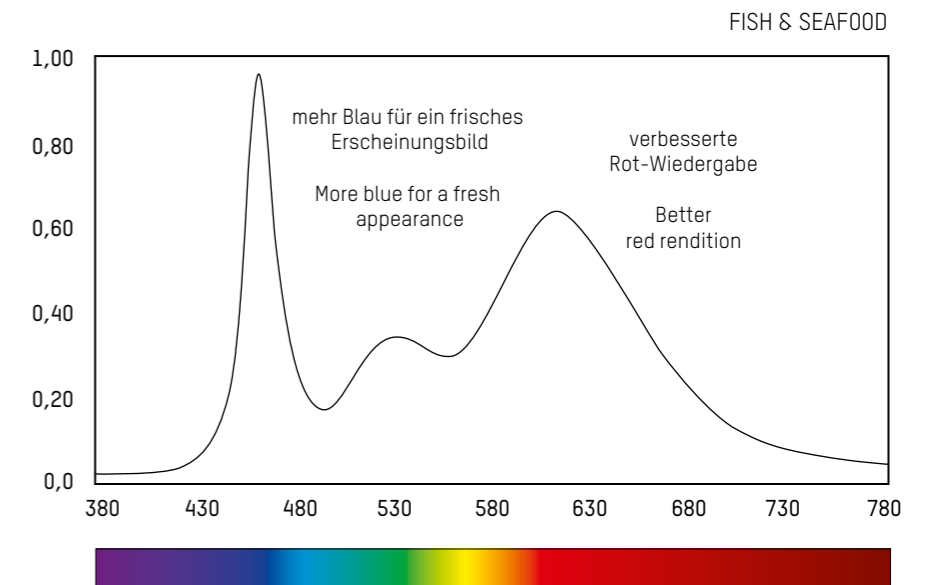
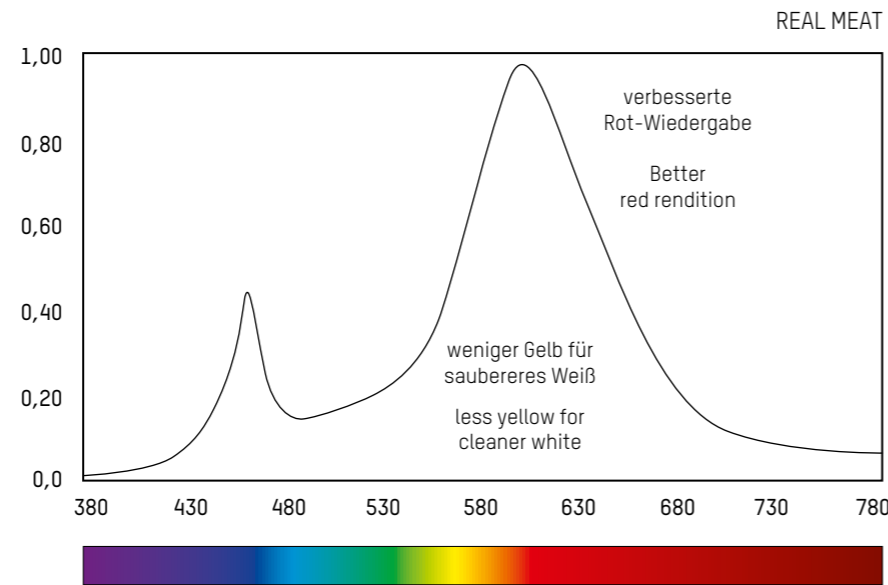

ROTES FLEISCH / REAL MEAT

Die rosarote Fleisch-Anmutung früherer Jahre, die auch die Mitarbeitenden an der Fleisch- und Wursttheke gleich mit in ein rosiges Licht tauchte, gehört dank unserer Lichtfarbe „Real Meat“ der Vergangenheit an. Fleisch- und auch Wurstwaren werden mit hervorragender Farbwiedergabe in Szene gesetzt. Durch die sauber getrennte Rot- und Weißwiedergaben wird ein natürliches Lichtbild abgegeben, das es dem Verbraucher erlaubt, Farbunterschiede an der Ware wie z.B. Fleischmaserungen in Weiß deutlich zu differenzieren



Thanks to our "Real Meat" light colour, the pink meat look of previous years, which also bathed the employees at the meat and sausage counter in a rosy light, is a thing of the past. Meat and sausage products are presented with outstanding colour reproduction. The clearly separated red and white renditions produce a natural light image that allows the consumer to clearly differentiate colour differences on the goods, such as meat grain in white.



FISCH & MEERESFRÜCHTE / FISH & SEAFOOD

Die Präsentation von Frisch-Fisch und Meeresfrüchten ist eine spezielle Herausforderung im Lebensmitteleinzelhandel. Der Anspruch an Frische und Qualität und auch das Schaffen von Vertrauen in das Vorhandensein der beiden Kernpunkte, ist essenziell in dieser Warengruppe. Eine kühle und weißliche Lichtfarbe ist hier die passende Unterstützung. Unsere speziell entwickelte Lichtfarbe „Fish & Seafood“ überzeugt durch einen verbesserten Blau- und Rotanteil sowie einem natürlichen Weiß



The presentation of fresh fish and seafood is a special challenge in food retailing. The demand for freshness and quality and also the creation of trust in the presence of these two key points is essential in this product group. A cool and whitish light colour is the right support here. Our specially developed "Fish & Seafood" light colour impresses with an improved blue and red component as well as a natural white.

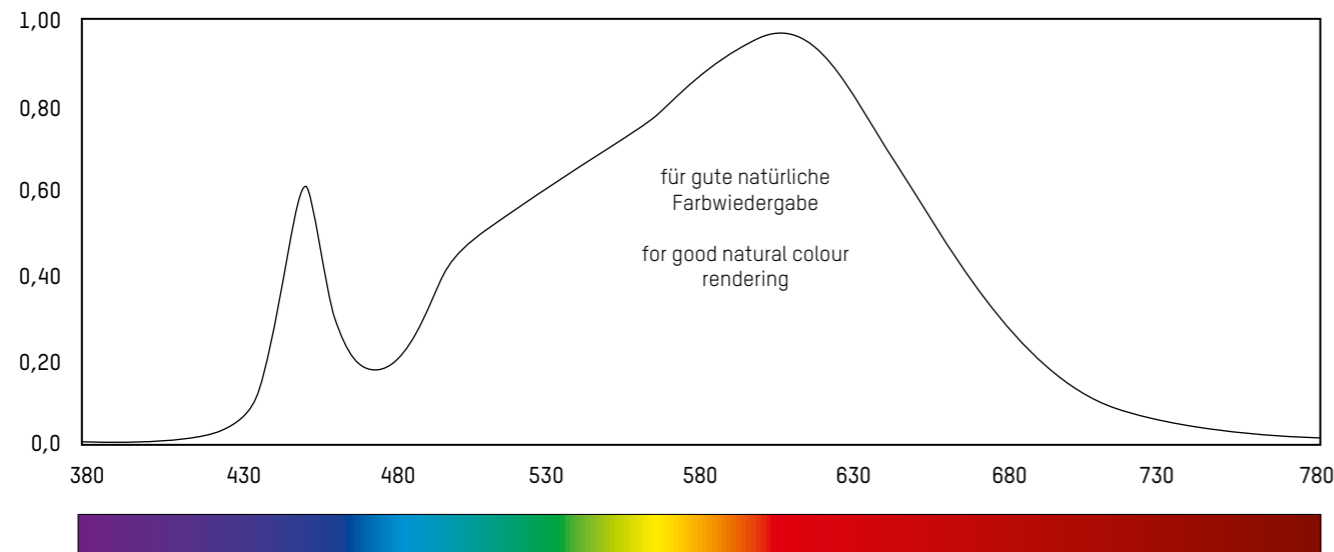

PREMIUM CRI>90

**PREMIUM CRI>90**

Unsere Standard-LEDs bieten den besten Kompromiss aus Effizienz und Lichtqualität. Dank der ausgezeichneten Weißwiedergabe und einem erhöhten R9-Wert ermöglichen sie eine natürliche und präzise Wiedergabe von Farben. Diese Eigenschaften garantieren, dass Produkte in einem klaren und authentischen Licht erstrahlen

Our standard LEDs offer the best compromise between efficiency and light quality. Thanks to excellent white rendering and an increased R9 value, they enable a natural and precise reproduction of colours. These properties guarantee that products shine in a clear and authentic light.



CRI>80



PREMIUM CRI>90

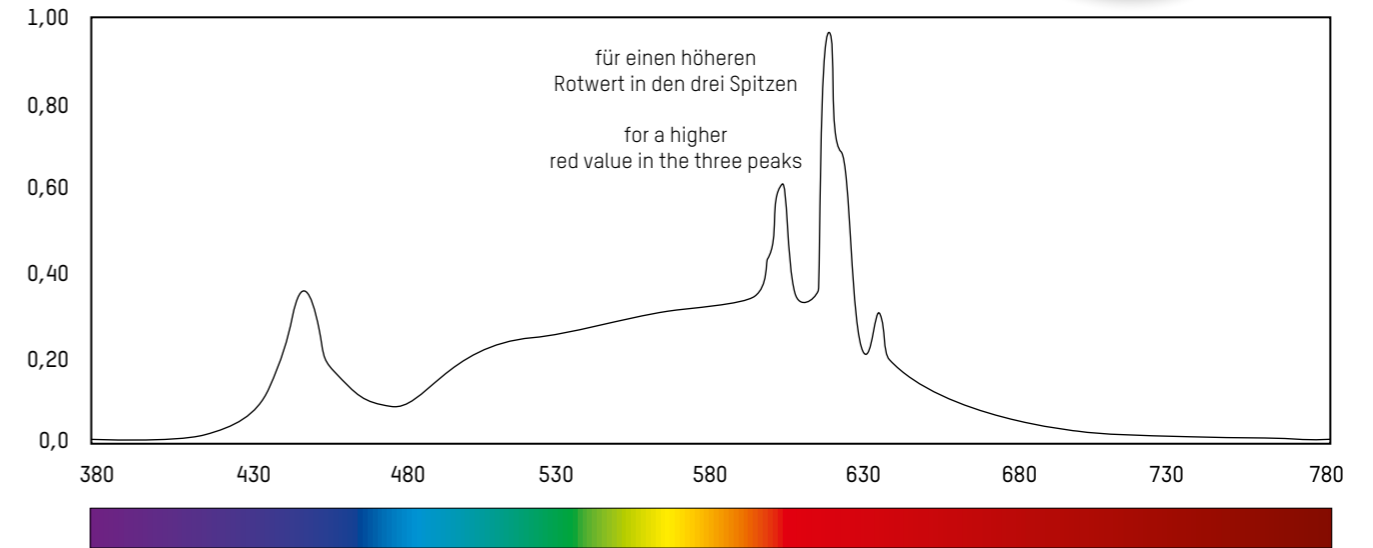

TRIGAIN

**CRI HE>90 TECHNOLOGIE TRIGAIN ®
HIGH EFFICIENT-COB FÜR NOCH MEHR EFFIZIENZ**

1. Mit der Integration dieser Innovation erzielen wir nicht nur einen höheren Rotwert, mit drei Spitzen im roten Bereich, sondern auch eine bemerkenswerte Steigerung des Farbwiedergabeindex (CRI).

2. Diese Technologie ermöglicht einen erheblichen Anstieg des R9-Werts. Von vorherigen Werten von 50-60 erreichen wir nun beeindruckende 70-90. Diese Entwicklung ist besonders wichtig, da gesättigte Rottöne in vielen Anwendungen eine Schlüsselrolle spielen, in denen eine genaue Farbwiedergabe erforderlich ist.

3. Durch die Implementierung dieser Innovation können wir nicht nur eine bemerkenswerte Effizienzsteigerung von bis zu 20% erreichen, sondern auch einen bedeutenden Schritt in Richtung Nachhaltigkeit machen. Diese Verbesserungen führen nicht nur zu Einsparungen bei den Energiekosten für unsere Kunden, sondern tragen auch dazu bei, die Umweltbelastung zu reduzieren. Indem wir energieeffiziente Lösungen vorantreiben, tragen wir aktiv dazu bei, den ökologischen Fußabdruck unserer Produkte zu minimieren und eine grünere Zukunft zu gestalten.

4. High Efficient-COBs haben sich bereits als Standard in unseren hochwertigen Produkten der Serien MOVA und Artis etabliert. Die Integration dieser Technologie ist ein Beweis für unser kontinuierliches Streben nach Exzellenz und Innovation. Unsere Kunden können sich darauf verlassen, dass sie Produkte erhalten, die auf dem neuesten Stand der Technik sind.

**CRI HE>90 TECHNOLOGIE TRIGAIN ®
HIGH EFFICIENT-COB FOR EVEN BETTER EFFICIENCY**

1. With the integration of this innovation, we not only achieve a higher red value, with three peaks in the red range, but also a remarkable increase in the colour rendering index (CRI).

2. This technology enables a significant increase in the R9 value. From previous values of 50-60, we now achieve an impressive 70-90. This development is particularly important as saturated reds play a key role in many applications where accurate colour reproduction is required.

3. By implementing this innovation, we can not only achieve a remarkable increase in efficiency of up to 20%, but also take a significant step towards sustainability. These improvements not only lead to savings in energy costs for our customers, but also help to reduce our environmental impact. By driving forward energy-efficient solutions, we are actively helping to minimise the environmental footprint of our products and create a greener future.

4. High-quality products in the MOVA and ARTIS series. The integration of this technology is proof of our continuous pursuit of excellence and innovation. Our customers can rely on receiving products that are at the cutting edge of technology.



CASAMBI dimmbar an der Standard Schiene
CASAMBI dimmable at the standard track

Bluetooth Mesh Netzwerk direkt oder mit Gateway steuerbar
Bluetooth mesh network directly or gateway controllable

**FUNKTIONSUMFANG:
RANGE OF FUNCTIONS:**

Direktes Dimmen einzelner Strahler/ Direct dimming of individual spotlights
Dimmen in Szenen/ Dimming in scenes

Gateway bei zeitgesteuerten Abläufen notwendig
For time controlled scenes a gateway is necessary

CASAMBI APP

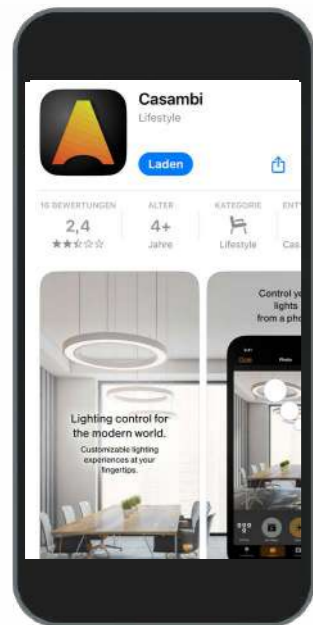

Die CASAMBI APP ist ihr System zur Lichtsteuerung, egal ob einzelne Gruppen, ganze Netzwerke, Szenen, Zeitsteuerungen und komplexe Lösungen wie Heatmapping. Die CASAMBI APP stellt ihnen alle Möglichkeiten zur Verfügung.

DOWNLOAD IM APP ODER PLAY STORE

The CASAMBI App is your system for lighting control, whether individual groups, entire networks, scenes, time schedules, or complex solutions like Heatmapping. The CASAMBI APP offers you all possibilities.

DOWNLOAD IN APP OR PLAY STORE

CONNECTIVITY

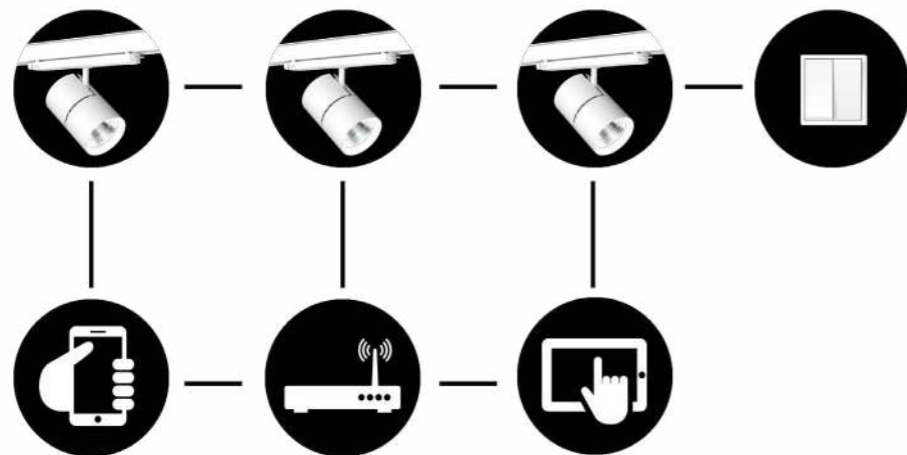

DARK REFLECTOR

Die nächste Generation an Reflektoren kombiniert Design mit verbessertem Farbwiedergabewert für ein optimales Einkaufserlebnis.
The next generation of reflectors combines design with an enhanced colour rendering index for an ideal shopping experience.

Perfekte Entblendung / Perfect Glare Control

Der DARK-Reflektor ist mit einer speziellen, von Molto Luce entwickelten Beschichtung veredelt, die in Kombination mit Mikro-Facetten des Reflektors für eine perfekte Entblendung sorgt.

The DARK-Reflector is finished with a special coating, developed by Molto Luce, which in combination with micro-facets of the reflector ensures perfect glare control.

Erhöhung des Farbwiedergabewertes / Increasing Colour Rendering Index

Zusätzlich sorgt diese spezielle Beschichtung für eine Erhöhung des Farbwiedergabewertes (CRI) um 4% im Vergleich zu einer Standard Aluminium Beschichtung. Der Vorteil eines erhöhten CRI ist, dass die Ware farbtreu, fast wie unter Sonnenlicht, wiedergegeben wird.

In addition, this special coating increases the color rendering index (CRI) by 4% compared to a standard aluminum reflector. The advantage of an increased CRI is that the goods are rendered true to colour.

Mehr Rotlicht / More Red light

Die Darstellung des Spektrums zeigt den Unterschied zwischen dem Dark-Reflektor und einem herkömmlichen Reflektor. Wie man gut erkennen kann, wird durch den Dark-Reflektor der Rotlichtanteil um 10% erhöht.

The display of the spectrum shows the difference between the dark reflector and a conventional reflector. As you can clearly see, the dark reflector increases the proportion of red light by 10%.

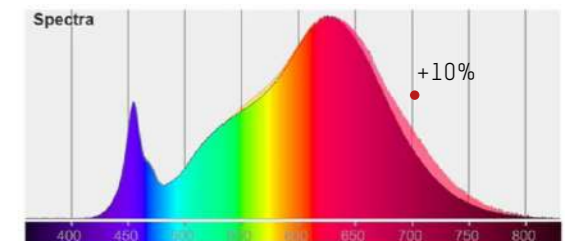

Einsatzbereiche / Areas of application

In Kombination mit der perfekten Entblendung und dem einzigartigen Kalt- und Warmerscheinungsbild, ist der DARK-Reflektor die perfekte Beleuchtungslösung für Einsatzbereiche wie Shops, welche Lederartikel wie zum Beispiel Handtaschen oder auch Schmuck anbieten. Im Architekturbereich kann durch den Einsatz des DARKReflektors eine neuartige Lichtstimmung geschaffen werden, was besonders in Restaurants oder Bars eine essentielle Rolle spielt. Durch die dunkle Beschichtung wird zwar circa 40% des Lichtes absorbiert, allerdings schafft dies gerade in diesen Anwendungsbereichen eine stimmungsvolle Umgebung. Eine weitere Besonderheit des DARK-Reflektors ist, dass man die Lichtpunkte durch die spezielle dunkle Beschichtung nicht wahrnimmt und nur schwer ausmachen kann, woher das Licht stammt. Der Reflektor erscheint im ON- sowie im OFF-Zustand annähernd gleich, daher erkennt man den Unterschied erst bei direktem Blick in die Lichtquelle.

In combination with the resulting perfect glare control and the unique cold and warm appearance, the DARK-Reflector is the perfect lighting solution for shops that offer leather items, handbags or jewellery. The DARK-Reflector with its specific light is a perfect solution in the architectural field in order to create an optimal atmosphere for example in restaurants or bars. Although the dark coating absorbs around 40% of the light, this is exactly what is needed in order to create the perfect mood. Another innovation of the DARK-Reflector is that with the special, dark coating the luminaries cannot be seen, and it is difficult to perceive where the light comes from. The reflector almost seems alike, no matter if it is switched on or off. The real difference can only be detected by looking directly into the light source.

BINNING

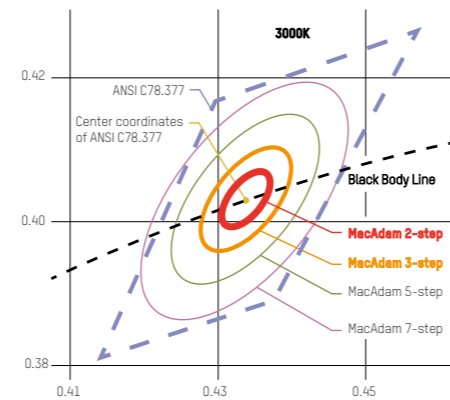

Produktionsbedingt gibt es bei der Herstellung von LEDs immer kleine Unterschiede in Lichtfarbe, Farbwiedergabe und Helligkeit der einzelnen LEDs. Diese Unterschiede würden im Vergleich mehrerer gleicher Produkte auffallen. Um dies zu vermeiden gibt es das sogenannte Binning. Bei dieser Sortierung werden alle LEDs einzeln getestet und in Gruppen, sogenannte Bins sortiert. Ein Bin enthält nur LEDs mit gleichen Werten. Dieser Binning-Prozess wird anhand der MacAdam Ellipse durchgeführt. Diese Ellipse definiert jenen Bereich, in dem keine Unterschiede für den Menschen wahrnehmbar sind. Entsprechend dem Stand der Technik werden bei Molto Luce Produkten ausschließlich LEDs führender Hersteller mit MacAdam (SDCM) 3Step Binning verbaut.

COB - CHIP ON BOARD

Bei COB Modulen werden die LED-Chips direkt auf wärmeleitendes Material (Board) geklebt und mittels dünnen Golddrähten elektrisch miteinander verbunden. Um den mechanischen Schutz der Bauteile zu gewährleisten und weißes Licht erzeugen zu können, wird diese Anordnung danach mit einem Silikon-Phosphor-Gemisch stabilisiert. Ein wesentlicher Vorteil dieser Technologie liegt im verbesserten Wärmeübergang der LED-Chips auf den Kühlkörper (geringerer thermischer Widerstand). Ein optimiertes Wärmemanagement verbessert in der Folge unmittelbar Lebensdauer und Farbdrift der Chips. Mehrere LED-Chips können so auf einer kleinen Fläche untergebracht und kollektiv enorme Lichtströme erzeugt werden.



STANDARDLEBENSDAUER

L80/B10 50.000h Ta max=25°C

80% Restlichtstrom nach 50.000 Stunden Betrieb, unterschritten von max. 10% der Leuchten der Testreihe.
Bestimmungsgemäßer Betrieb der Leuchte bei max. 25°C Umgebungstemperatur (außer gesondert angegeben).

LICHTSTROM

Der gerechnete Lichtstrom der Leuchte wird unter Berücksichtigung aller Verminderungsfaktoren wie Temperatur, Reflektorwirkungsgrad, Schutzglas-Transmissionswert und konstruktiven Faktoren, gemäß der technischen Datenblätter und Herstellerangaben, ausgewiesen. Die im Katalog angeführten, berechneten Werte beziehen sich, wenn nicht anders angegeben, auf eine Referenzberechnung mit folgender Spezifikation: 3000K CRI 80 bei Ta=25°C

LEISTUNGSANGABEN

Im Katalog wird ausschließlich die Systemleistung (SYS) angegeben, d.h. die aufgenommene Gesamtleistung von Leuchtmittel plus der Leistung des (LED) Betriebsgerätes. Ausnahmen sind nur Leuchten die ohne Betriebsgerät geliefert werden, hier wird die LED Leistung (LED) angegeben.

Die zum Zeitpunkt der Drucklegung des Katalogs verfügbaren Daten sind teilweise berechnete Werte. Die Leuchten werden nach dem Stand der Technik laufend optimiert. Elektrische Leistungsangaben sowie Lumenwerte unterliegen einer Toleranz von +/- 10%. Durch ein zertifiziertes Institut gemessene Werte sind nach aktuellem Stand in den Produktinformationen auf www.moltoluce.com und in der Lichtplanungssoftware DIALux zu finden.

Sämtliche Inhalte in diesem Katalog entsprechen dem Stand bei Drucklegung und dienen ausschließlich zu Informationszwecken. Molto Luce behält sich das Recht vor, jederzeit und ohne Ankündigung die technischen Daten der im Katalog abgebildeten Produkte zu modifizieren. Für Farbabweichungen übernehmen wir keinerlei Haftung. Manche der im Prospekt abgebildeten Produkte sind Bildretuschen und dienen zur Veranschaulichung der Einsatzmöglichkeiten. Unsere allgemeinen Geschäfts- und Lieferbedingungen können unter www.moltoluce.com eingesehen werden.

BINNING

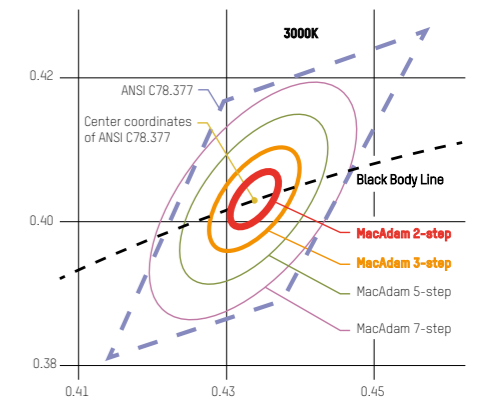
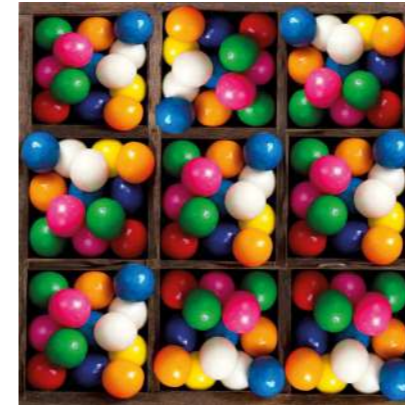

In the manufacture of LEDs, there are always small differences in the colour of the light, colour rendering and brightness of the individual LEDs. These differences would be noticeable when comparing several identical products. To avoid this, there is the so-called BINNING. Binning allows LEDs to be tested individually and separated into single groups, called BINS. A BIN contains only LEDs with the same values. This binning process is performed using the MacAdam ellipse. This ellipse defines the area where differences are not perceptible for humans. Accordingly, our products only use LEDs with MacAdam (SDCM) 3step Binning.

COB - CHIP ON BOARD

In COB modules, the LED chips are glued directly on a thermo-conducting board, and are electrically connected to each other through thin gold wires. In order to ensure the mechanical protection of the components and to produce white light, this structure is stabilized with a silicone-phosphor mixture. An important advantage of this technology lies in the improved heat transfer of the LED chips to the cooling element (lower thermal resistance). Subsequently, an optimized heat management leads directly to an improvement of lifetime and colour drift of the chips. Thus, several LED chips can be placed in a small area and enormous light streams can be collectively generated.



STANDARD LIFETIME

L80/B10 50.000h Ta max=25°C

80% residual output after 50.000 hours of operation for at least 90% of the tested luminaires.
Lamp operated as intended at max. 25° ambient temperature (unless specifically stated)

LUMINOUS FLUX

The projected luminous flux of the lamp is shown in consideration of all reduction factors such as temperature, reflector efficiency, safety glass transmittance value and constructive factors according to the technical data sheets and manufacturer's instructions. The specified, calculated values in the catalogue refer to, unless otherwise specified, a reference calculation with the following specifications: 3000K CRI 80 at Ta = 25°C

POWER RATING

Only the system performance (SYS) is mentioned in the catalogue. This means the total absorbed power of LED plus the power of the Driver. Exceptions are only luminaires that are delivered without Driver, here the LED power (LED) is specified.

Available data at time of printing of the catalogue are partly calculated values. The lights are continuously optimized according to the latest technical development, all indicated power ratings and lumen outputs have a tolerance of +/- 10%, updated information can be found on www.moltoluce.com and the professional lighting planning software DIALux.

All details provided in the catalogue comply with available data at the time of publication, and are for information purpose only. Molto Luce has the right to change/modify technical data any time without prior information. Molto Luce is not liable for colour variation. Some of the pictures are retouched and are just to show installation possibilities. See Molto Luce's business conditions and delivery terms on www.moltoluce.com

LED RETROFIT	INFORMATION	FASSUNG	WATT	KELVIN	ENERGIEEFFIZIENZ	ART.NR.
LED RETROFIT	INFORMATION	SOCKET	WATT	CELVIN	ENERGYEFFICIENCY	CODE
	ST64 / MASTER VLE LED Bulb klar	E27	6W	927	D	30-347960
	A60 / CorePro LED Bulb klar	E27	4W	827	F	30-347168
	A60 / CorePro LED Bulb klar	E27	7W	827	E	30-380035
	G120 / MASTER VLE LED Bulb klar	E27	6W	927	D	30-347984
	A60 / MASTER VLE LED Bulb klar	E27	6W	922-927	D	30-449718
	G200 / Classic LED Bulb gold	E27	7W	818	F	30-313781

LED RETROFIT	INFORMATION	FASSUNG	WATT	KELVIN	ENERGIEEFFIZIENZ	ART.NR.
LED RETROFIT	INFORMATION	SOCKET	WATT	CELVIN	ENERGYEFFICIENCY	CODE
	A60 / Master LED Bulb mirror	E27	7W	827	E	30-361225

LED RETROFIT	INFORMATION	FASSUNG	WATT	KELVIN	ENERGIEEFFIZIENZ	ART.NR.
LED RETROFIT	INFORMATION	SOCKET	WATT	CELVIN	ENERGYEFFICIENCY	CODE
	A60 / Master LED Bulb clear	E27	4W	822-827	F	30-449671
	A60 / Master LED Bulb matt	E27	7W	922-927	D	30-324930
	A60 / Master LED Bulb matt	E27	11W	922-927	D	30-325012

LED RETROFIT	INFORMATION	FASSUNG	WATT	KELVIN	ENERGIEEFFIZIENZ	ART.NR.
LED RETROFIT	INFORMATION	SOCKET	WATT	CELVIN	ENERGYEFFICIENCY	CODE
	B35 / CorePro LED Candle	E14	2W	827	E	30-377578
	CorePro LED Luster	E14	2W	827	E	30-347748

LED RETROFIT	INFORMATION	FASSUNG	WATT	KELVIN	ENERGIEEFFIZIENZ	AUSSTRAHLWINKEL	ART.NR.
LED RETROFIT	INFORMATION	SOCKET	WATT	CELVIN	ENERGYEFFICIENCY	BEAM ANGLE	CODE
	Core Pro LED Spot	GU10	4W	827	F	36	30-752531
	Master LED Spot VLE	GU10	4W	827	F	36	30-312289
	Master LED Spot Expert Colour	GU10	4W	930	G	25	30-707517
	Master LED Spot Expert Colour	GU10	4W	930	G	36	30-707579
	Master LED Spot Expert Colour	GU10	5W	922-927	F	36	30-708118
	MASTER LED SPOT VLE	GU10	6W	930	G	25	30-707630
	Master LED Spot Expert Colour	GU10	6W	930	G	36	30-707692
	Core Pro LED Spot	GU10	5W	827	F	36	30-752517

COLLECTED EDITION

conception and graphic design
Doris Koblmüller & Joachim Rauch, Molto Luce GmbH

Ein herzliches Danke gilt all unseren Partnern, die uns bei der Realisierung dieses Kataloges unterstützt haben. Insbesondere auch jenen Firmen und Architekten, die uns aussagekräftige Projektfotos zur Verfügung gestellt haben.

Sämtliche Inhalte in diesem Katalog entsprechen dem Stand bei Drucklegung und dienen ausschließlich zu Informationszwecken. Molto Luce behält sich das Recht vor, jederzeit und ohne Ankündigung die technischen Daten der im Katalog abgebildeten Produkte zu modifizieren. Für Farbabweichungen übernehmen wir keinerlei Haftung. Manche der im Prospekt abgebildeten Produkte sind Bildretuschen und dienen zur Veranschaulichung der Einsatzmöglichkeiten. Unsere allgemeinen Geschäfts- und Lieferbedingungen können unter www.moltoluce.com eingesehen werden.

A word of thanks to all of our partners who helped with the support and realisation of this catalogue. In particular with regards to the companies and architects who provided their project photos.

All details provided in the catalogue comply with available data at the time of publication, and are for information purpose only. Molto Luce has the right to change/modify technical data any time without prior information. Molto Luce is not liable for colour variation. Some of the pictures are retouched and are just to show installation possibilities. See Molto Luce's business conditions and delivery terms on www.moltoluce.com

MOLTO LUCE
on social media



FACEBOOK



INSTAGRAM



LINKEDIN



PINTEREST



YOUTUBE

LIGHT & ROOM by MOLTO LUCE

Inspirations for Roomconcepts | Lightdesign | Architecture | Lifestyle



INSTAGRAM

WEBSITE

www.moltoluce.com

